

2015 PRICE LIST **CONFERENCE**



EFFECTIVE 15 OCTOBER 2015

Effective November 1, 2016

5.0%

Price Increase on JSI 2015 Price Lists:
Casegood (V1, V2, V3), Conference, and Seating

List Prices reflect price increase

Conference Price List - Conference & Meeting Products

General Information

Environmental Mission	2
Warranty.	3
Laminate and Veneer Characteristics	3
Samples.	4
Order Procedures	4
Quickship Program.	4
Delivery	4
Freight Damage	5
Repairs and Returns	5
Care and Maintenance.	5
Textile Information	6
COM and COL Policy	6
Guide Order Form for COM and COL	7

Textile and Leather Swatch Card Programs

Maharam	8
Momentum	9-11
Ultraleather	11
Wollsdorf	11

Fabric Grading

Arc-Com.	12
Designtex	13
Maharam	14
Mayer	15
Momentum	16
Pallas	17
Stinson	18
Ultrafabrics	19

Leather Grading

Wollsdorf	20
---------------------	----

Specification Tools 21

GSA Terms and Conditions 22

Contemporary/Transitional

Conference & Meeting Room Products

Apogee	27
Meeting Tables.	38
Credenzas	39
Modular Credenzas	41
Modular Credenza Tops	44
Workwalls	50

Broadway 55

Conference Tables	61
Conference Tops	62
Conference Table Bases	64
Lectern	65
Visual Board.	65
Credenzas	66
Modular Cabinets	67
Vertical Storage Units	67
Storage Overhead TV Cabinet.	69
Cornice Top	69

Collective Conference	71
Conference Tables	84
Conference Tops	144
Conference Bases	148
Center Console Options	156

Collective Presentation	159
Media Wall	168
Interactive Wall	178
Complementary Products	179

Finale	197
Conference Tables	203
Conference Tops	204
Conference Table Bases	206
Lectern	208
Visual Board.	208
Credenzas	208
Vertical Storage Units	209

iXY	213
Table Desks	222
Storage Cabinets	226

Shuffle	231
Conference Tables	237
Conference Tops	238
Conference Table Bases	240
Lectern	242
Visual Board.	242
Credenzas	242
Vertical Storage Units	243

Vision Laminate	245
Conference Tops	250
Conference Table Bases	254
Lectern	257
Visual Board.	257
Credenzas	258
Vertical Storage Units	259

Veneer Veneer	261
Conference Tables	268
Conference Tops	269
Conference Table Bases	272
Lectern	275
Visual Board.	275
Credenzas	276
Vertical Storage Units	277

Traditional

Conference & Meeting Room Products

Brogan	279
Conference Tables	284
Conference Tops	286
Conference Table Bases	288
Lectern	289
Visual Board.	289
Credenzas	289
Vertical Storage Units	290

Walden	291
Conference Tables	296
Conference Tops	299
Conference Table Bases	300
Visual Board.	303
Credenzas	303

Wellington	305
Conference Tables	310
Conference Tops	314
Conference Table Bases	315
Visual Board.	319
Credenzas	319

Accessories	321
Conference Power and Data	323
Other items	327

Index	332
------------------------	------------

Environmental Mission

Our vision and goal is a sustaining supplier, manufacturer and customer for the long term protection and preservation of our environment for future generations.

MISSION

To achieve this vision, we are dedicated to ensuring the health and wellbeing of all of our partners, reducing negative impact on the environment, and maintaining price structure by increasing efficiencies and reducing consumption.

The Jasper Group family of brands, including JSI, is an international manufacturer that has been an environmentally conscious organization for more than 80 years.

We are proud to use wood as our primary sustainable material resource and all corporate policies and procedures support the efforts to “recover, recycle, reuse, repurpose, reduce, refuse, and re-engineer”. In doing this, we are committed to the conservation of the environment and its natural resources as well as encouraging our suppliers and customers to do the same. A goal of a “Sustainable Partnership”, supplier, manufacturer and customer, is essential for the long term protection preservation and sustainability of our environment for future generations.

LOCATION

Our manufacturing facilities are located in Southern Indiana. With our diverse product offering and manufacturing capabilities, we provide a single source for all of your project needs allowing you to conserve our fossil fuels and reduce greenhouse gases.

PACKAGING

We place emphasis on the minimal use of disposable packaging while still providing adequate protection to the finished product. Our corrugated packaging is recyclable, reusable, and up to 100% recycled content. We reuse or recycle more than 125 tons of corrugated material annually.

REGULATORY

All of our manufacturing facilities are in compliance with applicable OSHA regulations and meet or exceed all applicable DEM and EPA regulations for air emissions, storm water and hazardous waste disposal.

MANUFACTURING FACILITIES

Our manufacturing facilities are geared toward eco-efficiency and are encouraged to continually improve and conserve. Solid wood not used in the direct manufacturing process is recovered for the operation of our dry kilns, thus reducing greenhouse gases, the use of fossil fuels, and the burden of waste placed on landfills. Composite panels not used in the direct manufacturing process are ground and sold for use as animal bedding. In addition to other energy savings techniques, our manufacturing facilities use high efficient lighting, make use of power factor capacitors, and encourage all to conserve and reduce energy consumption and water usage. Condensation pumps are used to aid in water conservation as well as extending boiler life.

MANUFACTURING PROCESSES

Our finish processes utilize efficient spray guns and proper spray techniques to reduce wasted material. Excess finish material, solvents, and waste are recycled. Many of the assembly processes use water based glues that contain no hazardous ingredients.

TEXTILES

Many of our fabric options utilize up to 100% recycled content. Our leather alternative program includes selections that contain no toxic materials, plasticizers, heavy metals, or formaldehyde and have a 100% biodegradable back cloth. Some of the available panel fabric used, if discarded is a biological nutrient for the soil. Most of the components (foam, batting, and polycord) used in upholstered products are recyclable and contain various percentages of recycled content. Excess fabrics and leathers not utilized in the upholstery process go to recyclers and local charities for additional use.

WOOD

Wood is the most diverse, most process friendly, and most widely utilized natural resource in mankind’s history. No other natural resource can match the environmental advantages of wood, including being renewable, recyclable, natural, carbon negative, and biodegradable. Utilizing the sun’s energy, trees grow and remove carbon dioxide from the air while giving off oxygen to benefit the entire planet. Approximately 49% of wood’s dry weight is carbon and harvesting mature trees in a sustainable forest, which has slowed in the absorption of carbon dioxide, allows the photosynthetic cycle to continue at full optimization and allow for the carbon to remain sequestered. We are proud to use wood as our primary “sustainable” renewable resource.

WOOD OPTIONS

Many environmentally friendly solid wood and engineered wood options are available for quote, including: Lyptus®, Plyboo®, reclaimed woods, agricultural and post-consumer waste fiber products, soy-based resin bio-composites, etc.

INDOOR AIR QUALITY

Our goal is to reduce the impact our products will have on the indoor air quality. We practice the latest technologies and utilize a third party to assure we meet this goal. GreenGuard, one of the leaders in IAQ certification, continues to certify our product offering, awarding us the UL2818 - GreenGuard Indoor Air Quality standard.

PARTNERSHIPS

BIFMA
Business and Institutional Furniture Manufacturer Association
 USGBC
United States Green Building Council
 IIDA
International Interior Design Association
 FSC
Forest Stewardship Council
 GreenGuard

Warranty (Conference Products)

JSI warrants, to the original purchaser that each piece of furniture will be free from defects in workmanship, given normal use for a period of fifteen (15) years of single shift service. Drawer suspensions carry a life time warranty. Fabric manufacturer's warranty will apply. Electrical items not manufactured by JSI are covered for a period of one (1) year. JSI will, at its option, repair or replace any defective merchandise with the terms of this warranty.

JSI makes no expressed or implied warranties to any product and, in particular, makes no warranty of merchantability of fitness for any particular purpose.

This warranty does not cover:

- + Natural variations in color, texture of wood, and covering materials over which JSI has no control.
- + Damage created by bottom loading file drawers. File drawers are manufactured for hanging folders only.
- + Normal wear, color fastness, shrinkage, wrinkling, stretching of leather, and textiles.
- + Damage caused by transportation or installation companies.
- + Damage created by any accident, user modification, misuse of product, or neglect of product care.
- + Damage resulting from extreme climate conditions.

Unique Characteristic of Natural Woods and Veneers

JSI uses high quality wood and veneer harvested from sustainably managed forests. Every tree has unique and defining characteristics, like fingerprints. These characteristics can be defined by differences in color, grain configuration, and textures. These characteristics will be more noticeable if the product has a clear or lighter finish.

Maple and Cherry species have a higher degree of uneven distribution of grain, small color streaks, and pin knots.

At JSI, we take care of selecting woods and veneers that are used in our products. With this in mind, we hope you appreciate the beauty of each tree's fingerprints. Products will not be replaced due to these natural characteristics.

Veneers can be sliced in a variety of ways to create unique patterns. JSI uses several different patterns, as shown below.

Flat (Plain) Cut as shown in diagram



Quarter Sliced as shown in diagram

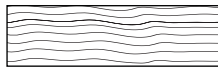

Double Cut as shown in diagram



Double Cut

The Double Cut veneer is a processed product that has at least two cuttings to create the final veneers. These cuts of veneer strands are dyed and layered into a block to create variation of patterns from a very tight grain pattern to an exotic figure grain pattern.

JSI uses select beech, cherry, maple, oak and walnut cut wood products to produce the desired look of our furniture products.

Please reference the featured highlights of each product line to identify the species and grain patterns available for that product.

Laminates (Veneer Series)

HPL (Higher Pressure Laminate) laminates can be specified on most of our work surface tops in most of our product lines. Refer to the specification pages for each series. The specification pages will also list the available coordinating finishes. HPL is .050 thick for maximum durability.

Laminate Series

JSI laminate series offer a full laminated product with imprinted grain to hide finger prints and provide durability. The worksurface tops can be specified in either a matching HPL or TFL (Thermal Fused Laminate). TFL is used on the product's chassis. Please reference the featured highlights of each product for additional details.

Finish - Top Coat

To reduce hazardous formaldehyde emissions, we use our proprietary specially designed top coat, DuraTex™. It significantly reduces hazardous formaldehyde emissions and helps improve indoor air quality.

Finish - Color/Stains

A wide range of stains are available to bring out the beautiful characteristics of each wood species. We coordinate finish color between our veneer stains and solid lumber stains; however, not all may be a perfect match. The stains are continually reviewed for accuracy of color, as well as a constant monitoring of the latest color trends in the furniture market.

Finish - Matching

Due to the natural characteristics of wood, environmental effects, and material upgrades, JSI cannot guarantee exact finish matches on existing furniture previously ordered.

If an exact match is required to accompany existing furniture, it must be specified at the time of order placement, so specific internal procedures can be followed to ensure a proper and acceptable finish match. We reserve the right to change our finish formula at any time to improve safety, quality, and appearance. Unless a finish match for existing furniture is requested at the time of ordering, we accept no liability for finish that may not match the existing furniture from prior orders.

Solid lumber may inherently have mineral streaks, pits, and various other natural occurrences. Care is taken in selecting the solid lumber to coordinate with the requested finish on our veneer products. This internal selection process is subject to availability of solid lumber parts.

Custom/Special Finishes

JSI, upon request, will accommodate special finishes. A written request is required to proceed with custom finish orders. A sample reference is required for first time matches and must be included with the written request.

There is a one time charge of **\$289 list per order** for any non-standard wood finish.

Orders will be entered noting the special finish. A sample match will be provided to the customer. Written approval is needed before the finish process can be started. Delays in approval may have an impact on lead times.

Every effort will be made to create the requested match; however, an acceptable match may not be possible because of natural variations of wood. These natural variations can also cause minor differences in the final finish product.

Samples

Samples of standard wood finishes, paints colors, metal colors, and standard laminate are available upon request. The fastest way for requests to be filled is by using our website. See below for options to request samples.

Website – jsifurniture.com (click the resource tab)
 JSI Sales representatives
 Phone – 800.457.4511 – Customer Service
 Fax – 812.771.4652

Pricing

Prices found in this document or on our website are list prices in U.S. dollars for standard product delivery to one destination. Prices do not include storage, installation, or taxes. Possession of this price list does not constitute an offer to sell. Orders can only be received from approved authorized JSI dealers.

Prices and product information in this document, as well as our website, are subject to change without notice. Reference website for most up to date product offering and pricing.

Orders

Detailed specification pages are available in the price list at the beginning of each series.

Additional information may be obtained by consulting the Customer Service Department or our website.

Indicate shipping address if different from billing address.

Send Orders To:

US Mail – JSI
 225 Clay Street
 Jasper, IN 47546
 Fax – 812-482-1548
 Email – orders@jaspergroup.us.com

JSI reserves the right to make changes in dimensions, styles, or specifications if we believe these changes will improve the safety, quality, or appearance of the product.

Acceptance of orders will be subject to credit approval, barring any acts of governments, or any other causes beyond our control (e.g. strikes, fire, embargo of materials, etc).

Product Modifications

While we offer a wide range of products to accommodate many possible solutions, we also recognize the needs for our products to be modified from our standard offering.

In the series introduction section of each product, we address modification options for that series.

To see if the desired modification is possible, please contact our Customer Service Department for a quote. Note that order quantities and material availability can affect the quote. Additional information may be requested to fully quote modifications.

Order Acknowledgments

All orders will be acknowledged promptly, showing how the order was entered, shipping time, and other information pertinent to the order. It is the purchaser's responsibility to verify all the information on the acknowledgment carefully and notify us immediately, in writing, of any discrepancies.

Published ship dates are contingent upon adverse conditions; however, every effort is made to ship as acknowledged.

Order Cancellations

All cancellations must be made in writing. Administration and/or labor charges may be incurred by the purchaser depending upon the stage of the order. Orders cannot be canceled after the finish process has begun without incurring substantial re-stocking charges.

Once production has begun on product modifications or special finishes the orders cannot be canceled. Items purchased specifically from our vendors for the order, such as textiles or laminates, are subject to our vendor's cancellation terms and re-stocking fees.

Order Changes

All changes to an order must be in writing and dated. Order changes are subject to our ability to conform. Administration and/or labor charges may be incurred by dealer depending upon the stage of the order. No change can occur once production is started.

Quickship

Items indicated with a Quickship symbol  ship within 10 business days of receipt of a clean, credit approved purchase order. Product for up to 10 offices or 10 tables can be selected from the Brogan, Finale or Vision series. See individual product pages for those models available on quickship. Available capacity is filled by orders as they are received. If normal 10 day Quickship is not available because capacity has been filled, you will be immediately notified. Changes and cancellations to Quickship orders are not allowed under any circumstances.

Delivery

Our freight policy consists of prepaid freight to the 48 contiguous states; all other shipments prepaid to port of exit ONLY. JSI reserves the right to select the appropriate carrier and shipment routes. Standard deliveries require docks that can accommodate 75 foot trucks. Pricing in this book is for standard delivery. Standard delivery does not include non-dock delivery, inside delivery, residential delivery, or installation of product. Special requests for delivery should be done at the time of ordering. See below for charges for special delivery.

Orders of less than \$1,000 net will be accessed a handling charge of \$75 net per order.

Any charges arising from failure to meet shipment, re-routing while in transit, or carrier storage charges are the responsibility of the customer.

Contact Customer Service to inquire about skidding of products, special crating of products, blanket wrap services, and product installation. These requests must be made at the time of order.

Freight Damage

JSI products are packed in cartons and meet or exceed existing codes for furniture and seating products. All shipments are delivered to the carrier in good condition and our liability ceases thereafter. If delivery arrives short or damaged, contact the carrier immediately to file a claim. In the event of concealed damage, notify the carrier and request immediate inspection. Failure to file a claim within 15 days after receipt of merchandise constitutes acceptance and a waiver of any such claims. Please inspect merchandise immediately upon receipt, otherwise there is no recourse. Keep all cartons and packing material, discarding these materials may negate your claim.

Storage of product in areas of uncontrolled humidity and temperature may cause damage to the product and void the JSI warranty.

Repairs

JSI will not issue credit allowance for any type of repairs without prior written consent.

Sales order, product model numbers, and reason for repair will be expected in order to process the repair request. A digital photo will help to expedite the request. JSI reserves the right to recommend solutions for repair.

Returns▲

No merchandise may be returned to JSI without a signed Return Good Authorization (RGA) form issued by our Customer Service Department. Any authorized return not due to damage or defect will be accessed a 45% restocking fee and all return freight charges must be prepaid. Additional restocking fees may apply for any modification, special or custom built product.

Liability for defective merchandise shall be limited to replacement or repair.

Under no circumstance can we accept COD (Cash On Delivery) returns. Any such shipment will be refused.

Replacement Parts

Obtain information and pricing on replacement parts by contacting Customer Service. Please have the model number available when requesting replacement parts. Additional information may be required to ensure proper replacement parts.

Care and Maintenance

Care of Upholstery Surfaces

Cleanability will vary based on the fabric type. For best results, a professional service is recommended. Dirt and crumbs may be gently brushed or vacuumed off. Spills should be wiped up immediately with a cloth. Vinyl textiles can be cleaned with warm soapy water and then wiped down with a warm damp cloth. For more details on any JSI carded fabric and vinyl, please visit our website at jsifurniture.com or consult the back of the appropriate swatch card for cleaning codes and any specific instructions. For COM materials, consult with the individual textile manufacturer for cleaning codes and any specific instructions pertaining to your particular fabric.

Maintenance of Mechanical Parts

Clean any lint or debris from the moving parts of the base mechanisms. Mechanisms have been designed and tested to not require lubrication under normal conditions; however, lubricant can be used if needed.

Care of Wood Edges and Veneer Surfaces

Clean all surfaces frequently with water dampened soft cloth, moving the cloth with the grain direction. Immediately remove any liquids that come in contact with wood surfaces with a blotting action to absorb liquid. Buff dry. Lift objects to move them, never pull them across the finished surface. For an additional safeguard, use a protective surface pad. This will ensure a lasting finish by protecting your furniture from possible damage caused by pens, cups and sharp objects. Avoid exposure of furniture to extremes of heat and cold, or to wide humidity variances. Avoid exposure of furniture to strong sunlight. Avoid exposure of furniture to harsh solvents such as nail polish remover, acetates, etc., as it will cause finish deterioration. If using a protective glass top, place spacer pads under the glass top to allow the wood to breath.

Care of Metal Finishes

Wipe smooth powder coat finishes and textured metals with a damp cloth. For stubborn stains and grease marks, use soap and water. Lightly brush textiles metals with a soft, dry brush to remove dirt.

Fire Retardancy

At a minimum standard, all JSI upholstered products are manufactured to comply with Bureau of Electronics, Appliance Repair, Home Furnishings and Thermal Insulation-Technical Bulletin 117-2013 issued by State of California Department of Consumer Affairs. With a January 1, 2015 effective date, this standard was passed and requires upholstered furniture to be safer from the hazards associated with smolder ignition in all four (4) categories of materials, as applicable.

Compliance with more stringent codes may require special manufacturing considerations and upcharges.

California Technical Bulletin 133 (CAL 133)

JSI uses a barrier material between the foam cushioning and the upholstery cover in order to comply with CAL 133. The standard upcharge on products specified to comply with CAL 133 is \$58 list per yard of textile.

JSI has performed a series of full scale fire tests on samples - representing a variety of product styles and worst case scenarios of upholstery covers - to comply with the requirements of the state of California Technical Bulletin 133 (CAL 133). Products in compliance will be labeled that they have been manufactured to meet the CAL 133 standard. Only products with internal test data can be labeled.

Some product designs and fabric cannot be combined to comply with CAL 133. Because of this, we reserve the right to reject any request for an upholstery cover, including COM, or product style that we feel may compromise the integrity or safety of a product specified to comply with CAL 133.

Contact Customer Service for a quote if you require laboratory certification that a specific product and upholstery combination WILL PASS CAL 133. The quotation will include testing, video, and transportation charges plus the list cost of the sample.

Our standard lead time will apply to products that do not require certification. Allow an additional six weeks over the standard lead time for products that need actual laboratory certification.

The end user, specifier and/or dealer have the responsibility to make sure all products specified will meet the flammability and safety codes of the jurisdiction where the products will be located and used.

Textile Carded Programs

JSI is proud to partner with Maharam, Momentum, Ultrafabrics and Wollsdorf Leather. Please refer to the respective pages in this pricer for each of these partners. Scan the QR codes on the back of the swatch card for latest grades and other information.

Textile Grade-In Programs

For the convenience of our specifiers, we have graded in the following suppliers:

Arc Com	Pallas Textiles
DesignTex	Stinson
Maharam	Ultrafabrics
Mayer	Wollsdorf Leather
Momentum	

Please contact Customer Service for pricing grades on textiles and leathers not listed.

Indicate on purchase order if JSI is to order the fabric.

Grades and availability of fabric are subject to change without notice. Changes could include but are not limited to price increase, discontinued patterns, discontinued colors, etc. See jsifurniture.com for up to date information.

Many textiles have repeats and the additional yardage required has been factored in for textiles ordered through the JSI Carded and Grade-In Programs. We reserve the right not to match textiles with a horizontal or vertical repeat greater than 17". Additional charges may apply for textile being applied with special instructions.

Some fabric thickness may cause issue with proper upholstering of tackable wall panels or upholstery privacy screens. Please contact Customer Service, with concerns on the fabric thickness for these items.

COM Policy

Refer to the COM price column for list prices.

All yardage requirements listed in the price list, are based upon 54" plain non-directional material. The textile on most products is cut "up the roll"; refer to the check list pages for each individual series for further information.

Additional yardage may be required. Contact Customer Service for any of the following conditions to assure proper yardage:

- + horizontal repeats or vertical repeats greater than 3"
- + textile less than 54" wide off the roll
- + patterned textile to be applied a special way

To assure quick turn around and accurate calculation of yardage, please supply the following information:

- + supplier's name
- + pattern name and color name
- + the JSI model numbers and the order quantity
- + any special direction and/or special instructions

We cannot assume responsibility for defective COM delivery to us or for the tailoring quality issues some textiles may create. Bulky textiles, thin weight textiles or fiber content may not tailor well on some models.

COL Policy

Refer to the COL price column for list prices.

Customer's own leather requirements are based on an average hide of 50 square feet.

Contact Customer Service for requirements on any other sizes.

All square footage requirements are based upon usable footage. The shape of the hide and the usable footage may make it necessary for us to request additional leather.

Placing Orders with COM or COL

COM & COL orders must include the following:

- + model number where the COM or COL will be applied
- + textile/leather supplier's name
- + sample of the textile/leather attached to order
- + special application instructions

Ship COM/COL prepaid to the following:

JSI

Attn: COM Dept

932 Mill Street

Jasper, IN 47546

Make sure the supplier tags the shipment with the customer purchase order number and sales order numbers if available.

All COM/COL orders will ship at standard lead time from the delivery of the COM/COL, except for orders requiring special custom matched finishes or special application of the COM/COL.

Guide Order Form for COM and COL

1 Order information:

Acknowledgment #: _____ **Purchase Order #:** _____

JSI Representative: _____

Dealer Name/Project Name: _____

Contact: _____

Address: _____

Phone: _____ **Email:** _____

Model Number(s) Receiving COM/COL: _____

2 Select off the bolt application: *(Check one of the boxes)*

Up the roll (standard on most seating) **Railroaded**

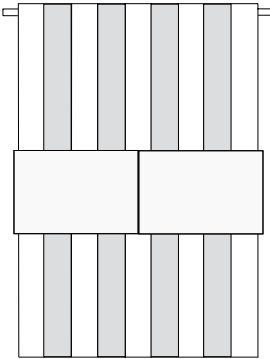
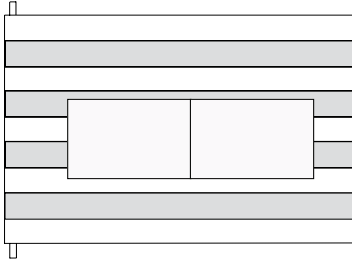
3 Additional information:

4

Attach 4" x 4" sample here.

photo copy or scan

Textile and Leather Swatch Card Program

Maharam - Value Reference 5 Card

Pattern - Bar Grade - C		Pattern - Disc Grade - C		Pattern - Oblique Grade - C		Pattern - Pick Grade - C	
Colorways		Colorways		Colorways		Colorways	
003	005	001	005	001	005	001	006
004	007	002	006	002	006	002	007
		003	007	003	007	003	008
		004		004		004	009
						005	010
Pattern - Coin Grade - C		Pattern - Divide Grade - C				Pattern - Technic Grade - C	
Colorways		Colorways				Colorways	
001	005	005	009			001	004
002	006					002	005
003	007					003	
004							

NOW!
Need it.
JSI Quickship

patterns and colors listed above are available for quickship

Maharam - Manner / Medium / Messenger / Metric Card

Pattern - Manner (MN) Grade - C		Pattern - Medium (MD) Grade - C		Pattern - Messenger (MG) Grade - C		Pattern - Metric (MT) Grade - C	
Colorways		Colorways		Colorways		Colorways	
013 Ablaze	005 Hush *	003 Alloy *	008 Pecan	077 Ash *	072 Maize *	026 Admiral	002 Fog
022 Aquatic	018 Lioness	006 Bark *	029 Pistachio *	067 Aster *	025 Mao *	020 Alligator *	013 Lava *
026 Basin *	001 Magic *	052 Blackberry	040 Pool *	041 Azure *	048 Neon *	024 Anchor *	007 Mineral
016 Butterscotch	006 Nuance	051 Cascade	016 Port *	001 Balsa *	040 Nile *	009 Arabica	014 Oriole *
019 Caper	020 Parakeet	050 Cosmic	032 Prospect *	008 Bayou *	029 Onyx *	008 Bittersweet	001 Phantom
002 Carob	009 Pathway	036 Delight *	012 Pumpkin *	085 Beyond	079 Oyster	022 Bonsai	018 Pollen *
008 Cocoa *	014 Peel	007 Espresso *	001 Raven *	045 Cactus *	080 Pensive	011 Brick	028 Scuba*
010 Cola	015 Penny *	004 Flax *	045 Sculpture	061 Capri *	060 Peridot*	017 Caramel	027 Seaport*
023 Cottage	003 Porpoise *	047 Hike	002 Smoke *	066 Cassis	024 Poppy *	012 Cardinal *	004 Sourdough
024 Dahlia	027 Schooner *	014 Laser *	048 Tangle	069 Cherry *	084 Robust	015 Cedar	023 Tar
011 Ember	007 Thicket *	022 Marina *	046 Thatched	083 Chili	071 Satsuma *	010 Cerise	005 Toffee
004 Flint	025 Vivid	053 Nasturtium	044 Washed	031 Cloud *	007 Shadow *	006 Driftwood	019 Tupelo
021 Greenway	012 Wagon	039 Nautical *	054 Wooded	038 Depth *	058 Snow *	021 Envy	025 Twilight
017 Harvest		049 Pacific		088 Electric	063 Squall *	003 Fleece	
				087 Everglade	053 Tangelo *		
				059 Fennel	006 Tobacco *		
				082 Fireside	078 Tusk *		
				076 Fossil *	062 Ultramarine *		
				081 Husk	070 Vibrant *		
				050 Hydrangea *	086 Voyage		
				046 Ice *	010 Zinc *		
				054 Lumine *			

NOW!
Need it.
JSI Quickship

**colors marked with an asterisk are available for quickship*

Textile and Leather Swatch Card Program

Momentum - Inspired Solutions

Pattern - Camber Grade - G Colorways CAM01 Anatto CAM03 Zinc CAM02 Deep		Pattern - Cover Cloth Grade - C Colorways CVR01 Antique CVR08 Platinum CVR02 Cyan CVR09 Shire CVR03 Delft CVR10 Sorrel CVR04 Graphite CVR11 Taupe CVR05 Heirloom CVR12 Vessel CVR07 Oat CVR13 Zest		Pattern - Drift Grade - G Colorways DRI01 Beacon DRI03 Stellar DRI02 Rime		Pattern - Keynote Grade - D Colorways KYN01 Granite KYN03 Palmetto KYN02 Mesa	
Pattern - Centric Grade - F Colorways CEN01 Anatto CEN02 Sediment		Pattern - Dash Grade - F Colorways DAS01 Batik DAS02 Zinc		Pattern - Jitney Grade - E Colorways JIT01 Bay JIT10 Pool JIT03 Dune JIT11 Reed JIT04 Forest JIT12 Salt JIT06 Lake JIT13 Slate JIT07 Oar JIT14 Teak JIT08 Pear JIT15 Tulip		Pattern - Torque Grade - H Colorways TRQ01 Quarry TRQ02 Tropicalia	
						Pattern - Wander Grade - F Colorways WAN01 Limelight WAN03 Sterling WAN02 Orangery	

Need it.
JSI Quickship
patterns and colors listed above are available for quickship

Momentum - Color Card

Pattern - Infinity Grade - B Colorways INF01 Aluminum INF17 Maize INF02 Aster INF18 Papaya INF03 Atoll INF19 Pewter INF04 Barley INF22 Rinse INF05 Berry INF24 Sable INF07 Capri INF25 Stucco INF08 Dove INF26 Terrain INF10 Graphite INF30 Vine INF11 Gull		Pattern - Marathon Grade - B Colorways MRN01 Alert MRN16 Noir MRN03 Caravel MRN18 Oz MRN06 Clove MRN19 Pinot MRN07 Curry MRN20 Pollen MRN08 Cyan MRN21 Rain MRN09 Deep MRN23 Sprite MRN10 Flax MRN24 Storm MRN12 Foliage MRN27 Toile MRN13 Herb MRN29 Vivacious MRN15 Marigold		Pattern - Odyssey Grade - B Colorways ODY02 Amp ODY17 Linen ODY03 Breeze ODY19 Maritime ODY06 Cedar ODY23 Primary ODY07 Craft ODY24 Roast ODY08 Cruise ODY25 Rue ODY10 Eggplant ODY26 Sangria ODY11 Emerald ODY27 Skim ODY12 Fossil ODY28 Smith ODY13 Ink ODY29 Tinge ODY15 Iris ODY30 Western		Pattern - Tradition Grade - B Colorways TRD01 Ash TRD14 Malbec TRD02 Branch TRD16 Mist TRD03 Class TRD18 Plated TRD04 Distant TRD19 Regal TRD05 Flirt TRD21 Soar TRD06 Frond TRD22 Soy TRD08 Hedge TRD24 Sprout TRD09 Hidden TRD26 Sun TRD12 Kelly TRD27 Tango TRD13 Latte TRD29 Wash	
		Pattern - Millennium Grade - B Colorways MLL02 Amber MLL20 Plateau MLL04 Cascade MLL21 Pool MLL06 Cerise MLL22 Pyrite MLL07 Clean MLL23 Safari MLL08 Coastal MLL24 Sapphire MLL10 Crisp MLL25 Spark MLL11 Electric MLL26 Steel MLL17 Onyx MLL27 Tanzanite MLL18 Orchid MLL28 Thrill MLL19 Peridot MLL30 Zinc					

Need it.
JSI Quickship
patterns and colors listed above are available for quickship

Textile and Leather Swatch Card Program

Momentum - Everyday Card

Pattern - Amuse		Pattern - Fuse		Pattern - Knack		Pattern - Syntax	
Grade - D		Grade - A		Grade - C		Grade - C	
Colorways		Colorways		Colorways		Colorways	
AMU01 Admiral	AMU03 Mocha	FUS11 Azurean	FUS06 Morel	KNA05 Brisk	KNA01 Reed	SNY01 Mahogany	SNY05 Turquoise
AMU02 Alloy	AMU04 Quartz	FUS01 Carmine	FUS07 Pepper	KNA06 Carbon	KNA03 Zest	SNY02 Nectar	SNY06 Violet
Pattern - Bangle		FUS02 Cress	FUS08 Pimento	KNA08 Filament	KNA13 Zing	SNY03 Plant	SNY07 Pewter
Grade - A`		FUS03 Ginger	FUS13 Pristine	KNA09 Fresco		SNY04 Shale	
Colorways		FUS12 Iris	FUS09 Saffron	Pattern - Lineup		Pattern - Vox	
BAN01 Baltic	BAN05 Sable	FUS04 Lunar	FUS10 Walnut	Grade - C		Grade - B	
BAN02 Cork	BAN06 Suede	FUS05 Malted		Colorways		Colorways	
BAN03 Granite	BAN07 Teak	Pattern - Habit		LUP01 Baltic	LUP05 Shadow	VOX13 Bark	VOX15 Morel
BAN04 Orchid		Grade - C		LUP02 Fern	LUP06 Spice	VOX01 Black	VOX09 Mystic
Pattern - Decode		Colorways		LUP03 Pewter	LUP07 Tranquil	VOX02 Cocoa	VOX10 Navy
Grade - C		HAB01 Aspen	HAB03 Kindle	LUP04 Sandstone		VOX03 Downpour	VOX16 Oat
Colorways		HAB02 Dune	HAB04 Pier	Pattern - Origin		VOX05 Forthe	VOX17 Snap
DEC01 Alloy	DEC03 Elm	Pattern - Insight		Grade - A		VOX08 Hot	VOX18 Turquoise
DEC02 Blaze	DEC04 Grove	Grade - A		Colorways		VOX14 Limelight	
Pattern - Free		Colorways		ORG01 Amethyst	ORG08 Jet		
Grade - C		INS11 Bark	INS10 Real Red	ORG17 Basalt	ORG23 Malt		
Colorways		INS07 Ebony	INS03 Summit	ORG18 Caraway	ORG24 Manta		
FRE01 Cocoa	FRE06 Pearl	INS08 Fossil	INS12 Wasabi	ORG19 Eureka	ORG25 Mikan		
FRE02 Evening	FRE07 Platinum	INS09 Periwinkle		ORG20 Euro	ORG26 Poppy		
				ORG22 Gaia	ORG10 Sapphire		
				ORG07 Iron			

NOW!
Need it.
JSI Quickship

patterns and colors listed above are available for quickship

Momentum - Composite Solutions Card

Pattern - Beeline		Pattern - Canter		Pattern - Cashmere II		Pattern - Kindred	
Grade - C		Grade - C		Grade - C		Grade - F	
Colorways		Colorways		Colorways		Colorways	
BEL01 Canvas	BEL12 Sisal	CNR01 Alfalfa	CNR24 Pyrite	CA132 Acorn	CA139 Olive	KND01 Chai	KND05 Mist
BEL06 Fossil	BEL13 Sprout	CNR15 Baltic	CNR09 Sable	CA128 Bone	CA136 Seashore	KND02 Flint	KND06 Orangery
BEL07 Geyser	BEL16 Walnut	CNR04 Chestnut	CNR10 Saddle	CA134 Chestnut	CA131 Smoke	KND03 Grain	KND07 Union
BEL11 Portobello		CNR06 Mica	CNR11 Safari	CA127 Ebony	CA130 Taupe	KND04 Macaw	
Pattern - Bravo II		CNR07 Night	CNR12 Sand	CA143 Fennel	CA135 Wine	Pattern - Silica	
Grade - D		CNR23 Nimbus	CNR13 Willow	CA138 Nile	CA120 Yacht	Grade - F	
Colorways		CNR08 Onyx		CA122 Ocean		Colorways	
BRV21 Bark	BRV15 Night	Pattern - EON		Pattern - EON		SIL01 Alloy	SIL20 Haze
BRV19 Black	BRV04 Ranch	Grade - C		Grade - C		SIL02 Appletini	SIL37 Jewel
BRV20 Cinder	BRV07 Saddle	Colorways		Colorways		SIL04 Bistro	SIL23 Manor
BRV23 Clay	BRV16 Sunset	EON01 Freshwater	EON05 Nocturnal	EON01 Freshwater	EON05 Nocturnal	SIL07 Brownstone	SIL24 Marigold
BRV12 Dusk	BRV01 Tumbleweed	EON02 Goldmine	EON06 Omega	EON02 Goldmine	EON06 Omega	SIL08 Burnished	SIL38 Nero
BRV02 Hematite	BRV09 Twilight	EON03 Humid	EON07 Path	EON03 Humid	EON07 Path	SIL11 Coppercrest	SIL39 Petunia
BRV17 Iron		EON04 Mystery		EON04 Mystery		SIL12 Cumulus	SIL40 Quartz
						SIL15 Gallant	SIL41 Sands
						SIL17 Ginger	SIL33 Skyward

composition solutions card patterns continued on the next page

Textile and Leather Swatch Card Program

Momentum - Composite Solutions Card (Continued)

Pattern - Silica Leather Grade - F		Pattern - Silica Tech Grade - F		Pattern - Sublime II Grade - C		Pattern - Velocity Grade - D	
Colorways		Colorways		Colorways		Colorways	
SLL01 Almond	SLL09 Hyacinth	SLT01 Calm	SLT15 Tangelo	SUB05 Agate	SUB06 Oxide	VEL01 Aloe	VEL05 Sandstone
SLL02 Aloe	SLL10 Ink	SLT02 Fog	SLT16 Tanzanite	SUB09 Beryl	SUB15 Patina	VEL02 Azure	VEL06 Snow
SLL03 Barley	SLL11 Juniper	SLT05 Macadamia	SLT10 Urbanite	SUB03 Bronze	SUB07 Peridot	VEL03 Charcoal	VEL07 Sycamore
SLL04 Chambray	SLL12 Lichen	SLT06 Mineralize	SLT11 Verdigris	SUB14 Gold		VEL04 Pond	
SLL05 Driftwood	SLL13 Madder	SLT14 Nightfall	SLT12 Vintage				
SLL06 Dune	SLL14 Pewter	SLT07 Paloma	SLT13 Willow				
SLL07 Earthen	SLL15 Raisin	SLT08 Sablewood					
SLL08 Eclipse	SLL16 Saddle	SLT09 Sandstone					

NOW!
Need it.
JSI Quickship

composite solution patterns and colors listed are available for quickship

Ultrafabrics

Pattern - Brisa Grade - E		Pattern - Pony Grade - E		Pattern - Ultraleather Grade - E		Pattern - Viva Grade - E	
Colorways		Colorways		Colorways		Colorways	
BRI36 Apple Green	BRI12 Night Navy *	PNY01 Bay	PNY05 Galacian	ULL16 Adobe	ULL20 Raven Wing	VIV01 Aluminum	VIV08 Lantern
BRI34 Ash	BRI38 Pomp. Red	PNY02 Black Forest	PNY06 Marengo	ULL10 Arctic	ULL46 Stone *	VIV02 Baha	VIV09 Lava
BRI14 Aztec	BRI19 Salsa	PNY03 Danube	PNY07 Mustang	ULL48 Baltic	ULL49 Toro	VIV03 Balsa	VIV10 Maize
BRI37 Bark	BRI39 Shiitake	PNY04 Dapple	PNY08 Shire	ULL07 Buff	ULL09 Walnut *	VIV04 Cinder	VIV11 Nublan
BRI31 Birch	BRI32 Sterling Blue			ULL47 Charcoal	ULL50 Whiskey	VIV05 Driftwood	VIV12 Poinsettia
BRI21 Black Onyx *	BRI17 Truffle	Pattern - Uccello		ULL42 Fudge	ULL45 White	VIV06 Elm	VIV13 Sugar
BRI20 Cabernet	BRI24 White *	Grade - E		ULL11 Papyrus*		VIV07 Imperial	
BRI10 Desert Clay		Colorways					
		UCC01 Beech	UCC06 Oyster				
Pattern - Brisa Distressed		UCC02 Beeswax	UCC07 Possum				
Grade - E		UCC03 Fox	UCC08 Seal				
Colorways		UCC04 Husk	UCC09 Sequoia				
BDS05 Bridle	BDS09 Saddle	UCC05 Mink	UCC10 Thicket				
BDS03 Buckskin	BDS07 Steerhide						
BDS08 Iron	BDS04 Waylan						
BDS06 Lasso							

NOW!
Need it.
JSI Quickship

*colors marked with an asterisk are available for quickship

Wollsdorf Leather Card

Pattern - FOC Earth Grade - L2				Pattern - Euroglazed Grade - L2	
Colorways				Colorways	
FOC105 Antra	FOC032 Chocolate	FOC046 Lagoon	FOC049 Spirit	EUR003 Antique Blue	EUR010 Forest
FOC026 Avocado	FOC025 Clover	FOC034 Magnolia	FOC007 Tobacco	EUR100 Black	EUR011 Mahogany
FOC001 Black	FOC035 Fawn	FOC125 Olive	FOC048 Teak	EUR009 Blackberry	EUR007 Patina Red
FOC030 Bone	FOC121 Garnet	FOC044 Orange	FOC102 Weiss	EUR008 Chestnut	EUR002 Snuff
FOC028 Camel	FOC104 Grey	FOC029 Parchment	FOC101 White		
FOC120 Campari	FOC103 Haze	FOC041 Persimmon	FOC126 Zeder		
FOC039 Caramel	FOC042 Honeydew	FOC047 Russet			
FOC146 Caribbean	FOC038 Indigo	FOC043 Saddle			
FOC037 Chateau	FOC012 Ivory	FOC031 Safari			

Arc Com Fabric Grading

For memo samples call Arc-Com at 800-223-5466

Grades and availability of fabric are subject to change without notice. Changes could include but are not limited to price increases, discontinued patterns, discontinued colors, etc. See jsifurniture.com for updated information.

Pattern	Grade	Pattern	Grade	Pattern	Grade	Pattern	Grade
Allegra	E	Fiore	G	Metro	I	Spectrum	D
Alpha	E	Fireflies	E	Mirror, Mirror	E	Spin	G
Analog	H	Forsythia	G	Monte Carlo	F	Spirit	D
Antigua	E	Francesca Wool	F	Moon Beam	E	Spot-On	F
Apex	G	Francesca Wool II	H	Moon Beam 2	E	Spotlight	G
Arashi	F	Frontier	C	Morocco	F	Spring	G
Astral	F	Galaxy	E	Murano	G	Spyro	F
Atomic	H	Gamma	E	Mystique	E	Stonehenge	G
Aurora	F	Gardenia	F	Navigator	F	Strand-It	G
Axis	F	Gatsby	D	Network	G	Strata	D
Bauble	F	Gem	D	Niagara	F	Streamline	D
Beat Box	G	Geostitch	F	Nova	G	Symphony	G
Block Party	G	Glimmer	E	Oasis	F	Tally	E
Bloom	G	Grand Central	E	Odyssey	E	Tango	F
Blossom	G	Grid	F	Ombre Petal	F	Tectonic	F
Boardwalk	E	Harlequin	G	Omega	E	Tempo	F
Bounce	G	Highlands	F	Orion	D	Terrain	D
Bourbon Street	F	Hopscotch	G	Pala	F	The Plaid	I
Brayer Flower	F	Hush	E	Palatine	E	Theory	C
Bronco	E	Iguana	E	Palatine 2	E	Trio	F
Bubbly	G	Illusion	C	Panache	E	Tritik	F
Campus Stripe	F	Illusion 2	C	Pebble Beach	D	Uptown	H
Candy Land	G	Intaglio	E	Pinball	E	Urban	G
Carnival	E	Intaglio 2	E	Pinpoint	E	Velocity	F
Casablanca	G	Intersect	E	Plateau	D	Vineyard	F
Cascade	F	Isabella	D	Polo	F	Vista	D
Cassio	E	Itajime	F	Posh	F	Volley	F
Channel	E	Jardin	H	Prism	C	Volt	J
Chit-Chat	E	Jing	E	Quad	F	Wonderland	G
Chroma	E	Jive	F	Radiant	G	Yoyo	H
Cirque	G	Juliet	I	Radius	G	Zipline	F
Clarion	F	Katano	E	Ravenna	F		
Coastline	E	Key	F	Rhythm	F		
Column	E	Kinetic	F	Ringling	F		
Compass	I	Kirigami	F	Riviera	G		
Constantine	H	Kumo	F	Robotic	F		
Contour	D	Laurel	G	Rodeo	D		
Crossroads	E	Leaflet	F	Roundabout	E		
Dakota	D	Legacy	E	Royal Garden	H		
Dakota 2	D	Leonardo	G	Sagrada	J		
Dazzle	G	Loara	F	Sahara	E		
Delphi	D	Lotus	F	Samba	F		
Delta	D	Luxe	E	Santa Fe	E		
Durango	C	Lyre	E	Savannah	F		
Dynasty	E	Lyric	G	Saxon	G		
Echo	G	Marathon	E	Sequoia	E		
Eclipse	F	Mason	F	Sherlock	D		
Empress	D	Masquerade	G	Shibori	G		
Etc.	F	Meadow	G	Shimmer	D		
Etch	E	Meridian	C	Shimmer 2	D		
Facet	J	Mesa	D	Silverado	D		

Designtex Fabric Grading

For memo samples call Designtex at 800-221-1540

Grades and availability of fabric are subject to change without notice. Changes could include but are not limited to price increases, discontinued patterns, discontinued colors, etc. See jsifurniture.com for updated information.

Pattern	Grade	Pattern	Grade	Pattern	Grade	Pattern	Grade	Pattern	Grade	Pattern	Grade
Acacia	G	Circolo	F	Henrik Small W/Knit	J	Metamorphosis	H	Rotary	I	Tweed Multi	D
Adler	E	Circumference	I	Backing	J	Metta	D	Rothestay	G	Urban Grid	G
Aggregate	F	Claire	I	Hexstripe	F	Microgrid	E	Rothestay with	H	Valanka	I
Ainsley	I	Closed Loop	F	Holmes	G	Migration	H	Backing	H	Valet	E
Aksel	F	Cobble	J	Honor Plus	I	Mingle	F	Rough & Ready II	F	Variant	I
Alcazar	E	Colorblock	G	Horizon	H	Mod	H	Round Leaves	I	Versed	D
Alchemy	E	Colorful Plaid	E	Hyphen	F	Modern Tweed	I	Rove	H	Vivid	D
Aleman	H	Concept	H	Inertia	H	Moderne	H	Rumeli	E	Volley	H
Alistair	G	Converge	G	Inga Small	I	Mohair Plus	J	Samba	H	Vox	F
Alpine	D	Cross Court	H	Inga Small W/Knit	J	Motif	F	Samba Otra Vez	H	W	F
Amaranth	H	Crosshatch	G	Backing	J	New Selkrik	H	Saugatuck	F	Westside	I
Amuse	I	Crossweave	D	Inkling	F	Nexus	H	See Saw	H	Whim	F
Annex	F	Crosswind	F	Inlet	F	Noble	D	Seed	G	Windowpane	E
Appleseed	F	Culebra	I	Inside Edge	F	Nonchalant	E	Sett	I	Winsome	E
Argiano	E	Current	F	Interlock	G	Notion	G	Shibori Stripe	G	Wire	J
Array	I	Cusco	I	Introvert	E	Omar	E	Shimmering Tide	H	Woodcut	F
Arthur	I	Cut & Paste	I	Irregular Grid	E	Ophidian	F	Signal	I	Wren	D
Aster	I	Dahlia	H	Isometry	H	Opulent	D	Singing In The Rain	D	Yoruba	G
Astrid	E	Dart	G	Isotope	F	Oscillate	G	Skye	H	Yucca	F
Banda	G	Dashing	D	Jaunt	I	Oxford Stripe	H	Sorano	D	Zhuba	F
Baratto	G	Delaine	F	Journey	I	Palomino	E	Spandau	E	Zocalo	H
Barque	J	Dharma Stripe	E	Kabuki	F	Parga	E	Spiro	G		
Battista	I	Dichotomy	H	Kalahari	E	Pennington	I	Splendor	D		
Bee	D	Dot To Dot	G	Klange	F	Phase	F	Stacks	H		
Beetled Linen	H	Draft	F	Komposition	F	Pigment	G	Starburst	G		
Beguiled By The Wild	G	Eastside	I	Lambert	G	Piiki	H	Steppe	E		
		Ellipsis	C	Lattice	H	Pika	E	Striae	E		
Big Dot	F	Eon	F	Leaf Dot	F	Pinball	I	Sugar Shoots	H		
Billiard Cloth	F	Epiphany	F	Leafette	E	Pivot	E	Swayed	J		
Billiard Panel	E	Essence	C	Leap	F	Pleat	F	Swing	J		
Birch Bark Plaid	H	Faux Sure	F	Leaves	G	Pop Art	H	Swing Set	G		
Bit	E	Florin	F	Leland	F	Porte	F	Synthesis	I		
Block Print	H	Flux	G	Linari	D	Posey	H	Tack Cloth	F		
Bolt	F	Fortuna	H	Lindos	F	Prairie	E	Tarascon	D		
Bordo	H	Friendly Faux	F	Lioret	F	Precision	F	Terrain	G		
Botanique	E	Fuse	G	Little Dot	F	Prime	D	Tesellate	I		
Boucle	F	Gale	E	Little Plaid	E	Quintessence	G	Tetris	J		
Boucle Two-Tone	E	Gallone	F	Lofty	D	Radar	F	The Last Aphid	I		
Bounce	H	Gamut	C	Lolland	I	Rail	H	Tinos	G		
Breena	E	Glaze	F	Loop To Loop	H	Razor Stripe	H	Tiny Herringbone	F		
Bunta	F	Gleam	F	Lorien	G	Refine	D	Titanium	H		
Caiman	E	Gradate	G	Ludington	C	Restore	F	To The Point	E		
Cascadia	E	Gramercy	J	Luster	F	Reuse	G	Tombolo	E		
Catalyst	F	Grandeur	D	Lydia	I	Rice	F	Top Spin	I		
Cestino	G	Griglia	F	Maglia	H	Rio Grande	F	Trace	J		
Chapiteau	E	Hashtag	E	Mandala	F	Rivergrass	F	Tramway	G		
Checker Stripe	I	Heather	G	Margin	I	Rivet	E	Transport	H		
Chevron	J	Hem Stitch	E	Match Point	I	Rivet Pearl	E	Travertine	E		
Chromatic	E	Henrietta	I	Melange	E	Rocket	D	Tumble Stones	H		
Circa	F	Henrik Small	I	Melrose	I	Rosairo	I	Tumbleweed	F		

Maharam Fabric Grading

For memo samples call Maharam at 800-645-3943

Grades and availability of fabric are subject to change without notice. Changes could include but are not limited to price increases, discontinued patterns, discontinued colors, etc. See jsifurniture.com for updated information.

Pattern	Grade	Pattern	Grade	Pattern	Grade	Pattern	Grade	Pattern	Grade
Abacus	J	Coincide High	G	Hero by Kvadrat	F	Pick	C	Strum	F
Abacus Standard	G	Performance	G	Houndstooth	I	Pick Crypton	F	Sudden	F
Acre	F	Colline by Kvadrat	F	Hum	E	Pitch	E	Surge	F
Across*	G	Colorwheel	I	Inlay 466353	I	Plait	F	Tailor	F
Akimbo	F	Column	H	by Hella Jongerius	I	Plait High Performance	G	Tally	G
Align	F	Commentary	F	Insignia	H	Plural	J	Tandem	G
Alloy	E	Compound	F	Instill	E	Ply Mesh Black/Tan	J	Teatro	H
Alpaca Herringbone	J	Confetti	J	Jacobs Coat	J	Pocket	G	Technic	C
Alter	F	Cotton Velvet	J	Kindred	H	Point	J	Tend	F
Anagram	I	Couple	H	Knot	I	Quatrefoil	J	Terrace	F
Arabesque	I	Cover	F	Lariat	E	Quick	E	Ticker	G
Aria	I	Crew	H	Latch	J	Radiant	J	Tilt	G
Array	G	Crosspatch	J	Ledger	E	Recollection	F	Tokyo by Kvadrat	H
Article	D	Crush	F	Lens	G	Reel	H	Tonica by Kvadrat	F
Balustrade	I	Cursive	J	Lift	G	Regatta	J	Tonus by Kvadratt	G
Banister	H	Cycle	F	Lineage	F	Remix by Kvadrat	F	Tonus Meadow	G
Bar	C	Dapper	E	Link	G	Repeat Dot Ring	J	by Kvadrat	G
Bar Crypton	F	Dart	G	Manner	C	Ring	G	Toostripe	J
Basel by Kvadrat	F	Dash	F	Marquee	E	Rise	I	Trait	F
Before	F	Decode	G	Matrix by Kvadrat	H	Rove	F	Transport	I
Beside	F	Defer	E	Meander	G	Rubric	F	Tread	G
Bevel	E	Design 9297	J	Mechanism	H	Rule	G	Treat	G
Bitmap	J	Disc	C	Medium	C	Runner	G	Trellis	I
Blip	H	Disc Crypton	F	Melange Tweed	I	Runner Standard	E	Tremor	F
Blumen	J	Disperse	H	Meridian	F	Salon	H	Trio	J
Bound	E	Ditto	G	Messenger	C	Scape	G	Turn	H
Boundary	F	Divide	C	Metric	C	Schema	F	Twice	F
Bridge	E	Divide Crypton	F	Micro	E	Scout	F	Twine	F
Bright Angle	H	Divina by Kvadrat	G	Mikado	J	Scribe	F	Unisol	J
Bright Cube	H	Divina MD by Kvadrat	G	Milestone	C	Scuba	E	Urban	H
Bright Grid	H	Divina Melange by	G	Mimic	G	Seam	F	Vary	E
Brim	G	Kvadrat	G	Mineral	F	Semblance	C	Vases by Hella	I
Candid	E	Division	E	Minicheck	I	Sequence	F	Jongerius	I
Canvas by Kvadrat	F	Double Triangles	I	by Alexander Girad	I	Shadowbox	G	Velvet Stripe	J
Cartouche	F	Ellipsis	F	Minimal	F	Sheen	F	Venn	G
Centric	I	Emblem	G	Mister	H	Shuttle	G	Vestige	H
Certain	F	Emboss	F	Mode	D	Shuttle Standard	E	Vineyard	I
Chalet	F	Emmesh	F	Mohair Supreme	J	Signal	F	Voyage	I
Chance	G	Exchange	E	Molly by Kvadrat	F	Silk Canvas	I	Waterborn by Kvadrat	I
Checker by Alexander	I	Facets	I	Monk's Wool	J	Skein	E	Waxen	D
Girard	I	Fasten	H	Mortise	G	Slant	F	Wedge	J
Checker Split	J	Fathom	F	Oblique	C	Small Dot Pattern	J	Weimar	H
Chenille Cord	G	Feature	F	Octave	J	Snap	J	Whirl	F
Chenille Stripe	I	Fiddle	H	Offset	G	Soft Tweed	I	Wool Rib	I
Chime	E	Floret	G	Omen	F	Sort	I	Wrap	J
Chock	G	Fluent Crypton	F	Optik	J	Stack	E		
Cinch	D	Fluted Silk	I	Orakelblume	J	Star by Kvadrat	H		
Cipher	H	Focus	E	Ottoman Stripe	J	Stature	F		
Circles	J	Fraction	G	Outback by Kvadrat	G	Steady	E		
Circuit	G	Fruit by Hella Jongerius	J	Parched Silk	I	Steady Crypton	F		
Coach Cloth	I	Garden	I	Park	J	Steelcut by Kvadrat	G		
Cobblestone	J	Glint	E	Pavement	I	Steelcut Trio	G		
Coda by Kvadrat	I	Grade	H	Paver	F	by Kvadrat	G		
Coin	C	Hallingdal by Kvadrat	G	Pebble Wool	J	Strand	G		
Coin Crypton	F	Hedge	F	Pebble Wool Multi	J	Stride	G		
Coincide	E	Helix	H	Pennant	H	Stripes	J		

Mayer Fabric Grading

For memo samples call Mayer at 800-428-4415.

Grades and availability of fabric are subject to change without notice. Changes could include but are not limited to price increases, discontinued patterns, discontinued colors, etc. See jsifurniture.com for updated information.

Pattern	Grade	Pattern	Grade	Pattern	Grade	Pattern	Grade	Pattern	Grade
Acclaim	D	Daydream	D	Holiday	E	Obi	F	Silk Screen	C
Align	C	Dazzle	D	Hombre	E	Obsession	G	Silverweave	D
All Seasons FR	C	Debonair	G	Hoopla	D	On The Spot	G	Skate	D
All Use FR	C	Debut	F	Hopsack	E	Optic	C	Sketch	C
Amadeus	G	Destiny	D	Illusion	G	Orbit	D	Slick	D
Antique	D	Destiny plus	E	Images	D	Origami	F	Smart Suede	D
Apex	C	Durablock™	E	Impulse	D	Ottoman	F	Social Network	E
Arabesque	E	Detail	E	In The Groove	D	Outback	C	Solaris	F
Aristocrat	D	Disco	E	Infinity	G	Oxen SP Black	A	Soleil	F
Array	F	Dublin Tweed FR	D	Interlace	D	Palermo	D	Solid Ground	E
Artistry	C	Durango	C	Interlochen	D	Panache	G	Sophisticate	C
Ascension	G	Duraweave® 10	B	Intrigue	D	Paparazzi	F	Source	D
Athens FR	D	Echo	D	Jekyll & Hyde	C	Pastime	E	Source plus	E
Atomic	C	Ecosphere	F	Jenga	E	Patent	E	Durablock™	E
Aurora	G	Eleanor Rigby	F	Jitterbug	E	Patio	C	Spacer Mesh	B
Avenue	F	Element	C	Journey	E	Pavilion	F	Spirograph	D
Awakening	H	Empire	I	Jubilee	D	Peerless	C	Spotlight	F
Banner	C	Emu	C	Juncture	H	Phoenix	C	Stanza	E
Bar None	E	Encore	F	Karma	F	Pinehurst	D	Stop & Go	F
Batik	C	Enigma	G	Katagami	J	Pinnacle	D	Stratosphere	H
BeBop	F	Entourage	F	Key Largo	C	Plaza	D	Suede	D
Bella	F	Entwine	D	Kismet	F	Portal	E	Swank	F
Berkshire	D	Equation	D	Kobe	C	Positive Thoughts	G	Synapse	F
Big Top	F	Equinox	D	Komodo	D	Prado	D	Tangled Web	G
Blocks	C	Erode	G	Laredo	E	Primo	D	Theory	C
Bolero	D	Escapade	G	Linen	C	Prism	C	Time Line	E
Botanica	F	Esprit	D	Links	D	Pulse	F	Toss Up	D
Boteh	J	Essex	D	Locomotion	D	Punch	C	Tributary	D
Brio	E	Europa	E	Longhorn	D	Quark	F	Turnabout	G
Bungalow	I	Evolve	G	Lunar	E	Quattro	B	Tussah	D
Burst	E	Facets	F	Madras	E	Rain Dance	E	Twister	E
Camelot	E	Factor	D	Madrid SP Black	A	Ranchero	A	Uptown	C
Canvas	E	Fairy Tales	G	Makore	F	Rapport	C	Valet	C
Caressa FR	C	Fanfare	F	Malibu	D	Ratio	F	Variant	C
Caressa Suede	C	Fantasy	F	Mandala	H	Razzmatazz	F	Venetian	H
Cascade	D	Fathom	E	Marquise	C	Realm	F	Venue	D
Catalyst	D	Figure Eight	C	Marvel	F	Rebound	F	Verona	C
Cavalier	C	Finale	D	Matrix	G	Reiki	F	Vibrant	D
Cayman	F	Finesse	C	Maverick	C	Relic	F	Viewpoint	F
Celtic	E	Finish Line	E	Maze	F	Replay	F	Vintage Mohair	I
Chaps FR	C	Flock	G	Meander	D	Reveal	D	Vinyl Stat ESD	D
Charade	G	Florentino	C	Melody	E	Reverb	C	Vogue	E
Charette	E	Flower Power	D	Metro	D	Rhythm	G	Volante	H
Circuit	H	Focal Point	C	Microdot	C	Rift	D	Wallaby SP Black	A
Circumference	G	Forte	A	Milano	D	Rock & Roll	F	Webscape	D
Collage	G	Foundation 10	B	Monogram	D	Round 'N Round	F	Whimsy	G
Component	D	Gala	F	Moonscape	C	Sakura	G	Wildflower	G
Contempo	C	Geisha	G	Mosaic	D	Samurai	F	Willow	E
Continuum	C	Genesis	C	Mosaic plus	F	Sashiko	G	Wool Boucle	G
Cork	E	Genesis plus	D	Durablock™	F	Sequel	B	Xanadu	G
Counterpoint	D	Durablock™	D	Motif	G	Sequel plus	D		
Cross Check	B	Glee	D	Myriad	F	Durablock™	D		
Crystals	D	Glimmer	E	Mystic	C	Sequence	C		
Cuddle Up	F	Groundworks	F	New Dimensions	G	Shantung	D		
Curlicue	C	Guardian	C	Nirvana	G	Sherlock	C		
Dakota	C	Haberdash	C	Nostalgia	D	Shibori	F		
Dande	E	Habitat	E	Nuance	E	Shimmer	E		
Dapper	C	Hole In One	F	Nylon-Stat ESD	E	Sierra SP Black	A		

Momentum Fabric Grading

For memo samples call Momentum at 800-366-6839

Grades and availability of fabric are subject to change without notice. Changes could include but are not limited to price increases, discontinued patterns, discontinued colors, etc. See jsifurniture.com for updated information.

Pattern	Grade	Pattern	Grade	Pattern	Grade	Pattern	Grade	Pattern	Grade
Ace	C	Cycle	D	Impact	D	Ohs II	G	Silica Leather	F
Acoustic	F	Dash	F	Imperial Mohair	J	Ona	I	Silica Reach	G
Agora II	D	Dayspell	H	Index	G	Origin	A	Silica Roam	G
Aldo	G	Decode	C	Infinity	B	Ozone	H	Silica Stride	G
Align	I	Delano	G	Infusion	F	Pace Crypton	E	Silica Tech	F
Allegory	I	Delve	I	Inner Circle	H	Pace Incase	D	Silica Waltz	G
Amenity II	G	Dive	F	Insight	A	Panorama	J	Silk Struktur	H
Amuse	D	Dividend	G	Interim	I	Parable	F	Sketching Air	G
April	F	Dogwood Leaves	E	Intermezzo	I	Parkside Crypton	F	Skip	C
Ardour II	H	Domain	F	Intermix II	D	Parkside Incase	E	Small Talk	G
Arrange	H	Drift	G	Intersect	C	Parterre	E	Solace	C
Ascend	E	Duo	F	Interval	B	Passages	I	Solo 2	D
Audio	G	Ebb	F	Isla	E	Perk	B	Soma	G
Audubon	H	Edison	H	Jardin	G	Photon	H	Sort	F
Avanti	H	Effloresce	H	Jest	F	Pierre	G	Span Crypton	E
Avenue	D	Elevate	I	Jitney	E	Ping	D	Span Incase	D
Axis	C	Elle	F	Juncture	H	Pique	D	Spin	G
Bandwidth II	F	Emanate	H	Keynote	D	Plus	F	Splendeur	J
Bangle	A	Embark	F	Kindle	F	Propensity	C	Starboard	F
Banter	H	Eon	C	Kindred	F	Prospect	D	Streamers	D
Basis	B	Essay	F	Kinney	D	Proviso	G	Strut	E
Beeline	C	Estrella	H	Knack	C	Proximity	G	Sublime II	C
Beep	E	Evolve	H	Kudos	G	Quirk	D	Substance	J
Bento	F	Expo	B	Lana	I	Raffia	I	Sway II	G
Bias	G	Feliz	G	Ledge	E	Rally	H	Symbol	I
Bloc	G	Felt	G	Lella	G	Rattan	I	Synergy	D
Boom II	D	Felt Melange	G	Lina	I	Recollection II	G	Syntax	C
Boxcar	G	Flection	G	Lineage	I	Redux	D	System	G
Bravo II	D	Fleet	E	Lineup	C	Rein II	D	Tactic	G
Brisk	G	Flow	G	Linq	I	Respite	C	Tesla	G
Buoy	G	Flux	G	Livia	J	Revolve	H	Tetra	D
Cairns	H	Focal	D	Lloyd	G	Riga	G	Tone	E
Cairo II	G	Foray	D	Lore	F	Rivet	D	Torque	H
Camber	F	Free	C	Loupe	I	Row	D	Tradition	B
Canter	C	Fringe	E	Lucio	H	Sail	H	Trefoil	I
Carlo	H	Fuse	A	Ludwig	G	Scan	I	Trove	H
Cashmere II	C	Gentry	H	Malmo	G	Scape	G	Turin	G
Catalogue	H	Geo	J	Mapping Ideas	G	Scrabble	C	Twist	G
Central	E	Golden Leaf Tree	E	Marathon	B	Scribe	D	Upside	G
Centric	F	Gradient 18	H	Marcel	H	Sense	E	Vario	D
Channel	E	Gradient 36	J	Medley	F	Sidebar Crypton	F	Veer	H
Chant	F	Gradient Solid	F	Mensa	H	Sidebar Incase	F	Velocity	D
Chipper	I	H2O	J	Method	G	Sidestep	F	Venue	D
Cinch	B	Habit	C	Millennium	B	Signet	I	Via	C
Cite	G	Hearsay	H	Mix	I	Silica	F	Viva II	E
Clang	D	Helm	F	Molto	H	Silica Andy	G	Vox	B
Classique	J	Hickory Leaf	D	Nagoya	H	Silica Breeze	G	Wander	F
Context	B	Hive	E	Neon	H	Silica Deflect	G	Waver	E
Core	B	Hue	C	Nifty	D	Silica Etch	F	Waypoint	C
Course	G	Hula	H	Nile	H	Silica Fiona	G	Weaving Palettes	F
Cover Cloth	C	Icon	D	Nimble	H	Silica Fritz	G	Whim	F
Crete	H	Idyll	G	Oath	E	Silica Hiatus	G		
Current	C	Illumina	I	Odyssey	B	Silica Hoop	G		

Pallas Fabric Grading

For memo samples call email www.pallastextiles.com

Grades and availability of fabric are subject to change without notice. Changes could include but are not limited to price increases, discontinued patterns, discontinued colors, etc. See jsifurniture.com for updated information.

Pattern	Grade	Pattern	Grade	Pattern	Grade
Abstract Chevron	F	Kwaart	G	Turtle Neck	G
Algorithm	F	Laced Up	E	Twine	D
Amari	F	Larkspur	G	Unraveled	E
Asha	F	Latifolia	G	Unspun	G
Aurora	F	Le Fleur	F	Urbanized	E
Basaltes	F	Line	F	Vespa	E
Bevel	F	Majolica	G	Whim	E
Bonnaroo	F	Marbles	F	Wonder Wheel	H
Boulevard	F	Meadowrue	F	Work Horse	F
Bounce	E	Melody Maker	F		
Busy Bee	H	Milano	G		
Carnivale	G	Modern Blaze	F		
Cell Theory	I	Mosaic	E		
Chakra	F	Off Track	E		
Chitra	E	On The Fringe	H		
Chroma	G	Painted Stripe	G		
Composition	G	Patina	E		
Criss Crossing	F	Perfect Pitch	F		
Curve	H	Petals	G		
Dapple	E	Ping Pong	E		
Deeply Rooted	H	Point	F		
Deflect	E	Polka Dotty	F		
Delphinium	G	Promenade	F		
Dot Dot Dot	G	Racy	F		
Field Play	G	Raku	F		
Flame	F	Ravenna	G		
Flexing Muscles	F	Reel To Reel	G		
Formula	G	Reverb	G		
Fortune Teller	F	Rooftops	G		
Fracture	G	Round	I		
French Crepe	F	Running Stitch	H		
Friendship Bracelet	E	Sandstone	D		
Gather	E	Seeking Truth	G		
Gene Pool	G	Sheepish	F		
Graph	D	Skip	E		
Grasmere	F	Solid Footing	E		
Grid	F	Spin Art	G		
Grill Cloth	G	Spontaneous	I		
Ground Breaking	F	Spot On	F		
H2O	F	Spun	E		
Hand-Woven	F	Stamped Out	I		
Heritage	E	Stereo Stripe	G		
Highway Patrol	E	Surface	E		
Hitch	F	Swing	F		
Holy Cow	E	Tempo	E		
Holy Cow Too	E	Terra	D		
Infinite Helix	G	The Burbs	F		
Inlay	F	Top Color	F		
Interlace	G	Transom	G		
Jacks	H	Trellis	H		
Karoke	F	Tulips	G		

Stinson Fabric Grading

For memo samples call Stinson at 800-841-6279

Grades and availability of fabric are subject to change without notice. Changes could include but are not limited to price increases, discontinued patterns, discontinued colors, etc. See jsifurniture.com for updated information.

Pattern	Grade	Pattern	Grade	Pattern	Grade	Pattern	Grade	Pattern	Grade		
Abacus	G	Channel	D	Flex	E	Liquid	E	Respite	F	Tendrill	D
Acadia Epingle	I	Chauncey	D	Flight	G	Makeover	G	Retrograde	D	Tessellate	G
Acanthus	H	Chi w/Agion	G	Flip Flops	G	Mali	G	Revolution	G	Tessuto	C
Ace	C	Chloe	F	Florentine	G	Malta	I	Revolve	H	Thicket	D
Acrobat	G	Chroma	E	Folio	G	Manchester	E	Rialto	C	Torus	F
Adirondack	F	Cielo	H	Fractal	F	Marimba	F	Riddle	D	Tracing	E
Aero	F	Cinnamon Blossom	H	Freehand	E	Marquetry	F	Rivera	F	Tranquility	H
Affinity	F	Cirque	E	Furrows	D	Martini	F	Rogue II	B	Transcend	C
Alchemy	E	Cirro	F	Fuse	C	Matrix	E	Rolling Stones	H	Trax	D
Alfresco	G	Citadel	C	Geodesic	G	Mesa	H	Salinas	I	Tribeca	C
Algiers	G	Clean Slate	D	GeoMet	E	Metro	D	San Simeon	G	True Path w/Agion	H
Alignment	G	Coco	F	Glacier	C	Mica	D	Satellite	D	Tuscan Hills	H
All American	B	Colden	F	Glisten	H	Mingle	F	Scintillate	G	Tweed	F
Aloha	H	Colorguard All	C	Gradation	E	Moccasin	C	Scout	C	Umbrian Rain	H
Apex.Crypton Revl	E	Seasons	C	Grand Sierra	C	Modena	F	Scribe	D	Up Tempo w/Agion	H
Arc	F	Comeback	G	Gravity	E	Monhegan	G	Script	D	Urban Grid	C
Archetype	E	Concentric	G	Grille	D	Montage	E	Seagrass	G	Valise	D
Arioso	E	Connect	C	Grove	G	Montana	C	Sebago	F	Vanish	H
Ascend	F	Continuum	E	Hands On	F	Moxie	F	Second Act	G	Vapor	F
Aspen	F	Core	C	Happy Hour	E	Mumbai	G	Sedona	H	Varati	I
Atlas	C	Cottonwood	G	Happy Tappy	I	Natural World	J	Sentry - HC	C	Vegas	C
Atmosphere	C	Courtyard	H	Haven	E	Naugaleather	C	Sequence	D	Velocity	E
Auberge	H	Cozy	E	Helix	H	Naugasoft	C	Shantung	C	Verdure - Envi	F
Aura	I	Cranbrook Loop	J	Hi-Fi	D	Neochrome III	C	Shift	C	Vermont	H
Avant	C	Criss Cross	C	Highlight	C	Nest	H	Sideline	E	Vibe	F
Balance Beam	G	Cruisin	H	Hive	D	New Hempstead	C	Silverado w/Agion	F	View	H
Bali	F	Crypton Suede	D	Horizons	H	Next Scene	F	Simplicity	C	Vineyard	I
Balustrade	H	Crystalline	G	Hot Spot	F	Nimble	F	Skyline	G	Vintage	H
Bambu-Envi	F	Curves Ahead	G	Hourglass	G	Nishiki	C	Sleek	D	Vision	C
Banyan	F	Cyma	H	Hudson	G	Nova	E	Sleeping Bear Dunes	F	Voltage	H
Bari	F	Daddy-O w/Agion	G	Hush	F	Now & Zen w/Agion	I	Smile	G	Volterra-Hc	H
Bass Line	G	Dakota	D	I Spy	H	Olympus	F	Smoothie	C	Vortexia	I
Beatbox	F	Dart	C	Impression	H	On The Money	F	Snuggle	E	Walk the Line	J
Beep Beep	G	Dash	D	Inside Track	D	Orbit	D	Solitaire	D	Whirl	G
Bespoke	E	Deflection	G	Interplay	F	Oscillate	I	Spark	J	Whisper	C
Bistro	C	Delphi	F	Interval	E	Outlander	D	Sphere	E	Whitney	F
Blip	C	Detail	G	Isabella	H	Oxford	C	Spindles	H	Willow Talk	H
Block Party	F	Deza	I	Jala	I	Pacifica	G	Spirit Millennium	C	Wink w/Agion	F
Bon Voyage	J	Diffusion	I	Jam Session w/Agion	I	Panorama	J	Splash	F	Wish	I
Bongo	H	Diva	D	Jambi Stripe	G	Park Avenue	F	Sprint	C	Wyatt	D
Breton	G	Dodgeball	G	Jasmine Screen	F	Patriot Plus II	C	Squire	E	Ybor	F
Brilliant	D	Double Time w/Agion	I	Jump w/Agion	I	Peninsula Mohair	I	Stat-Con	E	Ziggy	C
Bryant Park	C	Duet	E	Juxy	F	Perimeter	D	Stellar	D	Zodiac	D
Bubblerake	G	Dynasty	C	Kambala	I	Persuasion	E	Sterling w/Agion	F	Zoom	E
Budget Black	A	E'lan-HC	H	Kennebunk	F	Petals	G	Stipple	D		
Burkshire	C	Effervescense	F	Ketana	H	Pivot	C	Stitch In Time	D		
Calibration	F	Elderberry	G	Kilkenny Tweed	C	Polka	E	Straight and Narrow	G		
Calla	G	Eli	F	Kinetic	F	Portico	F	Strand	C		
Camino	H	English Pub	C	Knock Knock	I	Posh	E	Stratford	I		
Cannon Beach	H	Entrada	G	Kusari	D	Prisma	F	Sumatran Palm	H		
Canterbury	G	Equinox	F	Labyrinth	G	Profile	E	Summit	E		
Capreni	F	Excursion	E	Laredo	C	Promenade	E	Sunburst	G		
Carlisle	D	Expressions	C	Latitude	D	Queue	F	Sundance	E		
Casablanca	I	Facet	D	Lava	H	Radiance	H	w/Stakleen			
Cassidy	C	Fast Lane	D	Leaps & Bounds	F	Raffia	E	Sunswept	I		
Catalina	F	Fenestra	H	Lift	G	Rainier	C	Supersillyness	I		
Catalyst	C	Figment	H	Lindley Park	D	Rally	B	Swivel	G		
Catwalk	F	Finite	E	Line Dance	F	Raquette	G	Symmetry	H		
Celeste	J	Firefly	G	Links	G	Realm	E	Symphony Classic	C		
Chakra	H	Fizz	E	Linus	F	Refraction	C	Tender	H		



Ultrafabrics Fabric Grading

For memo samples at Ultrafabrics email charlotteakirby@yahoo.com

Grades and availability of fabric are subject to change without notice. Changes could include but are not limited to price increases, discontinued patterns, discontinued colors, etc. See jsifurniture.com for updated information.

<u>Pattern</u>	<u>Grade</u>
Brisa	E
Brisa Distressed	E
Brisa Fresco	E
Buffalina	E
Eco Tech	E
Hammered	E
Metro Tech	E
Patine	E
Raffia	E
Ultraleather	E
Ultraleather Fusion	E
Ultraleather Fusion Shimmer	E
Ultraleather Linen	E
Ultraleather Pearlized	E
Ultraleather Pony	E
Ultraleather Pro	F
Ultraleather Promessa	E
Ultraleather Uccello	E
Ultratech	E
Viva	E

Effective January 1, 2016 ▲

Wollsdorf Leather Grading

For memo samples call Wollsdorf at 336-884-5005

Grades and availability of leather are subject to change without notice. Changes could include but are not limited to price increases, discontinued patterns, discontinued colors, etc. See jsifurniture.com for updated information.

<u>Pattern</u>	<u>Grade</u>
Alpine	L2
Atlantic	L2
Euroglazed	L2
Finesse	L2
FOC Earth Black	L2
FOC Earth Colors	L2
Genoa	L2
Mammut	L1
Oslo	L2
Paloma	L2
Prima	L2
Pull Up	L2
Sattel	L2
Sedona	L2

Specification Tools

JSI products are manufactured to order and provide a multitude of options to address your individual customer needs. As you process your order do not forget to include all the necessary information to allow the order entry process to be completed. Please see the order checklist at the beginning of every series.

JSI Customer Service edits every order for complete information. If details are not included with the purchase order, Customer Service will contact you to answer these questions. If information is not completed in a timely manner it will delay the entry process and could effect your product delivery date. To avoid delay in order entry and potential delay in delivery of your order, please double check the line items to ensure all selections have been completed.

To ensure completion of details on your purchase order, electronic catalogs and specification tools have been developed to aid in the process. These electronic tools include:

20-20 GIZA Studio and 20-20 CAP Studio software offers state-of-the-art design, specification, photo-realistic rendering and three-dimensional visualization capabilities for configurable products in the commercial interior design markets. 20-20 GIZA Studio and 20-20 CAP Studio are available for all JSI Casegood and Seating products, in 2D and 3D graphics and the Specifier Catalog. Updates are made monthly reflecting any changes that occurred. To be sure the most up to date information is provided on orders, users of this software program are responsible to update their catalogs.

ProjectMatrix, Inc. offers a full software solution for the contract furniture industry. Their software can help you create space plans to specifications for ease of specifying our JSI Casegood and Seating product lines. Updates are made monthly reflecting any changes that occurred. To be sure the most up to date information is provided on orders, users of this software program are responsible to update their catalogs.

GSAdvantage is a Federal Government electronic catalog site offered to assist GSA customers in specifying and pricing JSI product. Listed at this site are all contract items and prices under GSA Contract # GS-28F-0030U.

Our JSI website jsifurniture.com provides many tools to assist in the design and order selection. Included in the site are downloadable images, typicals, product symbols, brochures, contact information, price lists, sales representative locations, warranty and environmental information.

GSA Terms and Conditions



Contract Holder

Contract # GS-28F-0030U

In addition to the standard terms and conditions, the following terms and conditions apply to GSA contract.

Contract Number

GS-28F-0030U

Contract Period

September 23, 1999 - June 24, 2018

Statement of Intended Use

The furniture covered by special item numbers 711-8, 711-9, 711-11, 711-16, 711-17, 711-18, 711-19, and 711-95 is intended for use by Government executives (or equivalent military rank) in the executive, judicial, and legislative branches or armed forces of the federal government. To help customers make a good purchasing decision based on their needs and budget, GSA has established four grades of furniture: Grade (1) includes furniture that tends to be the most expensive on this schedule, Grade (2) furniture tends to be more moderately priced and Grades (3) and (4) furniture tend to be affordable pricing when compared to grades (1) and (2). The ordering agency or service is responsible for determining furniture appropriate for use in its offices which will fit within budget and comply with applicable federal or internal agency procurement regulations.

Description of Special Item Numbers SIN#

711-8	Executive office furniture
711-9	Executive conference room furniture
711-11	Tables, occasional and conference
711-16	Upholstered seating
711-17	Multiple seating
711-18	Multi purpose seating
711-19	Stacking chairs and dollies
711-95	Installation services (not to exceed 12% of net prices for projects where installation costs are \$500 or less.) Installation costs over \$500 are negotiated on a case by case basis.

Maximum Order

711-8	\$500,000 (five hundred thousand dollars) net
711-9	\$500,000 (five hundred thousand dollars) net
711-11	\$500,000 (five hundred thousand dollars) net
711-16	\$300,000 (three hundred thousand dollars) net
711-17	\$200,000 (two hundred thousand dollars) net
711-18	\$200,000 (two hundred thousand dollars) net
711-19	\$200,000 (two hundred thousand dollars) net
711-95	\$150,000 (one hundred fifty thousand dollars) net

Minimum Order

\$100 (One hundred dollars) net

Geographic Coverage

48 contiguous states and Washington D.C.

Business Size

Large Business

Point of Production

Ferdinand, Dubois County, Indiana
 French Lick, Orange County, Indiana
 Jasper, Dubois County, Indiana
 Paoli, Orange County, Indiana

Pricing

All prices shown are list prices (freight included)

Discount

Discount 61.6%* off list.

*Discount for CaseWorks, Reflections, Walden and Wellington is 61.71% off list.

Quantity Discounts

Not applicable.

Prompt Payment Terms

1% 15 - net 30 days from date of invoice.

Government Commercial Credit Cards

Accepted. No additional discount offered.

Foreign Terms

Not applicable.

Delivery Time

30-75 days after receipt of order, 90 days maximum.

Overnight and 2-day Delivery

Not applicable.

Urgent Requirements

Contact Customer Service if faster delivery is required.

F.O.B. Points

F.O.B. destination, freight prepaid and allowed to 48 contiguous states and Washington D.C. excludes special delivery requirements.

Ordering Address

JSI
 Attn: Participating Dealer
 225 Clay Street
 Jasper, IN 47546
 Fax: 812-482-1548
 Phone: 800-457-4511
 Email: orders@jaspergroup.us.com

Product Modifications

We willingly accept customers' modifications to standard products. See product modifications information by series at the start of each series under the "Product Modification" sections. If there is a modification you desire that is not listed in this section, please call Customer Service for a modification quote/price.

GSA Terms and Conditions

Payment Address

JSI
225 Clay Street
Jasper, IN 47546

Warranty Provision

JSI's commercial 15 year warranty applies. See page 3.[▲]

Export Package Charges

Quoted on project-by-project basis.

Terms of Government Commercial Credit Card Acceptance

Accepted.

Rental, Maintenance, and Repair

Not applicable.

Installation

Contact dealer or installation representative.

Repair Parts

Not applicable.

Service and Distribution Points

National distribution.

Participating Dealers

Contact JSI customer service at 800-457-4511.

Preventive Maintenance

Not applicable.

Environmental Attributes

JSI is committed to protecting the environment. For JSI's complete environmental information, contact the GSA Customer Service at 800-457-4511. Go to jsifurniture.com for additional information.

Duns

00-636-7767

Notification Regarding Registration in SAMS Database

Name: Jasper Seating Company, Inc.

Cage code: 31881

Acceptance, Modification, Assignment

By placing this order for furniture, material or other products (sometimes collectively referred to as "goods"), customer agrees to these terms and conditions which shall prevail over inconsistent provisions in any other form or document of customer. No change or modification shall be applicable unless set forth in writing and signed by company. Neither this order nor any interest therein shall be assigned by customer except with the prior written consent of company.

Payment

Customer agrees to pay to company the amount indicated on the invoice, 1% 15 days, net 30 days from date of invoice (U.S. funds only), for goods ordered. Interest will be charged after 30 days from the date of invoice at the rate of one and a half percent (1.5%) per month. International sales will require additional payment arrangements. No goods shall be sold on consignment or conditional sales basis. Payment for the goods delivered hereunder shall constitute acceptance thereof.

Attorneys' Fees

Customer shall be responsible for all expenses and cost in connection with the enforcement by company of these terms and conditions and the cost of collection (including the fees of any collection agencies to whom the customer's account may be referred), plus reasonable attorneys' fees (which attorneys' fees shall not be less than 25% of the amount due, unless a lower amount is specified by applicable law).

Remedies

The remedies herein reserved shall be cumulative, and additional to any other or further remedies provided in law or equity. No waiver of a breach of any provision of these terms and conditions shall constitute waiver of any other breach or of such provision.

Insolvency

Company may forthwith cancel this order in the event of the happening of any of the following or any other comparable event: insolvency of the customer, the filing of a voluntary petition in bankruptcy, the filing of any involuntary petition to have customer declared bankrupt provided it is not vacated within thirty (30) days from the date of filing, the appointment of a receiver or trustee for customer provided such appointment is not vacated within thirty (30) days from the date of such appointment, or the execution by customer of an assignment for the benefit of creditors.

Limitation of Liability

The Company shall not under any circumstances be liable to the customer, owner of the goods or any third party for special, indirect, incidental, or consequential damages, including, without limitation, loss of profits or revenues, loss or damage to other property or equipment, cost of capital or of purchased or replacement goods, or expense, delay, or inconvenience cause by or arising from the purchase, sale, use, repair or inability to use the goods or by any performance or non-performance under, or breach of, these terms and conditions. The Company's sole liability for any defective goods shall be its repair or its replacement pursuant to the express warranties set forth above, or if amended, as applicable at the time of manufacture or repair of the goods. Some states do not allow the exclusion or limitation of incidental or consequential damages, so the above limitations or exclusion may not apply to all customers. Any action resulting from any breach on the part of company as to the goods or services delivered here under must be commenced within one year after the cause of action has occurred.

Returns and Allowances

Reasonable touch-up and deluxing is the dealer's responsibility. The Company will not make allowances for trip or delivery charges, but will only make allowance for actual work performed to correct manufacturing defects. Allowances maybe authorized only by a company officer. It is the responsibility of the field sales representative to inspect any defective merchandise and make suggestions and recommendations as to the proper disposition. Field personnel cannot obligate or bind the company by definite agreement, without final authorization by a company officer. Company will not accept automatic charge backs which do not have prior authorization. All defects must be called to the company's attention upon arrival at the customer's "ship to" destination. To initiate any type of claim or request for parts, it is imperative to have the model number or fabric number, which may be located on the tag attached to the frame of the unit. Authorization for return to the company via a return goods authorization. Company will not issue credit allowances for any repairs without company's prior consent. Under no circumstances shall the company accept COD (cash on delivery) returns, and any such shipment will be refused.

GSA Terms and Conditions

Security Agreement

The Company may require and customer shall grant a security interest in goods sold pursuant to any credit the company may extend to the customer.

Governing Law

All disputes between the parties, whether or not arising out of these terms and conditions, will be governed by the laws of the state of Indiana. Customer agrees to submit to the jurisdiction of and agrees all lawsuits relating to any disputes between the customer and the company will be brought only in a state court located in Dubois County, Indiana or the United States District Court for the Southern District of Indiana. The customer hereby waives the right to a trial by jury in any action, proceeding, claim, or counterclaim whether in contract or tort, at law or in equity, arising out of or relating in any way to these terms and conditions and all other disputes between the parties.

Mitigation

If the company repossesses the goods prior to payment by the customer of all amounts due hereunder, the company may sell the goods, as is, where is, free and clear of all rights of the customer at either public or private sales, and apply the net proceeds (after deducting expenses of repossession and sale) to the obligation of customer hereunder. The customer may dispose of the goods in any commercially reasonable place and manner and the customer waives any notice of time, place and manner of sale.

Integration

This order for goods, including these terms and conditions, along with any credit application, invoice, statement, dealer contract, acknowledgment, bill of lading (and any exhibits, addenda or amendments thereto) of which this order may be a part, constitutes the sole and complete agreement between the company and the customer with respect to the purchase of the goods.

Dimensions/Specifications/Finishes

All dimensions are approximate and may vary due to the upholstery technique of each craftsman. If exact dimensions are required, it is necessary for the customer to state such specifications with the order. Detailed specifications sheets are available for each series of goods, and customer should consult the company's customer service department for these specification sheets. Company reserves the right to make changes in dimensions, style, or specifications if company believes these changes will improve the goods' quality or appearance. Company reserves the right to substitute hardwoods due to availability at production. Due to the natural characteristics of wood, environmental effects, and material upgrades, the company cannot guarantee exact finish matches on existing goods previously ordered from company. If an exact match to customer's existing goods is required, it must be specified so that the proper procedures can be followed to ensure an acceptable finish. Company will accept no liability for the finish if this procedure isn't followed. Company reserves the right to make changes in a finish formula if company believes the change will improve the quality or appearance of company's goods.

Company's Performance of Its Obligation

The production and delivery of the goods to the extent delayed or hindered or prevented from the performance by reason of natural disasters, acts of god, strikes, lockouts, labor troubles, inability to procure materials, casualties, failure of power, restrictive governmental laws or regulations, riots, insurrections, acts of terrorism, war or other reason of a like nature not the fault of the company shall excuse for the period of the delay the company's performance and the period for the performance shall be extended for a period equivalent to the period of such delay.

Contemporary / Transitional - Conference & Meeting Room Product





APOGEE™

Apogee™ Product Information

Wood Materials

Exterior surfaces are made from the finest selected veneers. Matching solid lumber wood species are used to coordinate with the veneer. High quality MDF is used on the painted surfaces.

Apogee™ is available in quarter cut Walnut, quarter cut Maple, quarter cut Makore or Double Cut veneer.

Exterior Metal Materials

A custom shaped extruded anodized aluminum pull is used on the drawers and doors. The thin profile glass door frame is also anodized aluminum, along with the valance rail used with task lights on overheads.

Leg and Post frames are fabricated steel tubing finished with a Bright White or Arctic Silver powder coat. Shelf dividers, wire dividers, and other metal trims are fabricated and finished in a matching Silver powder coat.

Metal Finishes

ASL Arctic Silver BWH Bright White

Worksurface Construction

All tops are 1 3/16" thick with 3-ply construction and trimmed off with matching 1.5mm rims. Worksurface tops are only available in the Apogee™ veneer options. Requests for laminated tops will need to be reviewed for approval, contact Customer Service.

Case Construction

All cases are constructed with mortise, tenon, and dowels. Interior cases are reinforced with glued cleats and screws. Panels for cases are normally 3/4" thick with 3-ply construction. All pedestals have enclosed bottoms.

Plinth style bases are attached directly to the bottom of the cases. The metal glide housing inside the base provides for accurate leveling. Front and back glides in drawer pedestals can be adjusted up and down by removing the lower drawer and using the glide access hole located in the bottom of the case.

Cabinet doors have 110° swing hinges to allow adequate access into cabinets. Hinges are fitted with a soft close device, requiring only a soft push to close the door. Units taller than 18" are fitted with an adjustable shelf.

Drawer Construction

Drawers are assembled using a four corner dovetail box and 3/4" thick drawer bottom panel construction. The exterior front is attached separately. Sides and backs are approximately 1/2" thick solid hardwood. Drawer components have a UV finish to protect against shrinking, swelling, or warping and to provide a clean smooth feel and appearance. Lateral files have reinforced bottoms.

The exterior front panel is 3-ply and 3/4" thick. The front is attached to the assembled drawer box. The anodized aluminum pull runs along the top or bottom edge of the drawer front.

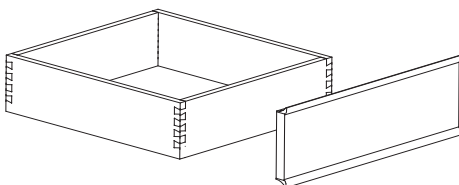

box drawer and front with pulls (middle drawer)
wood drawer box - DRW

Drawer Suspensions

Suspensions are black and carry a lifetime warranty. File and Box drawers have 100% full extension with over travel. Slides feature steel ball bearings for longer wear. Suspensions on utility, box and file drawers have a soft close device, allowing for an effortless closing of the drawer.

Filing Systems

All drawers intended for filing come with clips and metal stretchers to accommodate hanging folders.

Finish - Stain/Colors

We offer a variety of wood stains and paint colors on Apogee™. Please see the chart below. Samples are available upon request. Former finish names are listed in parentheses for reference.

MK2 Makore *Quarter Cut Veneer*

AUT Autumn (<i>Autumn Cherry</i>)	EAR Earthy
BRL Barley	LGC Legacy (<i>Legacy Cherry</i>)
BBN Bourbon (<i>Natural Cherry</i>)	PRL Praline (<i>Vintage Cherry</i>)
BRG Brighton (<i>Brighton Cherry</i>)	SAF Saffron (<i>Medium Cherry</i>)
CLA Classic (<i>Classic Cherry</i>)	

MA2 Maple *Quarter Cut Veneer*

ALE Ale (<i>Natural Maple</i>)	FLX Flax
BUT Butterscotch	VEN Venetian (<i>Dark Mahogany</i>)
CIN Cinnamon	

WA2 Walnut *Quarter Cut Veneer*

AUB Auburn (<i>Windsor Mahogany</i>)	SIE Sienna
ESP Espresso	TOF Toffee
MCH Mocha	TRF Truffle
NTO Night Owl (<i>Vintage Walnut</i>)	

DC1 Double Cut Veneer

COF Coffee	KHK Khaki
CRM Cremello	STU Studio Teak
GRH Graphite	

PNT Paint *MDF Board*

BKD Backdrop	GRV Greek Villa
BFX Black Fox	NET Network Gray
BWH Bright White	NWH Nonchalant White
CGP Cargo Pants	STM Storm
CHT Chatroom	TRC Tricorn Black
FRR French Roast	

Protective Top Coat

DuraTex™ offers exceptional hardness along with abrasion and impact resistance, it has been formulated to eliminate hazardous and harmful gases that are normally associated with wood finish.

DuraTex™ Features

Safety - Significantly reduces hazardous formaldehyde emissions which help improve the quality of the indoor air we breathe. **Quality** - Developed to be tough and durable with special attention to appearance. The DuraTex™ finish preserves the natural beauty of wood. **Durability** - Designed to meet a wide range of demanding performance and environmental standards to withstand even the highest wear and tear.

Apogee™ Product Information

Product Modification

Laminate Tops

Work surface only, no additional upcharge if coordinating wood grain laminate is specified. Contact Customer Service for any other laminate request.

Cherry Finishes	Maple Finishes	Walnut Finishes
<i>Autumn</i>	<i>Ale</i>	<i>Auburn</i>
<i>Barley</i>	<i>Cinnamon</i>	<i>Mocha</i>
<i>Bourbon</i>	<i>Venetian</i>	<i>Night Owl</i>
<i>Brighton</i>		<i>Sienna</i>
<i>Classic</i>		<i>Toffee</i>
<i>Legacy</i>		<i>Truffle</i>
<i>Praline</i>		
<i>Saffron</i>		

Special Finishes

Special finishes can be requested by following the instructions in the general introduction section, page 3. There is a one time charge of \$289 list per order.

Special Top Sizes and Cabinets

Apogee offers a large offering of products to create a perfect meeting room. Contact Customer Service if you are having trouble finding the right units to complete the desired configuration. Special sizes and cabinet variations need to be approved by JSI engineering.

Apogee™ Product Information

Quarter Cut Veneer Grain Direction

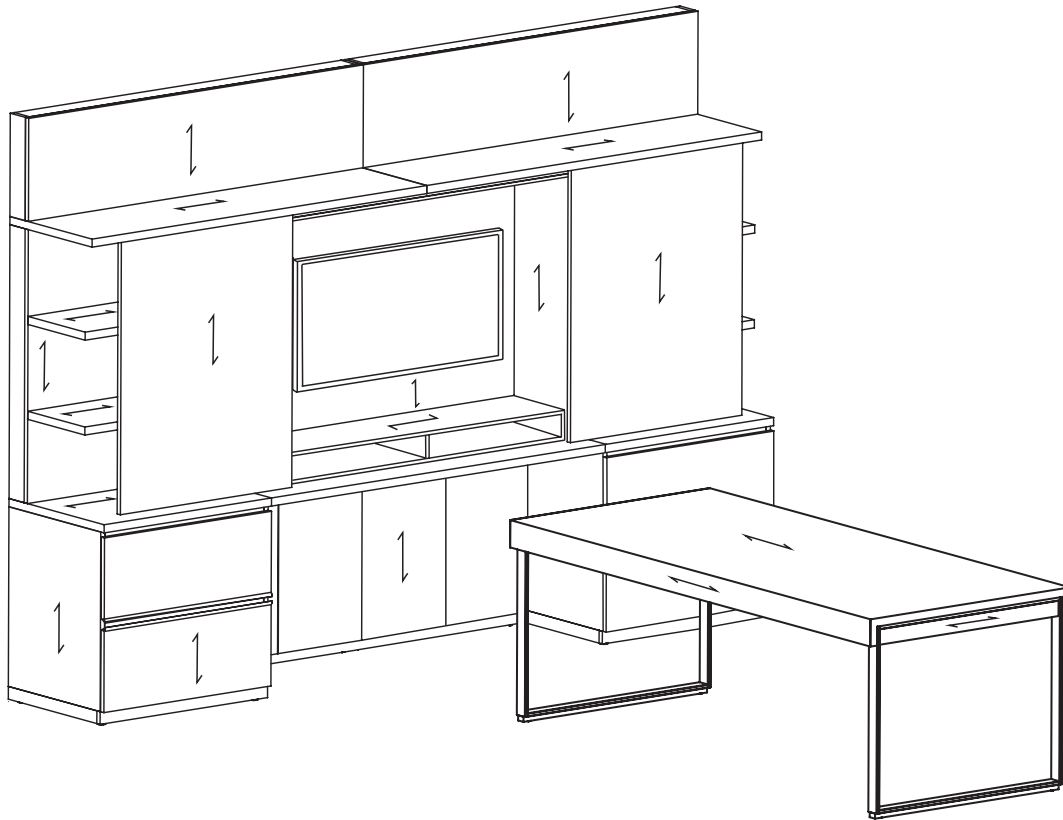

APOGEE™

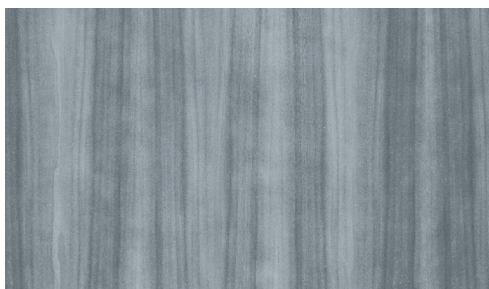

Quarter Cut Veneer

Standard direction for quarter cut veneer on Apogee™ is vertical.

The log is cut into quarters prior to slicing. This method bisects annual growth rings and results in a straight grain or ribbon-striped appearance.

Apogee™ Product Information

Double Cut Veneer Grain Direction

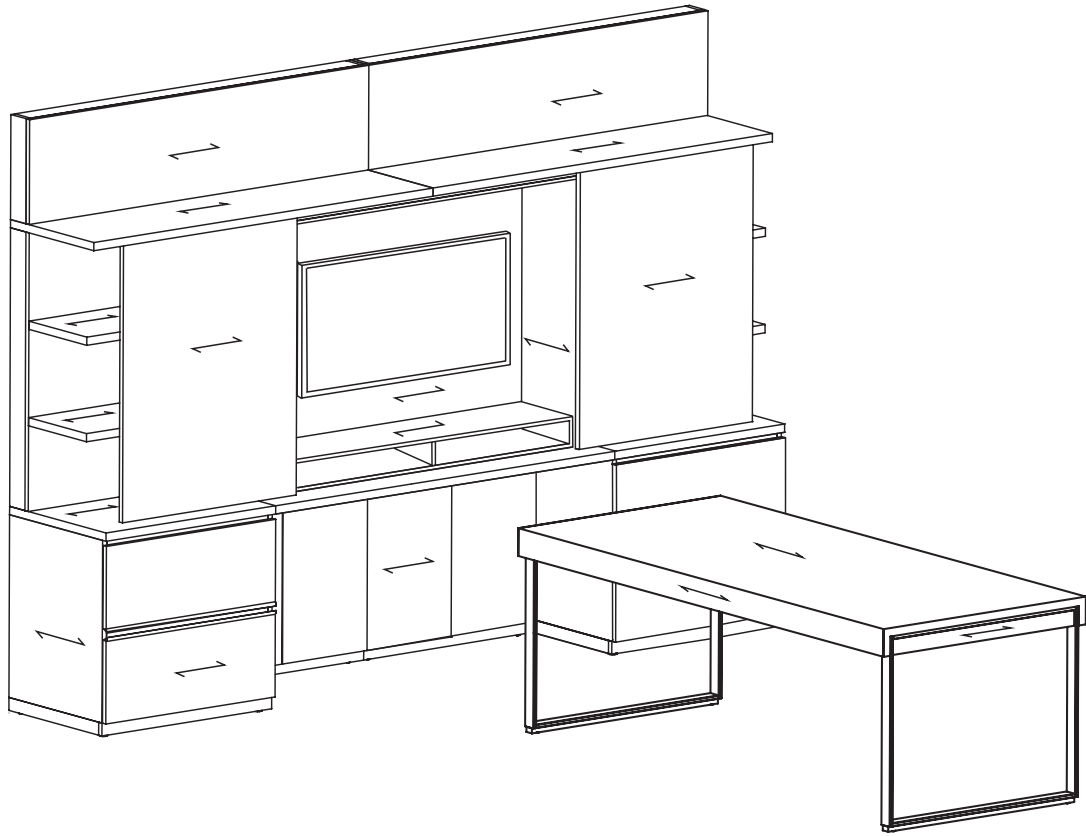

APOGEE™



Double Cut Veneer

Standard direction for double cut veneer on Apogee™ is horizontal.

This veneer uses multiple layers of thin wood which is re-assembled, then re-cut in a factory, under controlled specifications. The veneer used in our program is a uniform straight grain pattern and is pre-stained for color consistency.

Apogee™ Product Information

Corner Profiles and Grommet

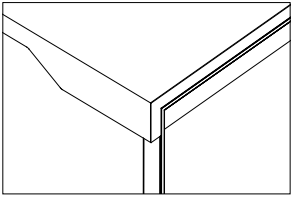

corner of an open frame end table

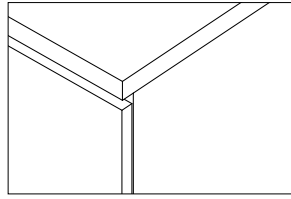

front corner of a credenza top

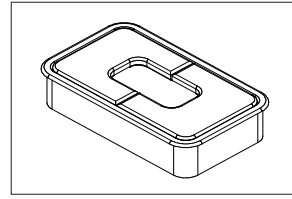

standard worksurface grommet

Base Details

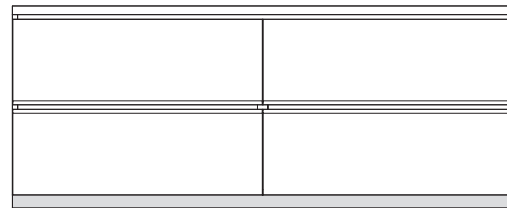
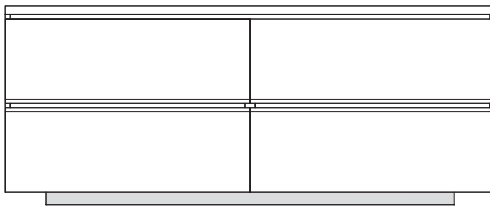
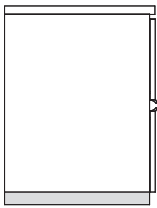

Stand alone laterals and credenzas are available with either a 6" inset base or a flush base; all have a 3/4" inset on the front base.

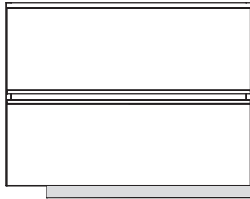
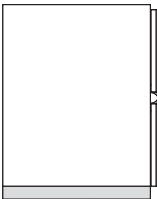

+

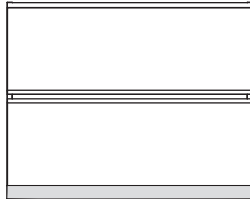

+

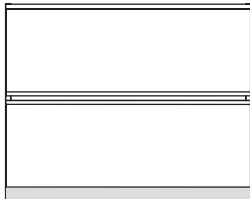
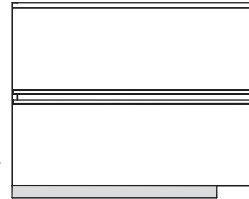

+

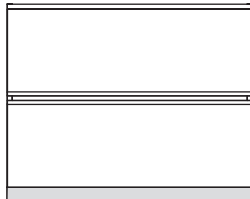

+

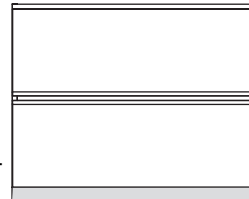

Modular units, storage cabinets, and wardrobes with bases are available with left inset, flush, or right inset.

Inset bases on the sides are 6", all have the front inset 3/4".

*** Specify the correct models to create the desired aesthetics.

Apogee™ Product Information

Workwall Components

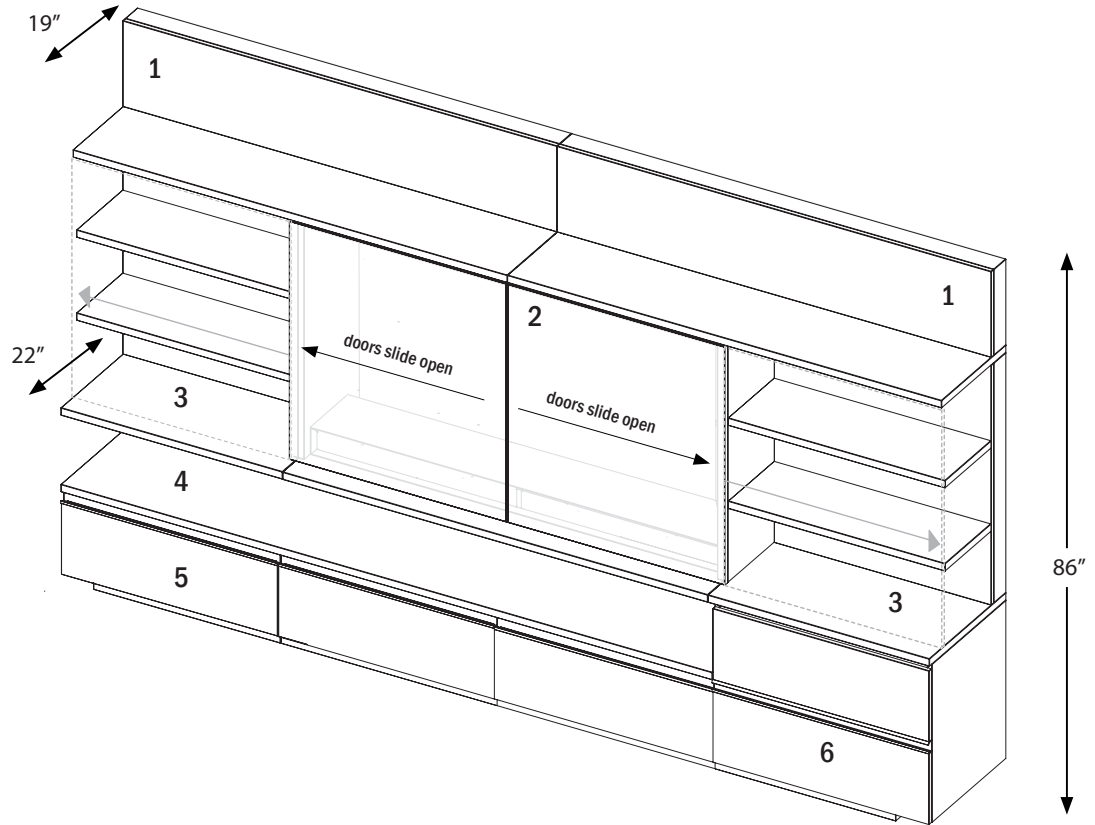

Workwalls can be specified with Open Shelves or Workwall with Work Centers solutions

One height & one depth of workwall
 Left and Right End Section specified as a set
 Tops are included with each section of workwalls components

1 Sections of Workwall

Doors available in veneer finish, paint, or back painted glass with or without magnetic feature. Wall attachment required.

2 Workcenter

Five different configurations: shown monitor center, refer to casegood volume 1, price book for additional configurations.

3 Tops (included with Workwall components)

4 Partial Wall Access Panel

Tops included with some units.

5 Low Storage: One-High Lateral File

6 Low Storage: Two-High Lateral File

Additional Layouts

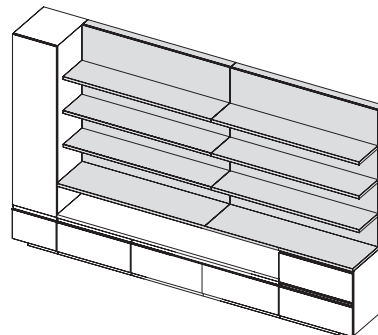
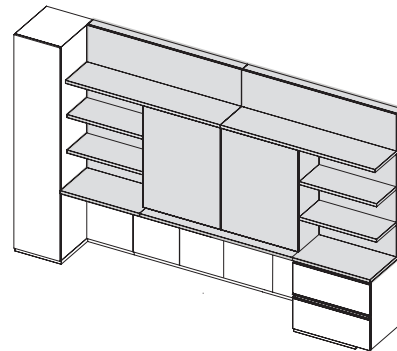

Apogee™ Product Information

- 1 Select an overall layout style.
Consider the overall width, Workwalls are available in 144" or 120" widths.
- 2 Choose the workwall, either full open shelves or units with an open center section and doors. When choosing the units with doors you must also select a workcenter, this is required and is specified as a separate model.

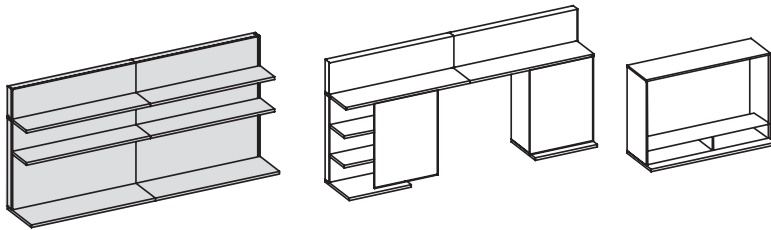

- 3 If using one-high storage/lateral, select the correct kneespace access unit.
If side units such as wardrobe cabinets flank the workwall use the unit without the built in support extensions.

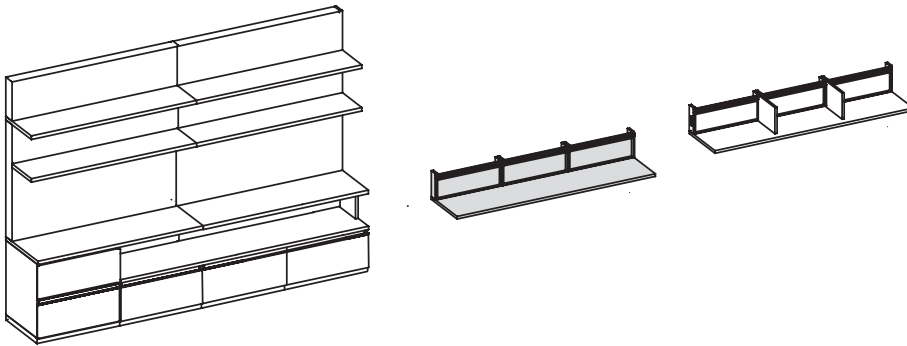

Note: These units are only needed when NOT using a workwall and without adjacent storage support

- 4 Choose the lower units to complete the workwall.

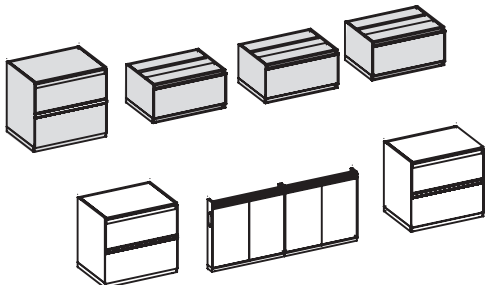

Apogee™ Product Information

Finish & Paint Scheme

(see page 28 for list finish options)

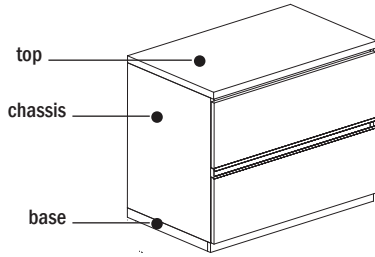

- tops** - veneer only
- chassis/drawer fronts** - veneer or paint
- base** - must match either top or chassis

can only choose one veneer finish and one paint per unit

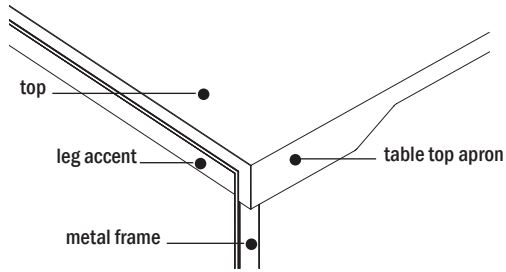

- top and table top apron** - veneer only
- leg accent** - veneer or paint
- metal frame** - arctic silver or bright white

can only choose one veneer finish and one paint per unit

Apogee™ Product Information

Finish and Product Reference Codes

APOGEE™

Select	Code
--------	------

Veneer	
Makore Quarter Cut	MK2
Maple Quarter Cut	MA2
Walnut Quarter Cut	WA2
Double Cut	DC1

Select	Code
--------	------

Finish	
Cherry/Makore Finishes	
Autumn	AUT
Barley	BRL
Bourbon	BBN
Brighton	BRG
Classic	CLA
Earthy	EAR
Legacy	LGC
Praline	PRL
Saffron	SAF
Maple Finishes	
Ale	ALE
Butterscotch	BUT
Cinnamon	CIN
Flax	FLX
Venetian	VEN

Select	Code
--------	------

Walnut Finishes	
Auburn	AUB
Espresso	ESP
Mocha	MCH
Night Owl	NTO
Sienna	SIE
Toffee	TOF
Truffle	TRF
Double Cut Finishes	
Coffee	COF
Cremello	CRM
Graphite	GRH
Khaki	KHK
Paint Finishes	
Backdrop	BKD
Black Fox	BFX
Bright White	BWH
Cargo Pants	CGP
Chatroom	CHT
French Roast	FRR
Greek Villa	GRV
Network Gray	NET
Nonchalant White	NWH
Storm	STM
TRC	TRC

Select	Code
--------	------

Laminate Coordinates	
Cherry Wood Grain Patterns	
Autumn	AUT
Barley	BRL
Bourbon	BBN
Brighton	BRG
Classic	CLA
Legacy	LGC
Praline	PRL
Saffron	SAF
Maple Wood Grain Patterns	
Ale	ALE
Cinnamon	CIN
Venetian	VEN
Walnut Wood Grain Patterns	
Auburn	AUB
Mocha	MCH
Night Owl	NTO
Sienna	SIE
Toffee	TOF
Truffle	TRF
Metal Finish	
Arctic Silver	
Anodized Aluminum	

Order Check List:

Specify:

- 1. Model Number
- 2. Finish Scheme/Color (see page 35)
- 3. Wood Species - cherry - makore - maple - walnut - double cut
- 4. Top Options - standard veneer - laminate surface - back painted white glass (shiny)
- 5. Other Product Options
- 6. Power and Data Accessories (*drawing showing location and orientation must accompany order*)
- 7. Side Mark Information (*i.e. room number, East Conference Room*)
- 8. Shipping Address (*contact name and phone number*)
- 9. Special Delivery Instructions (*i.e. call before delivery, deliver to job site*)

Description	D	W	H	CTN WT	CU FT	① Model	List Price
Meeting Table	36	84	29½	174	61	AP8-MTL-1-3684	\$2,468

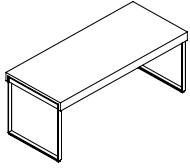

- veneer top with veneer wrapped apron
- straight apron both sides
- top long grain veneer direction
- grommet available, specify and add \$79 list each
- kneespace height: 25½"
- kneespace width between legs: 80"

APOGEE™

Description	D	W	H	CTN WT	CU FT	① Model	List Price
Storage Credenza with Flush Base	22	72	29 ½	347	33	AP2-HPD-1-2272	\$4,594
	22	60	29 ½	303	28	AP2-HPD-1-2260	\$4,489

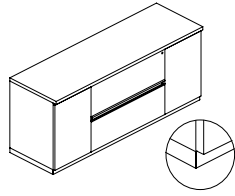

- base is flush
- top long grain veneer direction
- pedestal front locking
- locking doors available, specify and add \$210 list
- soft close hinge doors
- door top has concealed bevel for opening
- adjustable levelers/glides
- grommet available, specify and add \$79 list each; see page 45
- -2272 two hinged door compartments with adjustable shelf, 18" w
- -2272 two 36" w lateral files
- -2260 two hinged door compartments with adjustable shelf, 15" w
- -2260 two 30" w lateral files

Storage Credenza with Inset Base	22	72	29 ½	340	33	AP2-HPD-B-2272	\$4,594
	22	60	29 ½	297	28	AP2-HPD-B-2260	\$4,489

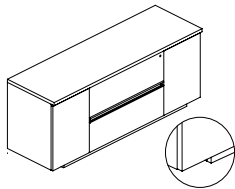

- base is inset on both sides
- top long grain veneer direction
- pedestal front locking
- locking doors available, specify and add \$210 list
- soft close hinge doors
- door top has concealed bevel for opening
- adjustable levelers/glides
- grommet available, specify and add \$79 list each
- -2272 two hinged door compartments with adjustable shelf, 18" w
- -2272 two 36" w lateral files
- -2260 two hinged door compartments with adjustable shelf, 15" w
- -2260 two 30" w lateral files

To Order, Specify:

Meeting Table

- ① Model Number
- ② Wood Species on Top/Veneer Wrapped Apron - Makore (MK2), Maple (MA2), Walnut (WA2) or Double Cut (DC1) (see page 36)
- ③ Finish Color for Top/Veneer Wrapped Apron (see page 36)
- ④ Leg Accent Finish
 - A.. Same as Top
 - B. Paint (see page 36)
- ⑤ Metal Open Frame Color (see page 36)

Note: Only one wood finish and one paint color can be specified per unit

Credenzas

- ① Model Number
- ② Wood Species on Top - Makore (MK2), Maple (MA2) Walnut (WA2) or Double Cut (DC1) (see page 36)
- ③ Finish Color for Top (see page 36)
- ④ Finish Color for Chassis/Drawer Fronts
 - A. Same as Top
 - B. Paint (see page 36)
- ⑤ Finish Color for Base
 - A. Same as Top
 - B. Same as Chassis/Drawer Fronts or Paint (see page 36)

Note: Only one wood finish and one paint color can be specified per unit

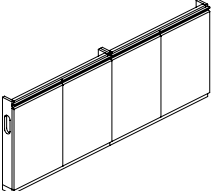
Description	D	W	H	CTN WT	CU FT	① Model	List Price
Kneespace Access Panel, Full Height 	4	72	28 ³ / ₈	80	8	AM7-PAP-1-0472	\$1,985
	4	66	28 ³ / ₈	74	7	AM7-PAP-1-0466	\$1,827
	4	60	28 ³ / ₈	69	7	AM7-PAP-1-0460	\$1,670
	4	54	28 ³ / ₈	64	6	AM7-PAP-1-0454	\$1,565
	4	48	28 ³ / ₈	58	5	AM7-PAP-1-0448	\$1,460
	4	42	28 ³ / ₈	46	5	AM7-PAP-1-0442	\$1,355
	4	36	28 ³ / ₈	40	4	AM7-PAP-1-0436	\$1,250
	4	30	28 ³ / ₈	34	3	AM7-PAP-1-0430	\$1,145
	4	24	28 ³ / ₈	29	3	AM7-PAP-1-0424	\$1,040

- hinge doors
- wire pass thru to allow access to the next unit
- access for outlets 18"-24" AFF (Above Finished Floor)
- cantilever bracket included
- adjustable levelers/glides
- due to back construction unit is intended to sit against wall for wall access
- recommend wall attachment

End Support	22	6	28 ³ / ₈	49	3	AM7-CSP-1-2206	\$1,087
	15	6	28 ³ / ₈	34	2	AM7-CSP-1-1506	\$972

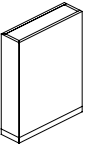

- use with modular components at the end of a run
- attachment bracket included
- non-handed, requires field boring for hardware
- adjustable levelers/glides

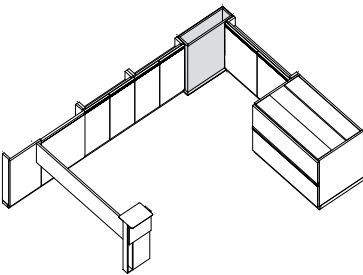

Description	D	W	H	CTN WT	CU FT	① Model	List Price
One-High Lateral File with Flush Base	22	72	15 ¾	205	19	AM7-FLA-1-2272	\$2,678
	22	60	15 ¾	170	16	AM7-FLA-1-2260	\$2,573

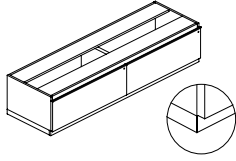

- without top
- base is flush
- pedestal front locking
- adjustable levelers/glides
- modular top required, see pages 43 and 44

One-High Lateral File with Inset Base	22	72	15 ¾	202	19	AM7-FLA-1R-2272R	\$2,678
	22	72	15 ¾	202	19	AM7-FLA-1L-2272L	\$2,678
	22	60	15 ¾	166	16	AM7-FLA-1R-2260R	\$2,573
	22	60	15 ¾	166	16	AM7-FLA-1L-2260L	\$2,573

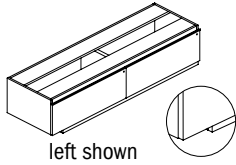

- without top
- base is inset on one side
- pedestal front locking
- adjustable levelers/glides
- modular top required, see pages 43 and 44

One-High Lateral File with Flush Base	22	36	15 ¾	105	10	AM7-FLA-1-2236	\$1,449
	22	30	15 ¾	87	8	AM7-FLA-1-2230	\$1,397

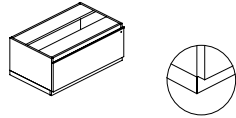

- without top
- base is flush
- pedestal front locking
- adjustable levelers/glides
- modular top required, see pages 43 and 44

One-High Lateral File with Inset Base	22	36	15 ¾	102	10	AM7-FLA-1R-2236R	\$1,449
	22	36	15 ¾	102	10	AM7-FLA-1L-2236L	\$1,449
	22	30	15 ¾	84	8	AM7-FLA-1R-2230R	\$1,397
	22	30	15 ¾	84	8	AM7-FLA-1L-2230L	\$1,397

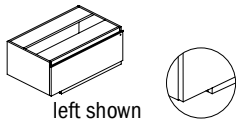

- without top
- base is inset on one side
- pedestal front locking
- adjustable levelers/glides
- modular top required, see pages 43 and 44

To Order, Specify:

- ① Model Number
- ② Wood Species/Paint on Chassis/Drawer Fronts -
Makore (MK2), Maple (MA2), Walnut (WA2),
Double Cut (DC1) or Paint (PNT)
(see page 36)
- ③ Finish Color for Chassis/Drawer Fronts
(see page 36)
- ④ Finish Color for Base
A. Same as Chassis/Drawer Front
B. Paint (see page 36)

Note: Only one wood finish and one paint color can be specified per unit

Description	D	W	H	CTN WT	CU FT	① Model	List Price
One-High Pedestal with Flush Base	22	18	15 ¾	62	5	AM7-PUA-1-2218	\$1,014

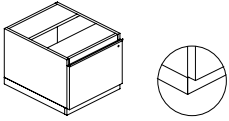

- without top
- base is flush
- soft close file drawer
- pedestal front locking
- adjustable levelers/glides
- modular top required, see pages 43 and 44

APOGEE™

One-High Pedestal with Inset Base	22	18	15 ¾	58	5	AM7-PUA-1R-2218R	\$1,014
	22	18	15 ¾	58	5	AM7-PUA-1L-2218L	\$1,014

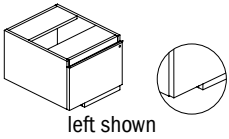

- without top
- base is inset on one side
- soft close file drawer
- pedestal front locking
- adjustable levelers/glides
- modular top required, see pages 43 and 44

note: not a stand alone unit

Description	D	W	H	CTN WT	CU FT	① Model	List Price
Kneespace Access Panel, Partial Height with Workwall Top	22	108	12 5/8	135	24	AM7-WTP-1-22108	\$3,350
	22	90	12 5/8	114	20	AM7-WTP-1-2290	\$3,171

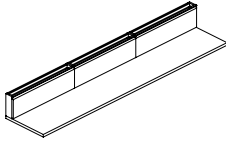

- use with one-high pedestals
- internal wire pass thru
- cantilever bracket included
- recommend wall attachment
- required access outlet 24" AFF (Above Finished Floor)

Kneespace Access Panel, Partial Height with Workwall Top	22	72	12 5/8	90	16	AM7-WTP-1-2272	\$2,604
	22	60	12 5/8	76	13	AM7-WTP-1-2260	\$2,426

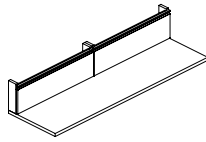

- use with one-high pedestals
- internal wire pass thru
- cantilever bracket included
- recommend wall attachment
- required access outlet 24" AFF (Above Finished Floor)

Kneespace Access Panel, Partial Height with Workwall Top	22	36	12 5/8	45	8	AM7-WTP-1-2236	\$1,544
	22	30	12 5/8	38	7	AM7-WTP-1-2230	\$1,428

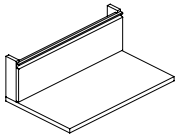

- use with one-high pedestals
- internal wire pass thru
- recommend wall attachment
- required access outlet 24" AFF (Above Finished Floor)

To Order, Specify:

Pedestal

- ① Model Number
- ② Wood Species/Paint on Chassis/Drawer Front - Makore (MK2), Maple (MA2), Walnut (WA2), Double Cut (DC1) or Paint (PNT) (see page 36)
- ③ Finish Color for Chassis/Drawer Fronts (see page 36)
- ④ Finish Color for Base
 - A. Same as Chassis/Drawer Front
 - B. Paint (see page 36)

Access Panel

- ① Model Number
- ② Wood Species on Top - Makore (MK2), Maple (MA2), Walnut (WA2) or Double Cut (DC1) (see page 36)
- ③ Finish Color for Top (see page 36)
- ④ Finish Color for Chassis/Door Front
 - A. Same as Top
 - B. Paint (see page 36)

Note: Only one wood finish and one paint color can be specified per unit

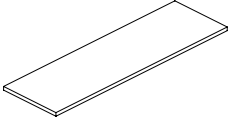
Description	D	W	H	CTN WT	CU FT	① Model	List Price
22" d Workwall Top 	22	120	1 7/8	89	7	AM7-WTU-1-22120	\$1,633
	22	114	1 7/8	85	7	AM7-WTU-1-22114	\$1,570
	22	108	1 7/8	80	6	AM7-WTU-1-22108	\$1,507
	22	102	1 7/8	76	6	AM7-WTU-1-22102	\$1,444
	22	96	1 7/8	71	6	AM7-WTU-1-2296	\$1,381
	22	90	1 7/8	67	5	AM7-WTU-1-2290	\$1,318
	22	84	1 7/8	62	5	AM7-WTU-1-2284	\$1,213
	22	78	1 7/8	58	5	AM7-WTU-1-2278	\$1,150
	22	72	1 7/8	53	4	AM7-WTU-1-2272	\$1,087
	22	66	1 7/8	49	4	AM7-WTU-1-2266	\$1,024
	22	60	1 7/8	45	4	AM7-WTU-1-2260	\$961
	22	54	1 7/8	40	3	AM7-WTU-1-2254	\$898
	22	48	1 7/8	36	3	AM7-WTU-1-2248	\$835
	22	42	1 7/8	32	3	AM7-WTU-1-2242	\$772
	22	36	1 7/8	27	2	AM7-WTU-1-2236	\$709
	22	30	1 7/8	23	2	AM7-WTU-1-2230	\$646

· long grain veneer direction

APOGEE™

Description	D	W	H	CTN WT	CU FT	① Model	List Price
Kneespace Access Panel, Partial Height	4	72	11 ½	33	4	AM7-PAS-1-0472	\$1,628
	4	60	11 ½	29	3	AM7-PAS-1-0460	\$1,449

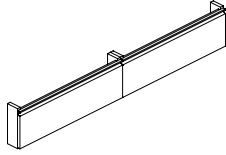

- use with one-high pedestals
- doors flip down for access to the wall
- internal wire pass thru
- cantilever bracket included
- recommended wall attachment
- access outlet 24" AFF (Above Finished Floor)

Kneespace Access Panel, Partial Height	4	36	11 ½	17	2	AM7-PAS-1-0436	\$1,092
	4	30	11 ½	15	2	AM7-PAS-1-0430	\$1,003
	4	18	11 ½	11	1	AM7-PAS-1-0418	\$914

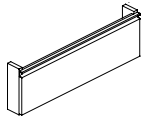

- use with one-high pedestals
- door flips down for access to the wall
- recommended wall attachment
- access outlet 24" AFF (Above Finished Floor)

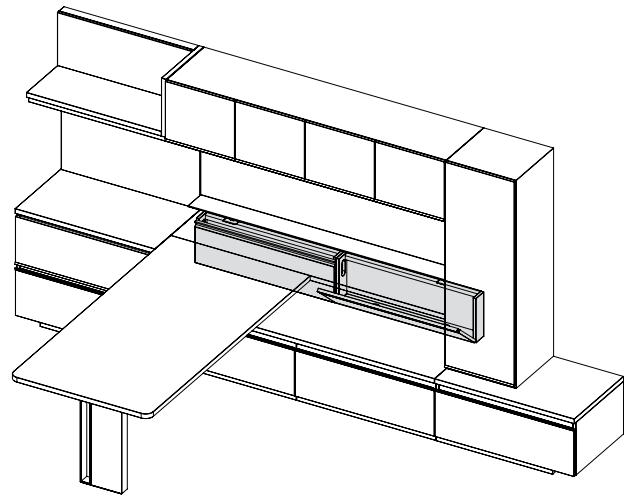

To Order, Specify:

Workwall Top

- ① Model Number
- ② Wood Species - Makore (MK2), Maple (MA2), Walnut (WA2) or Double Cut (DC1) (see page 36)
- ③ Finish Color (see page 36)

Access Panel

- ① Model Number
- ② Wood Species or Paint - Makore (MK2), Maple (MA2), Walnut (WA2), Double Cut (DC1) or Paint (PNT) (see page 36)
- ③ Finish Color (see page 36)

Note: Only one wood finish and one paint color can be specified per unit

Description	D	W	H	CTN WT	CU FT	① Model	List Price
85½" h Storage Unit with Drawer and Flush Base	22	18	85½	214	25	AP6-DDT-B-2218R	\$3,885
	22	18	85½	214	25	AP6-DDT-B-2218L	\$3,885

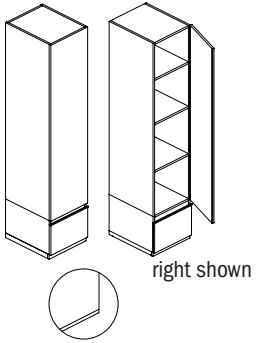

- base is flush
- three adjustable shelves
- pedestal front locking
- door side has concealed bevel for opening
- soft close hinge door
- locking door available, specify and add \$105 list
- adjustable levelers/glides

85½" h Storage Unit with Drawer and Inset Base	22	18	85½	211	25	AP6-DDT-BR-2218R	\$3,885
	22	18	85½	211	25	AP6-DDT-BL-2218L	\$3,885

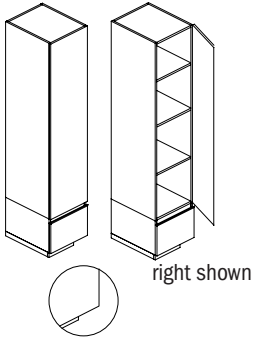

- base is inset on one side
- three adjustable shelves
- pedestal front locking
- door side has concealed bevel for opening
- soft close hinge door
- locking door available, specify and add \$105 list
- adjustable levelers/glides

must be mounted

Description	D	W	H	CTN WT	CU FT	① Model	List Price
85 ½" h Wardrobe Unit with Drawer and Flush Base	22	18	85 ½	201	25	AP6-DDT-A-2218R	\$3,696
	22	18	85 ½	201	25	AP6-DDT-A-2218L	\$3,696

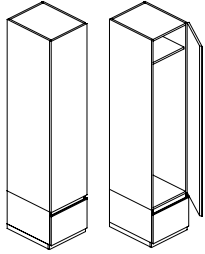

right shown

- base is flush
- fixed shelf
- hanging bar
- pedestal front locking
- door side has concealed bevel for opening
- soft close hinge door
- locking door available, specify and add \$105 list
- adjustable leveler/glides

85 ½" h Wardrobe Unit with Drawer and Inset Base	22	18	85 ½	198	25	AP6-DDT-AR-2218R	\$3,696
	22	18	85 ½	198	25	AP6-DDT-AL-2218L	\$3,696

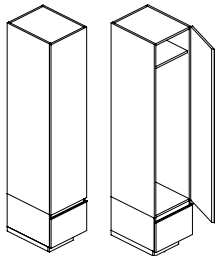

right shown

- base is inset on one side
- fixed shelf
- hanging bar
- pedestal front locking
- door side has concealed bevel for opening
- soft close hinge door
- locking door available, specify and add \$105 list
- adjustable leveler/glides

must be mounted

To Order, Specify:

① Model Number

② Finish Application

A. All Veneer

1. Wood Species - Makore (MK2), Maple (MA2), Walnut (WA2) or Double Cut (DC1) (see page 36)

a. Finish Color (see page 36)

B. All Paint (PNT)

1. Paint Color (see page 36)

C. Veneer/Paint Combination

1. Upper Chassis Wood Species/Paint - Makore (MK2), Maple (MA2), Walnut (WA2), Double Cut (DC1) or Paint (PNT) (see page 36)

a. Finish Color for Upper Chassis (see page 36)

2. Lower Chassis Wood Species/Paint - Makore (MK2), Maple (MA2), Walnut (WA2), Double Cut (DC1) or Paint (PNT) (see page 36)

a. Finish Color for Lower Chassis (see page 36)

3. Finish Color for Base

- a. Same as Upper Chassis
- b. Same as Lower Chassis

Note: Only one wood finish and one paint color can be specified per unit

Description	D	W	H	CTN WT	CU FT	① Model	List Price
85 1/2" h Storage Unit with Flush Base	22	18	85 1/2	195	25	AP6-ADT-2-2218R	\$3,318
	22	18	85 1/2	195	25	AP6-ADT-2-2218L	\$3,318

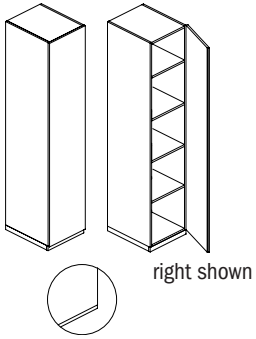

- base is flush
- four adjustable shelves
- door side has concealed bevel for opening
- soft close hinge door
- locking door available, specify and add \$105 list
- adjustable levelers/glides

85 1/2" h Storage Unit with Inset Base	22	18	85 1/2	192	25	AP6-ADT-2R-2218R	\$3,318
	22	18	85 1/2	192	25	AP6-ADT-2L-2218L	\$3,318

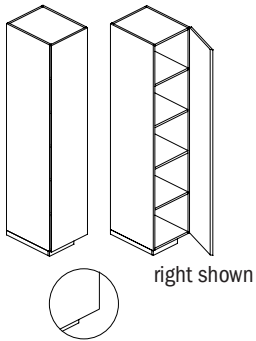

- base is inset on one side
- four adjustable shelves
- door side has concealed bevel for opening
- soft close hinge door
- locking door available, specify and add \$105 list
- adjustable levelers/glides

must be mounted

85 1/2" h Wardrobe Unit with Flush Base	22	18	85 1/2	176	25	AP6-ADT-1-2218R	\$3,066
	22	18	85 1/2	176	25	AP6-ADT-1-2218L	\$3,066

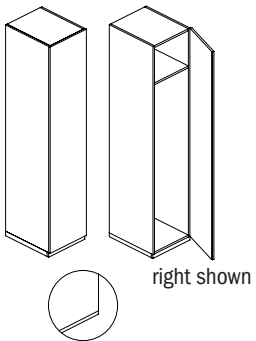

- base is flush
- fixed shelf
- hanging bar
- door side has concealed bevel for opening
- soft close hinge door
- locking door available, specify and add \$105 list
- adjustable leveler/glides

85 1/2" h Wardrobe Unit with Inset Base	22	18	85 1/2	172	25	AP6-ADT-1R-2218R	\$3,066
	22	18	85 1/2	172	25	AP6-ADT-1L-2218L	\$3,066

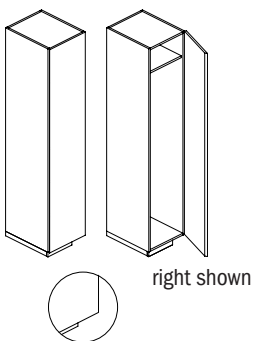

- base is inset on one side
- fixed shelf
- hanging bar
- door side has concealed bevel for opening
- soft close hinge door
- locking door available, specify and add \$105 list
- adjustable leveler/glides

must be mounted

Description	D	W	H	CTN WT	CU FT	① Model	List Price
85 1/2" h Wardrobe Unit with Flush Base	22	12	85 1/2	141	17	AP6-ADT-1-2212R	\$2,699
	22	12	85 1/2	141	17	AP6-ADT-1-2212L	\$2,699

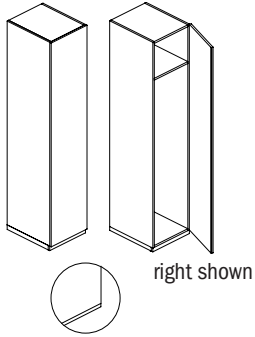

- base is flush
- fixed shelf
- coat hook
- door side has concealed bevel for opening
- soft close hinge door
- locking door available, specify and add \$105 list
- adjustable leveler/glides

must be mounted
 Note: Not a Freestanding Unit

85 1/2" h Wardrobe Unit with Inset Base	22	12	85 1/2	138	17	AP6-ADT-1R-2212R	\$2,699
	22	12	85 1/2	138	17	AP6-ADT-1L-2212L	\$2,699

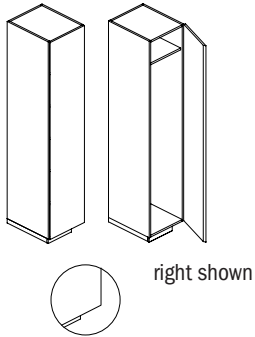

- base is inset on one side
- fixed shelf
- coat hook
- door side has concealed bevel for opening
- soft close hinge door
- locking door available, specify and add \$105 list
- adjustable leveler/glides

must be mounted
 Note: Not a Freestanding Unit

To Order, Specify:

- ① Model Number
- ② Wood Species/Paint on Chassis/Door Fronts - Makore (MK2), Maple (MA2), Walnut (WA2), Double Cut (DC1) or Paint (PNT) (see page 36)
- ③ Finish Color for Chassis/Door Fronts (see page 36)
- ④ Finish Color for Base
 - A. Same as Chassis/Drawer Front
 - B. Paint (see page 36)

Note: Only one wood finish and one paint color can be specified per unit

APOGEE™

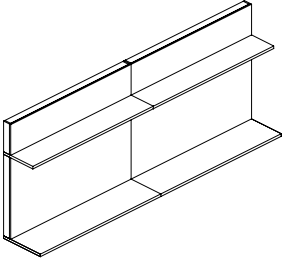
Description	D	W	H	CTN WT	CU FT	① Model	List Price
144" w Dual Open Workwall with Shelf  <ul style="list-style-type: none"> · wall mounted · workwall top included (17¾" deep) · one fixed shelf · shipped in four sections · finish scheme <ul style="list-style-type: none"> -workwall top - veneer only -chassis and shelves - veneer or paint · two grommets 31" off center of each section of the workwall available, specify and add \$158 list · aluminum mini shelf available, specify and add \$1,565 list; an insert back panel is required when ordering a mini shelf · back insert panel between shelf and top available, indicate selection on order and select appropriate list price; panel reduces workwall by 1" <ul style="list-style-type: none"> -veneer panel -paint panel -magnetic back painted white glass with thin aluminum frame and 6 magnets -tackable fabric panel - com ydg: 5 <p>Note: use insert panel when wanting to add contrast</p>	22	144	57	568	124	AM4-CWO-SP-22144	W/O PANEL \$11,004 VENEER PANEL \$12,621 PAINT PANEL \$12,621 GLASS PANEL \$15,902 FABRIC PANEL COM \$12,029 A \$12,080 B \$12,176 C \$12,348 D \$12,569 E \$12,787 F \$13,130 G \$13,497 H \$13,888 I \$14,499 J \$15,232

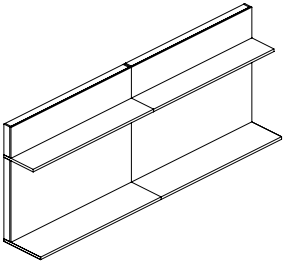
120" w Dual Open Workwall with Shelf  <ul style="list-style-type: none"> · wall mounted · workwall top included (17¾" deep) · one fixed shelf · shipped in four sections · finish scheme <ul style="list-style-type: none"> -workwall top - veneer only -chassis and shelves - veneer or paint · two grommets 25" off center of each section of the workwall available, specify and add \$158 list · aluminum mini shelf available, specify and add \$1,407 list; an insert back panel is required when ordering a mini shelf · back insert panel between shelf and top available, indicate selection on order and select appropriate list price; panel reduces workwall by 1" <ul style="list-style-type: none"> -veneer panel -paint panel -magnetic back painted white glass with thin aluminum frame and 6 magnets -tackable fabric panel - com ydg: 4½" <p>Note: use insert panel when wanting to add contrast</p>	22	120	57	474	104	AM4-CWO-SP-22120	W/O PANEL \$10,248 VENEER PANEL \$11,676 PAINT PANEL \$11,676 GLASS PANEL \$14,182 FABRIC PANEL COM \$11,223 A \$11,269 B \$11,355 C \$11,511 D \$11,708 E \$11,905 F \$12,214 G \$12,544 H \$12,894 I \$13,445 J \$14,104
--	----	-----	----	-----	-----	------------------	---

Description	D	W	H	CTN WT	CU FT	① Model	List Price
144" w Dual Wardrobe Workwall with Sliding Doors	22	144	57	588	140	AM4-CWW-1-22144	\$14,658

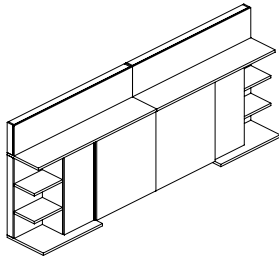

- must order work center section on page 54
- wall mounted
- workwall top included
- shipped in four sections
- left and right side
 - 18" w fixed outer shelves
 - 18" w storage/wardrobe (sliding interior bi-pass door) adjustable shelves and coat hook
- finish scheme
 - workwall top - veneer only
 - chassis, interior sliding doors and shelves
 - veneer
 - paint
 - exterior 36" w sliding doors
 - veneer
 - paint
 - back painted white glass with thin aluminum frame, add \$1,966 list
 - magnetic back painted white glass with thin aluminum frame and 6 magnets, add \$2,310 list

120" w Dual Wardrobe Workwall with Sliding Doors	22	120	57	448	118	AM4-CWW-1-22120	\$13,860
---	----	-----	----	-----	-----	------------------------	-----------------

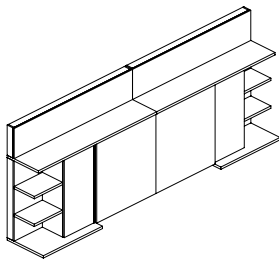

- must order work center section on page 54
- wall mounted
- workwall top included
- shipped in four sections
- left and right side
 - 15" w fixed outer shelves
 - 15" w storage/wardrobe (sliding interior bi-pass door) adjustable shelves and coat hook
- finish scheme
 - workwall top - veneer only
 - chassis, interior sliding doors and shelves
 - veneer
 - paint
 - exterior 30" w sliding doors
 - veneer
 - paint
 - back painted white glass with thin aluminum frame, add \$1,809 list
 - magnetic back painted white glass with thin aluminum frame and 6 magnets, add \$2,124 list

To Order, Specify:

Open Workwall

- ① Model Number
- ② Wood Species on Top - Makore (MK2), Maple (MA2) Walnut (WA2) or Double Cut (DC1) (see page 36)
- ③ Finish Color for Top (see page 36)
- ④ Finish Color for Chassis/Shelves
 - A. Same as Top
 - B. Paint Color (see page 36)

Wardrobe Workwall

- ① Model Number
- ② Wood Species on Top - Makore (MK2), Maple (MA2) Walnut (WA2) or Double Cut (DC1) (see page 36)
- ③ Finish Color for Top (see page 36)
- ④ Finish Color for Chassis, Interior Sliding Doors and Shelves
 - A. Same as Top
 - B. Paint Color (see page 36)
- ⑤ Exterior Sliding Doors
 - A. Same as Top
 - B. Paint Color (see page 36)
 - C. Glass

Note: Only one wood finish and one paint color can be specified per unit

Description	D	W	H	CTN WT	CU FT	① Model	List Price
-------------	---	---	---	-----------	----------	---------	------------

144" w Dual Shelf Workwall with Sliding Doors

22 144 57 556 136 AM4-CWS-1-22144 \$11,907

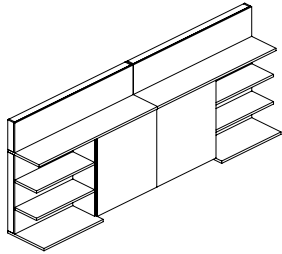

- must order work center section on page 54
- wall mounted
- workwall top included
- shipped in four sections
- left and right side
 - 36" w fixed outer shelves
- finish scheme
 - workwall top - veneer only
 - chassis and shelves
 - veneer
 - paint
 - exterior 36" w sliding doors
 - veneer
 - paint
 - back painted white glass with thin aluminum frame, add \$1,966 list
 - magnetic back painted white glass with thin aluminum frame and 6 magnets, add \$2,310 list

120" w Dual Shelf Workwall with Sliding Doors

22 120 57 420 112 AM4-CWS-1-22120 \$11,340

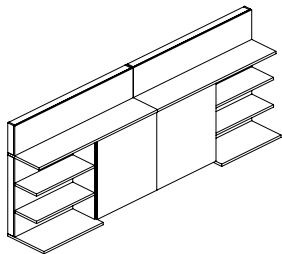

- must order work center section on page 54
- wall mounted
- workwall top included
- shipped in four sections
- left and right side
 - 30" w fixed outer shelves
- finish scheme
 - workwall top - veneer only
 - chassis and shelves
 - veneer
 - paint
 - exterior 30" w sliding doors
 - veneer
 - paint
 - back painted white glass with thin aluminum frame, add \$1,809 list
 - magnetic back painted white glass with thin aluminum frame and 6 magnets, add \$2,124 list

Description	D	W	H	CTN WT	CU FT	① Model	List Price
144" w Dual Display Workwall with Sliding Doors	22	144	57	512	136	AM4-CWD-1-22144	\$11,277

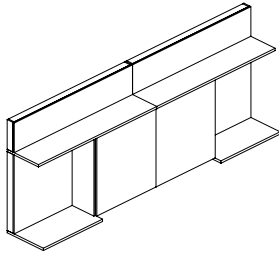

- must order work center section on page 54
- wall mounted
- workwall top included
- shipped in four sections
- left and right side
 - 36" w display area
- finish scheme
 - workwall top - veneer only
 - chassis and shelves
 - veneer
 - paint
 - exterior 36" w sliding doors
 - veneer
 - paint
 - back painted white glass with thin aluminum frame, add \$1,966 list
 - magnetic back painted white glass with thin aluminum frame and 6 magnets, add \$2,310 list

120" w Dual Display Workwall with Sliding Doors	22	120	57	386	112	AM4-CWD-1-22120	\$10,710
---	----	-----	----	-----	-----	-----------------	----------

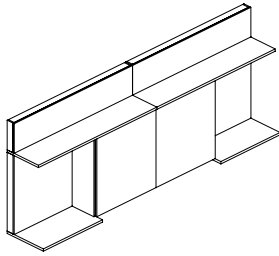

- must order work center section on page 54
- wall mounted
- workwall top included
- shipped in four sections
- left and right side
 - 30" w display area
- finish scheme
 - workwall top - veneer only
 - chassis and shelves
 - veneer
 - paint
 - exterior 30" w sliding doors
 - veneer
 - paint
 - back painted white glass with thin aluminum frame, add \$1,809 list
 - magnetic back painted white glass with thin aluminum frame and 6 magnets, add \$2,124 list

To Order, Specify:

- ① Model Number
- ② Wood Species on Top - Makore (MK2), Maple (MA2) Walnut (WA2) or Double Cut (DC1) (see page 36)
- ③ Finish Color for Top (see page 36)
- ④ Finish Color for Chassis and Shelves
 - A. Same as Top
 - B. Paint Color (see page 36)
- ⑤ Exterior Sliding Doors
 - A. Same as Top
 - B. Paint Color (see page 36)
 - C. Glass

Note: Only one wood finish and one paint color can be specified

per unit

Description	D	W	H	CTN WT	CU FT	① Model	List Price
Media Workcenter	22	72	41	291	45	AM4-CZW-06-22144	\$2,562
	22	60	41	243	38	AM4-CZW-06-22120	\$2,457

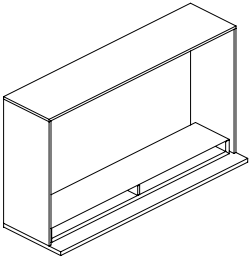

- -22144 use with 144" w workwall with sliding doors
- -22120 use with 120" w workwall with sliding doors
- wall mounted
- workwall top included
- wire pass thru
- -22144 cubby opening 34" w each
- -22120 cubby opening 28" w each

APOGEE™

Magnets				3	1	GP9-MAG-1-0101	\$66
---------	--	--	--	---	---	----------------	------

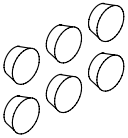

- may be used with magnetic glass panels
- white
- pack of 6

To Order, Specify:

Media Workcenter

- ① Model Number
- ② Wood Species on Top - Makore (MK2), Maple (MA2)
Walnut (WA2) or Double Cut (DC1)
(see page 36)
- ③ Finish Color for Top (see page 36)
- ④ Finish Color for Chassis
 - A. Same as Top
 - B. Paint (see page 36)
- ⑤ Cubby and Niche Paint Color

Magnets

- ① Model Number

Note: Only one wood finish and one paint color can be specified per unit

Broadway Conference Product Information



BROADWAY

Broadway Conference Product Information

Exterior Wood Materials

Exterior surfaces are made from the finest selected veneers to achieve clarity and consistency in the Broadway product line. To attain a pleasing, symmetrical pattern, all veneers in Broadway are book-matched. All exterior solid lumber is matched to coordinate with the veneer.

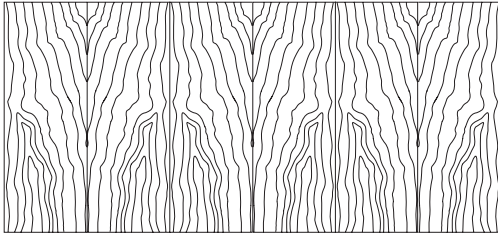

Book Matched Example

Alternating pieces of veneer are flipped over so they face each other like the pages within a book.

Broadway is available in flat cut cherry, maple and walnut veneer. A wide range of wood stains have been formulated to enhance the beauty of the veneer.

Solid painted finishes on the veneer are also offered to provide an accent to the Broadway product.

Work Surface Construction

Tops are 5-ply balanced construction, 1 1/2" thick with solid matching hardwood edges.

Matching or coordinating high pressure laminate in a veneer grain can be applied to the top surface and is available at no additional charge.

Case Construction

Outside panels are 13/16" and joined together by mortise and tenon construction. In addition to mortise and tenon joint construction, pedestal joints are reinforced with screws, cleats, brackets and glue. Leveling glides are set into solid hardwood blocks with t-nut inserts, which helps to prevent the leveling glide from tear out. Tops are secured to the chassis with top fastening cleats screwed to the inside of the panels.

Drawers

The 9ply unidirectional hardwood sides of the drawer box are 7/16" thick assembled with English dovetail construction at each corner of the box. The drawer bottom panel is 1/4" thick fitting into a groove machined into the side of the box. Interiors are sanded and coated with clear U.V. finish to protect against shrinking, swelling or warping, and to provide a clean, smooth feel and appearance.

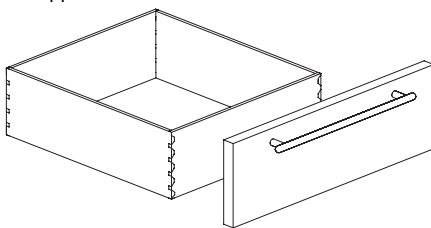

Drawer Suspension

The high quality black drawer suspensions carry a lifetime warranty. Slides feature steel ball bearings for longer life with cushioned in/out stops. File and box drawers have 100% full extension with over travel.

Finish - Stain/Colors

We offer a variety of wood stains and paint colors on Broadway. Please see the chart below. Samples are available upon request. Former finish names are listed in parentheses for reference.

CH1 Cherry		<i>Flat Cut Veneer</i>	
AUT	Autumn (<i>Autumn Cherry</i>)	EAR	Earthy
BRL	Barley	LGC	Legacy (<i>Legacy Cherry</i>)
BBN	Bourbon (<i>Natural Cherry</i>)	PRL	Praline (<i>Vintage Cherry</i>)
BRG	Brighton (<i>Brighton Cherry</i>)	SAF	Saffron (<i>Medium Cherry</i>)
CLA	Classic (<i>Classic Cherry</i>)		

MA1 Maple		<i>Flat Cut Veneer</i>	
ALE	Ale (<i>Natural Maple</i>)	FLX	Flax
BUT	Butterscotch	VEN	Venetian (<i>Dark Mahogany</i>)
CIN	Cinnamon		

WA1 Walnut		<i>Flat Cut Veneer</i>	
AUB	Auburn (<i>Windsor Mahogany</i>)	SIE	Sienna
ESP	Espresso	TOF	Toffee
MCH	Mocha	TRF	Truffle
NTO	Night Owl (<i>Vintage Walnut</i>)		

PNT Paint		<i>Maple Flat Cut Veneer</i>	
BKD	Backdrop	GRV	Greek Villa
BFX	Black Fox	NET	Network Gray
BWH	Bright White	NWH	Nonchalant White
CGP	Cargo Pants	STM	Storm
CHT	Chatroom	TRC	Tricom Black
FRR	French Roast		

Protective Top Coat

DuraTex™ offers exceptional hardness along with abrasion and impact resistance, it has been formulated to eliminate hazardous and harmful gases that are normally associated with wood finish.

DuraTex™ Features

Safety - Significantly reduces hazardous formaldehyde emissions, which help improve the quality of the indoor air we breathe.

Quality - Developed to be tough and durable with special attention to appearance. The DuraTex™ finish preserves the natural beauty of wood.

Durability - Designed to meet a wide range of demanding performance and environmental standards to withstand even the highest wear and tear.

Broadway Conference Product Information

Product Modification

Laminate Tops

Worksurface only, no additional upcharge if coordinating wood grain laminate is specified. Contact Customer Service for any other laminate request. Listed below are finishes that have coordinating wood grain HPL laminates.

Cherry Finishes	Maple Finishes	Walnut Finishes
<i>Autumn</i>	<i>Ale</i>	<i>Auburn</i>
<i>Barley</i>	<i>Cinnamon</i>	<i>Mocha</i>
<i>Bourbon</i>	<i>Venetian</i>	<i>Night Owl</i>
<i>Brighton</i>		<i>Sienna</i>
<i>Classic</i>		<i>Toffee</i>
<i>Legacy</i>		<i>Truffle</i>
<i>Praline</i>		
<i>Saffron</i>		

Special Finishes

Special finishes can be requested by following the instruction in the general introduction section, page 3. There is a one time charge of \$289 list per order.

Finish Sheen Modification

Finish sheen can be modified on the worksurface tops. There is a 15% upcharge added to the list of each item.

Two-Tone Finish

Units specified in a two tone finish (either two different paint finishes or a paint finish and wood stain) requires approval with an upcharge of 8% to the list price. Color paint finishes are formulated for maple veneers and are not available on any worksurfaces.

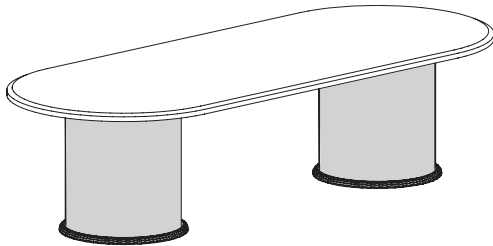

Oak Veneer

Upon request veneer can be changed from the standard offering to oak flat cut veneer with an additional 40% upcharge to the list of each item.

Broadway Conference Product Information

Top Edge Details

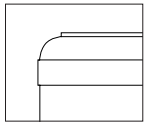

Classic (L)

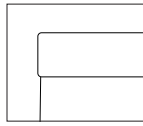

Eased (R5)

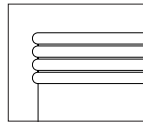

Reeded (N)

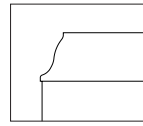

Squire (K2)

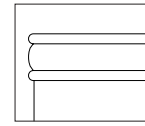

Transitional (M)

Pull Style and Color Options

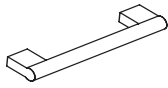

Bar
Matte Black (MBK)
Polished Nickel (PNK)



Bask
Polished Nickel (PNK)

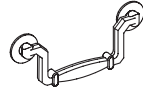

Belmont
Burnished Brass (BBR)

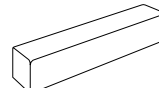

Block
Matte Nickel (MNK)



Bow
Matte Nickel (MNK)



Curve
Matte Nickel (MNK)

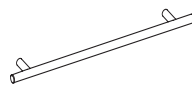

Lineal
Matte Nickel (MNK)



Scoop
Matte Black (MBK)
Polished Nickel (PNK)



Transitional
Matte Nickel (MNK)



Wedge
Matte Nickel (MNK)

Top Shapes - size - base requirement - seating capacity

top sizes 108" through 192" are 2 pieces

top sizes above 192" are 3 pieces

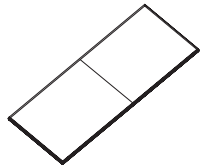

size	base requirement	seating capacity
264" x 60"	4 bases	seats 24
240" x 60"	4 bases	seats 22
216" x 60"	4 bases	seats 20
192" x 60"	3 bases	seats 18
264" x 54"	4 bases	seats 22
240" x 54"	4 bases	seats 20
216" x 54"	4 bases	seats 18
192" x 54"	3 bases	seats 16
264" x 48"	4 bases	seats 22
240" x 48"	4 bases	seats 20
216" x 48"	4 bases	seats 18
192" x 48"	3 bases	seats 16
168" x 48"	3 bases	seats 14
144" x 48"	3 bases	seats 12
120" x 48"	2 bases	seats 8
120" x 42"	2 bases	seats 8
108" x 42"	2 bases	seats 8
96" x 48"	2 bases	seats 8
96" x 42"	2 bases	seats 8
84" x 42"	2 bases	seats 8
72" x 36"	2 bases	seats 6



size	base requirement	seating capacity
264" x 60"	4 bases	seats 24
240" x 60"	4 bases	seats 22
216" x 60"	4 bases	seats 20
192" x 60"	3 bases	seats 18
264" x 54"	4 bases	seats 22
240" x 54"	4 bases	seats 20
216" x 54"	4 bases	seats 18
192" x 54"	3 bases	seats 16
264" x 48"	4 bases	seats 22
240" x 48"	4 bases	seats 20
216" x 48"	4 bases	seats 18
192" x 48"	3 bases	seats 16
168" x 48"	3 bases	seats 14
144" x 48"	3 bases	seats 12
120" x 48"	2 bases	seats 8
120" x 42"	2 bases	seats 8
108" x 42"	2 bases	seats 8
96" x 48"	2 bases	seats 8
96" x 42"	2 bases	seats 8
84" x 42"	2 bases	seats 8
72" x 36"	2 bases	seats 6

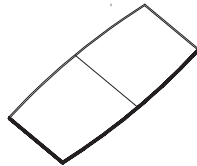

size	base requirement	seating capacity
264" x 60"	4 bases	seats 24
240" x 60"	4 bases	seats 22
216" x 60"	4 bases	seats 20
192" x 60"	3 bases	seats 18
264" x 54"	4 bases	seats 22
240" x 54"	4 bases	seats 20
216" x 54"	4 bases	seats 18
192" x 54"	3 bases	seats 16
264" x 48"	4 bases	seats 22
240" x 48"	4 bases	seats 20
216" x 48"	4 bases	seats 18
192" x 48"	3 bases	seats 16
168" x 48"	3 bases	seats 14
144" x 48"	3 bases	seats 12
120" x 48"	2 bases	seats 8
120" x 42"	2 bases	seats 8
108" x 42"	2 bases	seats 8
96" x 48"	2 bases	seats 8
96" x 42"	2 bases	seats 8
84" x 42"	2 bases	seats 8
72" x 36"	2 bases	seats 6



size	base requirement	seating capacity
60" dia.	Seats 6	
54" dia.	Seats 6	
48" dia.	Seats 4	
42" dia.	Seats 4	
36" dia.	Seats 4	

*requires 1 base

square*

60" sq.	seats 8
54" sq.	seats 6
48" sq.	seats 4
42" sq.	seats 4
36" sq.	seats 4
30" sq.	seats 4

*requires 1 base

Bases

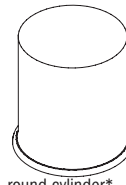

round cylinder*

24" dia.	use with 60"/54" width top
20" dia.	use with 42"/48" width top
18" dia.	use with 36" width tops



half round*

12" radius	use 54" width top
10" radius	use with 42"/48" width top
9" radius	use with 36" width top

Units with access panel in the base for wire management are available, order this feature with appropriate model number.

*Base molding options are the same as top profile options and, must specify at the time of order placement

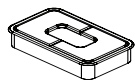

Worksurface Grommet

Additional worksurface grommets can be specified on veneer/laminate worksurfaces. The grommet location must be approved by JSI manufacturing, contact Customer Service. Add \$79 to the list for each additional grommet.

Grommet color must be specified, select Matte Black or Stardust Silver. Lock cores will match grommet color

Matte Black (MBK)
Stardust Silver (STS)

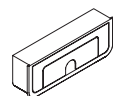

End/Back Panel Grommet

The end/back panel grommets are standard, for any special consideration contact Customer Service.

Broadway Conference Product Information

Finish and Product Reference Codes

Select	Code
--------	------

Veneer

Cherry Flat Cut	CH1
Maple Flat Cut	MA1
Walnut Flat Cut	WA1

Finish

Cherry Finishes

Autumn	AUT
Barley	BRL
Bourbon	BBN
Brighton	BRG
Classic	CLA
Earthy	EAR
Legacy	LGC
Praline	PRL
Saffron	SAF

Maple Finishes

Ale	ALE
Butterscotch	BUT
Cinnamon	CIN
Flax	FLX
Venetian	VEN

Select	Code
--------	------

Walnut Finishes

Auburn	AUB
Espresso	ESP
Mocha	MCH
Night Owl	NTO
Sienna	SIE
Toffee	TOF
Truffle	TRF

Paint Finishes

Backdrop	BKD
Black Fox	BFX
Bright White	BWH
Cargo Pants	CGP
Chatroom	CHT
French Roast	FRR
Greek Villa	GRV
Network Gray	NET
Nonchalant White	NWH
Storm	STM
TRC	TRC

Select	Code
--------	------

Laminate Coordinates

Cherry Wood Grain Patterns

Autumn	AUT
Barley	BRL
Bourbon	BBN
Brighton	BRG
Classic	CLA
Legacy	LGC
Praline	PRL
Saffron	SAF

Maple Wood Grain Patterns

Ale	ALE
Cinnamon	CIN
Venetian	VEN

Walnut Wood Grain Patterns

Auburn	AUB
Mocha	MCH
Night Owl	NTO
Sienna	SIE
Toffee	TOF
Truffle	TRF

Metal Finish





Matte Black	MBK
Stardust Silver	STS

Order Check List:

Specify:

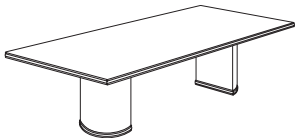
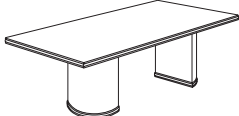
- 1. Model Number
- 2. Finish Scheme/Color (see page 57)
- 3. Wood Species - cherry - maple - walnut
- 4. Top Options
- 5. Other Product Options
- 6. Power and Data Accessories (*drawing showing location and orientation must accompany order*)
- 7. Side Mark Information (*i.e. room number, East Conference Room*)
- 8. Shipping Address (*contact name and phone number*)
- 9. Special Delivery Instructions (*i.e. call before delivery, deliver to job site*)

Broadway Conference Product Information

Description	D	W	H	CTN WT	CU FT	① Model	List Price	
Conference Table 	42	96	30			BR4296CTH	\$4,948	
	Consists of:							
					203	15	BR4296TT - Table Top	\$3,120
				70	5	BR20HRB - Half Round Base	\$1,828	
<ul style="list-style-type: none"> · ships KD in two cartons · specify edge for top and bases · one piece top · price reflects two bases · price includes one BR0638PS stretcher panel 								
Conference Table 	36	72	30			BR3672CTH	\$4,002	
	Consists of:							
					130	10	BR3672TT - Table Top	\$2,240
				39	4	BR18HRB - Half Round Base	\$1,762	
<ul style="list-style-type: none"> · ships KD in two cartons · specify edge for top and bases · one piece top · base price reflects two bases 								
Round Conference Table 	48	48	30			BR48CTD	\$2,969	
	Consists of:							
					87	7	BR48TT - Table Top	\$1,848
				83	9	BR20RB - Round Base	\$1,121	
<ul style="list-style-type: none"> · ships KD in two cartons 								
Round Conference Table 	42	42	30			BR42CTD	\$2,454	
	Consists of:							
					67	5	BR42TT - Table Top	\$1,333
				83	9	BR20RB - Round Base	\$1,121	
<ul style="list-style-type: none"> · ships KD in two cartons 								
Lounge Height Meeting Table 	42	42	16			BR42MTD	\$2,391	
	Consists of:							
					67	5	BR42TT - Table Top	\$1,333
				79	5	BR18-16RB - Round Base	\$1,058	
<ul style="list-style-type: none"> · ships KD in two cartons 								
Lounge Height Meeting Table 	36	36	16			BR36MTD	\$2,231	
	Consists of:							
					50	4	BR36TT - Table Top	\$1,173
				79	5	BR18-16RB - Round Base	\$1,058	
<ul style="list-style-type: none"> · ships KD in two cartons 								

To Order, Specify:

- ① Model Number
- ② Wood Species
 - A. Work Surface
 - B. Chassis
- ③ Finish Color
 - A Work Surface
 - B. Chassis
- ④ Edge Profile
- ⑤ Power and Data Options (see page 322)
- ⑥ Other Product Options

BROADWAY

Description	① Model	W	L	Seat Capacity	Top Pieces	Bases Required	CTN WT	CU FT	List Price
Rectangular Tops 	BR60264TT	60	264	24	3	4	850	57	\$14,736
	BR60240TT	60	240	22	3	4	774	51	\$13,395
	BR60216TT	60	216	20	3	4	698	48	\$12,059
	BR60192TT	60	192	18	2	3	619	42	\$10,717
	BR54264TT	54	264	22	3	4	718	52	\$12,280
	BR54240TT	54	240	20	3	4	653	50	\$11,163
	BR54216TT	54	216	18	3	4	587	43	\$10,049
	BR54192TT	54	192	16	2	3	520	38	\$8,931
	BR48264TT	48	264	22	3	4	645	47	\$10,917
	BR48240TT	48	240	20	3	4	586	43	\$8,933
	BR48216TT	48	216	18	3	4	526	38	\$8,037
	BR48192TT	48	192	16	2	3	467	33	\$7,147
	BR48168TT	48	168	14	2	3	407	30	\$6,949
	BR48144TT	48	144	12	2	3	348	28	\$5,971
	BR48120TT	48	120	8	2	2	289	22	\$4,467
	BR4896TT	48	96	8	1	2	249	17	\$3,565
	BR42120TT	42	120	8	2	2	256	19	\$4,343
	BR42108TT	42	108	8	2	2	230	17	\$3,912
	BR4296TT	42	96	8	1	2	203	15	\$3,120
	BR4284TT	42	84	8	1	2	191	13	\$2,727
BR3672TT	36	72	6	1	2	130	10	\$2,240	

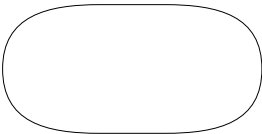
Description	① Model	W	L	Seat Capacity	Top Pieces	Bases Required	CTN WT	CU FT	List Price
Racetrack Tops 	BR60264RT	60	264	24	3	4	816	57	\$16,949
	BR60240RT	60	240	22	3	4	744	51	\$15,405
	BR60216RT	60	216	20	3	4	670	48	\$13,868
	BR60192RT	60	192	18	2	3	595	42	\$12,324
	BR54264RT	54	264	22	3	4	690	52	\$14,123
	BR54240RT	54	240	20	3	4	624	50	\$12,838
	BR54216RT	54	216	18	3	4	558	43	\$11,557
	BR54192RT	54	192	16	2	3	492	38	\$10,271
	BR48264RT	48	264	22	3	4	622	47	\$12,556
	BR48240RT	48	240	20	3	4	563	43	\$10,273
	BR48216RT	48	216	18	3	4	504	38	\$9,244
	BR48192RT	48	192	16	2	3	444	33	\$8,218
	BR48168RT	48	168	14	2	3	385	30	\$7,992
	BR48144RT	48	144	12	2	3	326	28	\$6,866
	BR48120RT	48	120	8	2	2	267	22	\$5,138
	BR4896RT	48	96	8	1	2	234	17	\$4,100
	BR42120RT	42	120	8	2	2	238	19	\$4,994
	BR42108RT	42	108	8	2	2	212	17	\$4,498
	BR4296RT	42	96	8	1	2	185	15	\$3,588
	BR4284RT	42	84	8	1	2	180	13	\$3,129
BR3672RT	36	72	6	1	2	117	10	\$2,576	

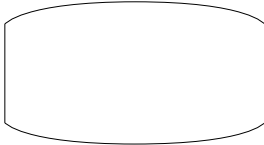
Description	① Model	W	L	Seat Capacity	Top Pieces	Bases Required	CTN WT	CU FT	List Price
Boat Shape Tops 	BR60264BT	60	264	24	3	4	816	57	\$16,949
	BR60240BT	60	240	22	3	4	744	51	\$15,405
	BR60216BT	60	216	20	3	4	670	48	\$13,868
	BR60192BT	60	192	18	2	3	595	42	\$12,324
	BR54264BT	54	264	22	3	4	690	52	\$14,123
	BR54240BT	54	240	20	3	4	624	50	\$12,838
	BR54216BT	54	216	18	3	4	558	43	\$11,557
	BR54192BT	54	192	16	2	3	492	38	\$10,271
	BR48264BT	48	264	22	3	4	622	47	\$12,556
	BR48240BT	48	240	20	3	4	563	43	\$10,273
	BR48216BT	48	216	18	3	4	504	38	\$9,244
	BR48192BT	48	192	16	2	3	444	33	\$8,218
	BR48168BT	48	168	14	2	3	385	30	\$7,992
	BR48144BT	48	144	12	2	3	326	28	\$6,866
	BR48120BT	48	120	8	2	2	267	22	\$5,138
	BR4896BT	48	96	8	1	2	234	17	\$4,100
	BR42120BT	42	120	8	2	2	238	19	\$4,994
	BR42108BT	42	108	8	2	2	212	17	\$4,498
	BR4296BT	42	96	8	1	2	185	15	\$3,588
	BR4284BT	42	84	8	1	2	180	13	\$3,129
BR3672BT	36	72	6	1	2	117	10	\$2,576	

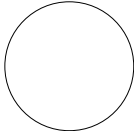
Description	① Model	W	L	Seat Capacity	Top Pieces	Bases Required	CTN WT	CU FT	List Price
Round Tops 	BR60TT	60	N/A	6	1	1	134	10	\$3,690
	BR54TT	54	N/A	6	1	1	109	8	\$2,769
	BR48TT	48	N/A	4	1	1	87	7	\$1,848
	BR42TT	42	N/A	4	1	1	67	5	\$1,333
	BR36TT	36	N/A	3	1	1	50	4	\$1,173
	BR30TT	30	N/A	3	1	1	36	3	\$1,035

Description	① Model	W	L	Seat Capacity	Top Pieces	Bases Required	CTN WT	CU FT	List Price
Square Tops 	BR6060TT	60	60	8	1	1	195	10	\$3,353
	BR5454TT	54	54	6	1	1	158	8	\$2,717
	BR4848TT	48	48	4	1	1	125	7	\$2,147
	BR4242TT	42	42	4	1	1	98	5	\$1,644
	BR3636TT	36	36	4	1	1	71	4	\$1,208
	BR3030TT	30	30	4	1	1	49	3	\$839

To Order, Specify:

- ① Model Number
- ② Wood Species
- ③ Finish Color
- ④ Edge Profile
- ⑤ Power and Data Options (see page 322)
- ⑥ Other Product Options

Description	D	W	H	CTN WT	CU FT	① Model	List Price
Round Base 	24	N/A	28 3/4	89	12	BR24RB · for use with 54" and 60" width top	\$1,259
	24	N/A	28 3/4	52	12	BR24RBA · for use with 54" and 60" width top · access panel	\$1,362
	20	N/A	28 3/4	83	9	BR20RB · for use with 42" and 48" width top	\$1,121
	20	N/A	28 3/4	46	9	BR20RBA · for use with 42" and 48" width top · access panel	\$1,224
	18	N/A	28 3/4	78	7	BR18RB · for use with 36" width top	\$1,058
	18	N/A	28 3/4	41	7	BR18RBA · for use with 36" width top · access panel	\$1,162

· specify edge treatment

Half Round Base 	12	24	28 3/4	50	6	BR24HRB · for use with 54" width top	\$986
	12	24	28 3/4	48	6	BR24HRBA · for use with 54" width top · access panel	\$1,109
	10	20	28 3/4	44	5	BR20HRB · for use with 42" and 48" width top	\$914
	10	20	28 3/4	42	5	BR20HRBA · for use with 42" and 48" width top · access panel	\$1,038
	9	18	28 3/4	39	4	BR18HRB · for use with 36" width top	\$881
	9	18	28 3/4	37	4	BR18HRBA · for use with 36" width top · access panel	\$1,006

· specify edge treatment

BROADWAY

Description	D	W	H	CTN WT	CU FT	❶ Model	List Price
Conference Lectern	23	27	48	250		BR2622LEC	\$2,728

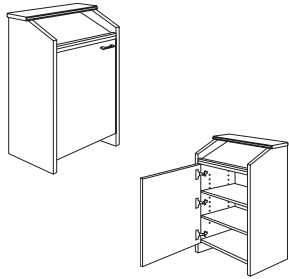

- two adjustable shelves
- four concealed, locking casters
- non-locking doors
- standard door is hinged on left
- round grommet in bottom panel
- notches in adjustable shelves allow wires to pass through

Visual Board	3½	48	48	125	8	BR4848VB	\$3,132
--------------	----	----	----	-----	---	----------	---------

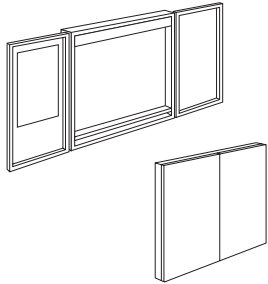

- corkboard on right and left doors; paper pad on left only
- marker board in center
- four markers and eraser included
- locking not available

To Order, Specify:

- ❶ Model Number
- ❷ Wood Species
- ❸ Finish Color
- ❹ Edge Profile
- ❺ Power and Data Options (see page 322)
- ❻ Other Product Options

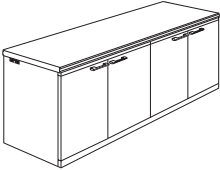
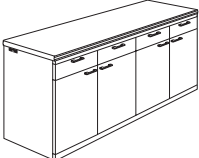
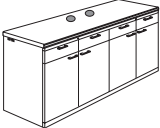
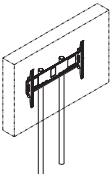
Description	D	W	H	CTN WT	CU FT	① Model	List Price
Four Door Credenza  <ul style="list-style-type: none"> adjustable shelves locking doors available, specify and add \$210 list end panel grommets top edge profile on user side 	24	72	30	300	36	BR2472DSC	\$3,692
	24	66	30	280	33	BR2466DSC	\$3,495
Buffet Credenza  <ul style="list-style-type: none"> four door credenza four box drawers above doors locking not available adjustable shelf in storage cabinet end panel grommets top edge profile on user side 	24	72	36	320	43	BR2472BSC	\$4,994
Buffet Credenza - Flat Screen Support  <ul style="list-style-type: none"> four door credenza four box drawers above doors locking not available adjustable shelf in storage cabinet end panel grommets top edge profile on user side flat screen mounting grommets in top back panel includes cord exit grommets 	24	72	36	320	43	BR2472BSCT	\$5,366
Flat Screen Mounting Fame  <ul style="list-style-type: none"> round 2" tube frame with cable management to inside of credenza mounting bracket for TV provided (see page 322) available in black (B) or silver (S) TV not included coordinates with BR2472BSCT 	2	14	55	35	4	FSTV	\$1,236

BROADWAY

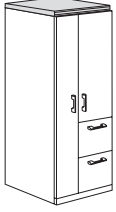
Description	D	W	H	CTN WT	CU FT	① Model	List Price
Modular Cabinet Top 	24	35 5/8	1 1/2	36	3	BR2436MCT For use on: · BR3672SWLF · BR3672W	\$527
	23 7/8	23 3/4	1 1/2	24	2	BR2424MCT For use on: · BR2472SWR · BR2472SWL	\$483
	23 7/8	17 3/4	1 1/2	18	2	BR2418MCT For use on: · BR1872WR · BR1872WL · BR1884WR · BR1884WL	\$367

File/File Lateral Storage Cabinet	24	35 7/8	70 1/2	360	43	BR3672SWLF	\$4,015
--	----	--------	--------	-----	----	-------------------	---------

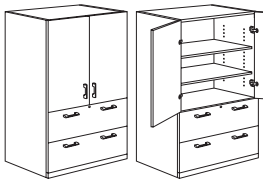

- shelves on top section
- locking lateral files on bottom
- locking doors available, specify and add \$105 list
- optional modular cabinet top; listed above on this page

Wardrobe	24	35 7/8	70 1/2	360	43	BR3672W	\$3,554
-----------------	----	--------	--------	-----	----	----------------	---------

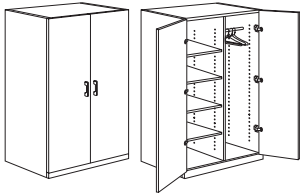

- shelves on left
- one fixed shelf second from bottom; three adjustable shelves
- chrome hanging bar on right
- locking doors available, specify and add \$210 list
- optional modular cabinet top; listed above on this page

Hanging Bar to Shelves Conversion Kit				56	2	BR1824SK	\$634
--	--	--	--	----	---	-----------------	-------

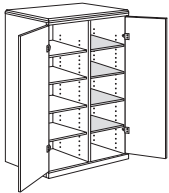

- four shelves
- for 36" wide wardrobe

To Order, Specify:

- ① Model Number
- ② Wood Species
 - A. Work Surface
 - B. Chassis
- ③ Finish Color
 - A Work Surface
 - B. Chassis
- ④ Edge Profile
- ⑤ Power and Data Options (see page 322)
- ⑥ Other Product Options

Description	D	W	H	CTN WT	CU FT	① Model	List Price
Wardrobe	24	18	70 1/2	233	23	BR1872WR	\$2,980
	24	18	70 1/2	233	23	BR1872WL	\$2,980

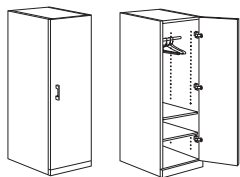

right shown

- chrome hanging bar
- one fixed shelf; one adjustable shelf
- locking doors available, specify and add \$105 list
- optional modular cabinet top; see page 67

Double Height Wardrobe	24	18	82 1/2	265	26	BR1884WR	\$3,279
	24	18	82 1/2	265	26	BR1884WL	\$3,279

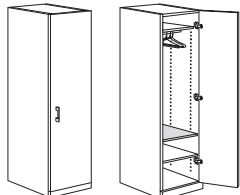

right shown

- chrome hanging bar
- one fixed shelf above hanging bar; one fixed shelf and one adjustable shelf below hanging bar
- locking doors available, specify and add \$105 list
- optional modular cabinet top; see page 67

Shelf Conversion Kit				56	2	BR1624SK	\$501
-----------------------------	--	--	--	----	---	-----------------	--------------

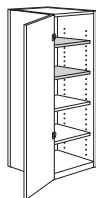

- two shelves
- for 18" wide wardrobe

Storage Wardrobe	24	24	70 1/2	340	29	BR2472SWR	\$3,394
	24	24	70 1/2	340	29	BR2472SWL	\$3,394

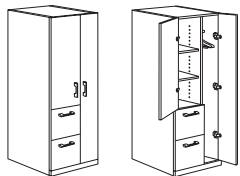

right shown

- chrome hanging bar
- two adjustable shelves
- locking not available
- two letter width file drawers
- optional modular cabinet top; see page 67

TV Storage Overhead	15 7/8	71 3/4	40 1/2	200	39	BR1672TV	\$3,334
	15 7/8	65 3/4	40 1/2	160	36	BR1666TV	\$3,206

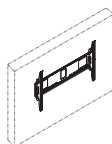
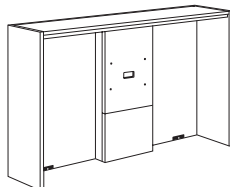

- TV support column for wiring with access door
- two back panel grommets
- grommets in back of support column
- includes Peerless TV mounting kit
- BR1672TV coordinates with BR2472TVDC
- BR1666TV coordinates with BR2466TVDC
- optional cornice overhead trim, listed on the next page
- mounting bracket for TV
- TV not included

Description	D	W	H	CTN WT	CU FT	① Model	List Price
Double Height TV Storage Overhead	15 7/8	71 3/4	52 1/2	200	39	BR1672DTV	\$3,503
	15 7/8	65 3/4	52 1/2	160	36	BR1666DTV	\$3,367

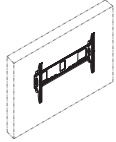
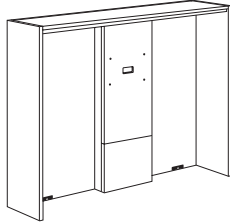

- TV support column for wiring with access door
- two back panel grommets
- grommets in back of support column
- includes Peerless TV mounting kit
- BR1672DTV coordinates with BR2472TVDC
- BR1666DTV coordinates with BR2466TVDC
- optional cornice overhead trim, listed below
- back side of unit intended to go against wall, cabinet should be secured to wall as a safety precaution
- mounting bracket for TV
- TV not included

Four Door Credenza	D	W	H	CTN WT	CU FT	Model	List Price
	24	72	30	300	36	BR2472TVDC	\$3,864
	24	66	30	280	33	BR2466TVDC	\$3,666

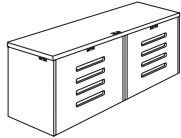
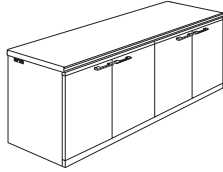

back view

- for use with BR1672DTV, BR1672TV, BR1666DTV and BR1666TV
- grommets on end panels, centered above vents on back panel, and center of top
- locking doors available, specify and add \$210 list
- adjustable shelves
- vent slots centered in back for ventilation of equipment
- top edge profile on user side

Cornice Overhead Trim	D	W	H	CTN WT	CU FT	Model	List Price
	16	72	6	39	2	BR0672CO	\$802
	16	66	6	35	2	BR0666CO	\$793



- two metal tubes - specify metal color option: Black Sandtex, Soft Nickel or Stardust Silver
- veneer arched panel insert - specify finish option
- field installed

To Order, Specify:

- ① Model Number
- ② Wood Species
 - A. Work Surface
 - B. Chassis
- ③ Finish Color
 - A Work Surface
 - B. Chassis
- ④ Edge Profile
- ⑤ Pull (style and color)
- ⑥ Power and Data Options (see page 322)
- ⑦ Other Product Options

Collective Conference Tables Product Information



COLLECTIVE CONFERENCE

Collective Conference Tables Product Information

Exterior Wood Materials

Exterior surfaces are made from the finest selected veneers to achieve clarity and consistency in the Collective Conference product line. To attain a pleasing, symmetrical pattern, all veneers in Collective Conference are book-matched. All exterior solid lumber is matched to coordinate with the veneer.

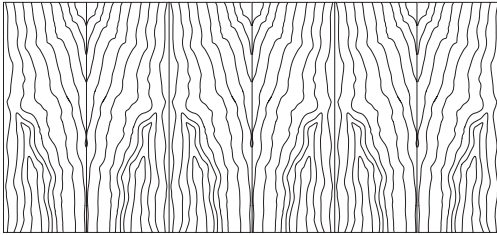

Book Matched Example

Alternating pieces of veneer are flipped over so they face each other like the pages within a book.

Collective Conference is available in flat cut cherry, makore, maple, and walnut veneer. A wide range of wood stains have been formulated to enhance the beauty of the veneer.

Anegre veneer is a premium veneer choice and is quarter cut to have a figure cut (fiddle back) pattern. There is a 15% upcharge applied to the list for Anegre veneer.

Solid painted finishes on MDF are also offered on bases, drawer and door fronts to provide an accent to the Collective Conference product.

Work Surface Construction▲

All tops are 1 3/16" thick with 3-ply construction and trimmed off with matching 1.5mm rims.

Tops are available in wood veneer, applied glass or laminate surfaces. No additional charges for laminate when selecting standard coordinating laminate as listed on the top of the next page.

Chassis Construction

The chassis consists of cherry, makore, maple or walnut book-matched veneer. Mortise and tenon construction. Adjustable leveling glides ensure proper leveling of unit.

Extruded Aluminum Components

Telescopic Feet, Edge Trim Rails, Center Console Components, and Spacers all are made from an alloy aluminum compound, made up of 10% post consumer scrap, 60% post industrial scrap and 30% primary aluminum. The aluminum meets or exceeds the guidelines of USGBC - LEED V2.2. The parts are precisely machined and then processed in a clear anodized finish for a natural aluminum appearance.

Fabricated or Casted Metal Components

Base Trims, Base Pans, Scones and Wire Pans are made up of high grade metals. The metal is laser cut, bent to shape and robotically welded to the exact specifications, polished and powder coated to blend with the anodized aluminum.

Finish - Stain/Colors

We offer a variety of wood stains and paint colors on Collective Conference. Please see the chart below. Samples are available upon request, through our website or by contacting Customer Service. Former finish names are listed in parentheses for reference.

CH1 Cherry	<i>Flat Cut Veneer</i>		
MK2 Makore	<i>Quarter Cut Veneer</i>		
AUT Autumn (<i>Autumn Cherry</i>)		EAR	Earthy
BRL Barley		LGC	Legacy (<i>Legacy Cherry</i>)
BBN Bourbon (<i>Natural Cherry</i>)		PRL	Praline (<i>Vintage Cherry</i>)
BRG Brighton (<i>Brighton Cherry</i>)		SAF	Saffron (<i>Medium Cherry</i>)
CLA Classic (<i>Classic Cherry</i>)			

MA1 Maple	<i>Flat Cut Veneer</i>		
ALE Ale (<i>Natural Maple</i>)		FLX	Flax
BUT Butterscotch		VEN	Venetian (<i>Dark Mahogany</i>)
CIN Cinnamon			

WA1 Walnut	<i>Flat Cut Veneer</i>		
AUB Auburn (<i>Windsor Mahogany</i>)		SIE	Sienna
ESP Espresso		TOF	Toffee
MCH Mocha		TRF	Truffle
NTO Night Owl (<i>Vintage Walnut</i>)			

PNT Paint	<i>MDF Board</i>		
BKD Backdrop		GRV	Greek Villa
BFX Black Fox		NET	Network Gray
BWH Bright White		NWH	Nonchalant White
CGP Cargo Pants		STM	Storm
CHT Chatroom		TRC	Tricorn Black
FRR French Roast			

AN5 Anegre*	<i>Figured Quarter Cut</i>		
CHM Champagne		TPZ	Topaz

* Anegre is a premium veneer, a 15% upcharge to the list of each item will be applied

Protective Top Coat

DuraTex™ offers exceptional hardness along with abrasion and impact resistance, it has been formulated to eliminate hazardous and harmful gases that are normally associated with wood finish.

DuraTex™ Features

Safety - Significantly reduces hazardous formaldehyde emissions which help improve the quality of the indoor air we breathe.

Quality - Developed to be tough and durable with special attention to appearance. The DuraTex™ finish preserves the natural beauty of wood.

Durability - Designed to meet a wide range of demanding performance and environmental standards to withstand even the highest wear and tear.

Collective Conference Tables Product Information

Product Modification

Laminate Tops

Work surface only, no additional upcharge if coordinating wood grain laminate is specified. Contact Customer Service for any other laminate request.

Cherry Finishes	Maple Finishes	Walnut Finishes
<i>Autumn</i>	<i>Ale</i>	<i>Auburn</i>
<i>Barley</i>	<i>Cinnamon</i>	<i>Mocha</i>
<i>Bourbon</i>	<i>Venetian</i>	<i>Night Owl</i>
<i>Brighton</i>		<i>Sienna</i>
<i>Classic</i>		<i>Toffee</i>
<i>Legacy</i>		<i>Truffle</i>
<i>Praline</i>		
<i>Saffron</i>		

Special Finishes

Special finishes can be requested by following the instructions in the general introduction section, page 3. There is a one time charge of \$289 list per order.

Special Top Sizes and Cabinets

Collective Conference offers a large offering of table tops shapes and sizes, along with the Collective Presentation products to create a perfect meeting room. Contact Customer Service if you are having trouble finding the right units to complete the desired configuration. Special sizes and cabinet variations need to be approved by JSI engineering.

Collective Conference Tables Product Information

Top Edge Profiles

Collective Conference offer two edges profiles, along with optional details.

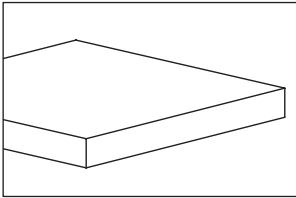

Straight Edge - Veneer

Standard on conference tables and casegoods products.

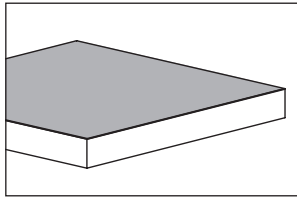

Straight Edge - Laminate

Straight edge with laminate surface available for conference tables and casegood products. See page 73 for standard wood grain laminate.

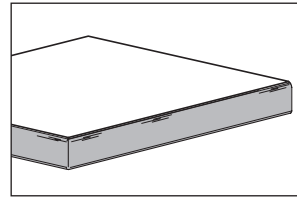

Aluminum Trim Edge Detail

Aluminum trim edge available only on veneer and laminate rectangular shape conference tops. The trim edge is finished in clear anodized finish.

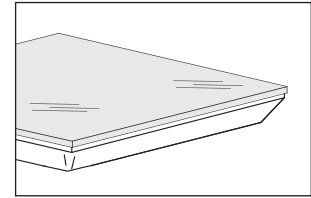

Thin Profile Edge - Glass

Reverse Bevel edge is available with glossy low iron white back painted glass or frosted low iron white back painted glass. Available only on conference table tops.

Base Types

Collective Conference offers five base styles: open cable, closed cable, rectangular, panel and arc end.

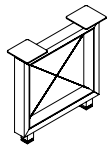

Open Cable Base

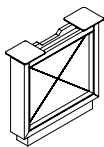

Closed Cable Base

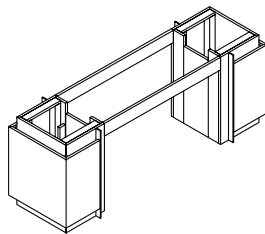

Rectangular Base with Apron Rails

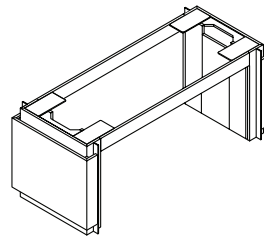

Panel Base with Apron Rails

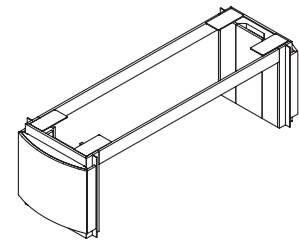

Arc End Base with Apron Rails

Foot/Plinth Style Base

Collective Conference Open Cable Base and Casegoods features an anodized aluminum foot. For a more classic feel, units may be specified with a wood plinth style base. Rectangle, Panel and Arc End Bases are available only with a plinth base.

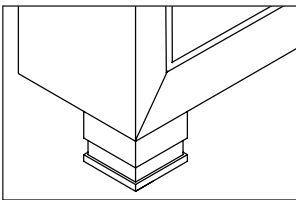

Foot Style

Anodized Aluminum Finish

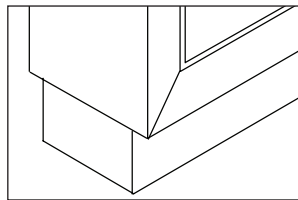

Plinth Base

concealed leveling glide

Foot Leveling Details

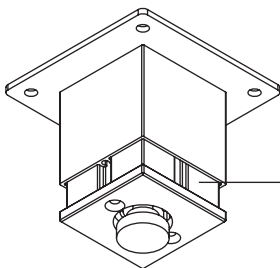

Telescopic cover can slide up to provide access for leveling adjustment

Collective Conference Tables Product Information

Conference Top Shapes and Sizes

Collective Conference offer six top shapes and sizes start at 216" in length. Note size 120" and above are two piece tops.

rectangular	arc end	racetrack	boat	ellipse	view
216" x 60" Seats 18/20 192" x 60" Seats 16/18 168" x 60" Seats 14/16 144" x 60" Seats 10/12 216" x 48" Seats 16/18 192" x 48" Seats 14/16 168" x 48" Seats 12/14 144" x 48" Seats 8/10 120" x 48" Seats 6/8 96" x 48" Seats 6/8 84" x 42" Seats 4/6 72" x 36" Seats 4/6	216" x 60" Seats 16/18 192" x 60" Seats 14/16 168" x 60" Seats 12/14 144" x 60" Seats 10/12 216" x 48" Seats 16/18 192" x 48" Seats 14/16 168" x 48" Seats 12/14 144" x 48" Seats 8/10 120" x 48" Seats 6/8 96" x 48" Seats 6/8 84" x 42" Seats 4/6 72" x 36" Seats 4/6	216" x 60" Seats 18/20 192" x 60" Seats 16/18 168" x 60" Seats 14/16 144" x 60" Seats 10/12 216" x 48" Seats 16/18 192" x 48" Seats 14/16 168" x 48" Seats 12/14 144" x 48" Seats 8/10 120" x 48" Seats 6/8 96" x 48" Seats 6/8 84" x 42" Seats 4/6 72" x 36" Seats 4/6	216" x 60" Seats 16/18 192" x 60" Seats 14/16 168" x 60" Seats 12/14 144" x 48" Seats 8/10 120" x 48" Seats 6/8 96" x 48" Seats 6/8	144" x 60" Seats 10/12 120" x 54" Seats 8/10 96" x 48" Seats 6/8	168" x 60" Seats 12/14 144" x 60" Seats 10/12 120" x 60" Seats 9/10 96" x 60" Seats 7/8 <i>This shape top is only available with bases</i>

Open Cable Bases

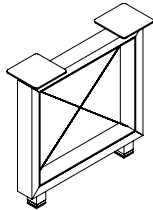

The open cable base features a 1³/₁₆" X-shaped stainless steel cable accent. Open cable bases provide no wire management compartment. The outer frame is wood with a metal inner frame in silver powder coat. Telescopic feet provide 1¹/₂" leveling adjustment.

Configured tables with cable bases in this price lists include support rails for the top.

When specifying cable bases and tops separately, support rails may need to be included. Call Customer Service for more information.

Closed Cable Bases

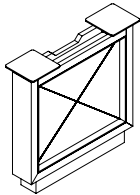

Outside Base
side 1 (approach)

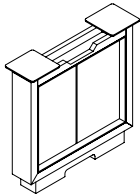

side 2

Closed cable bases include a hinged door compartment and plinth base for wire management.

The outside closed cable base features a visible 1³/₁₆" X-shaped stainless steel cable accent on the side opposite the hinge door. Wires pass through an opening above hinged doors. The base is wood with a metal silver powder coated inner frame.

The middle closed cable base features a wood panel on the side opposite the side hinged door. Wires pass through an opening at the top of both sides.

Configured tables with cable bases in this price lists include support rails for the top.

When specifying cable bases and tops separately, support rails may need to be included. Call Customer Service for more information.

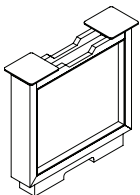

Middle Base
side 1

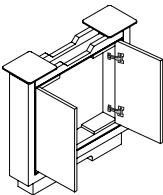

side 2

Collective Conference Tables Product Information

Panel Bases

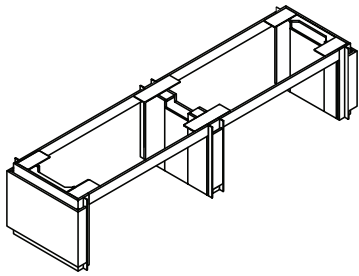

The panel base features slim wood pedestals surrounded by a wood accent. Each pedestal has a hinged door for wire management access and features a silver powder coat metal fin detail.

The panel base is standard with rectilinear end bases. Arc end bases may be specified as an option.

Arc End Bases

(an option to the panel base)

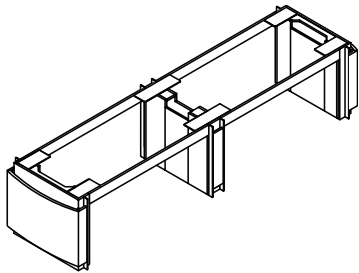

Rectangular Bases

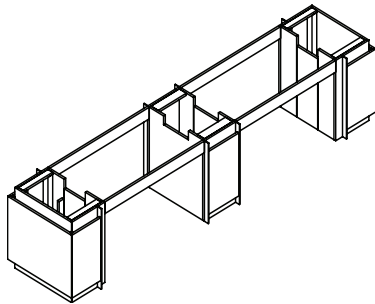

The rectangular base features wide wood pedestals surrounded by a wood accent. Each pedestal has a hinged door for wire management access, an ample storage compartment, and features a silver powder coat metal fin detail.

Collective Conference Tables Product Information

Open Cable Base

The open cable base is available in veneer only.

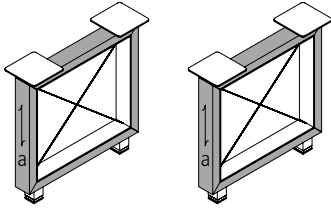

Open Cable Base

a. outer frame - veneer only

Closed Cable Base

There are two material options for the closed cable base. The outer frame and plinth are always veneer. The inner panel/door can be specified in the matching veneer or in a contrasting paint.

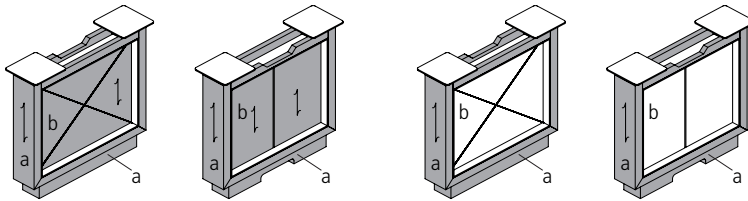

a. outer frame/plinth - veneer
b. inner panel/door - veneer

a. outer frame/plinth - veneer
b. inner panel/door - paint

photo copy or scan, submit with quote/order

Cable Base Ordering Worksheet

Open Cable Base

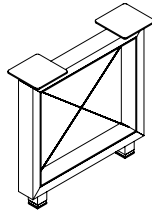

outer frame (a) - veneer only

wood species (choose one)

- cherry
- maple
- makore
- walnut
- anegre (15% upcharge to list)

finish color - outer frame (a) _____
(see page 72 for finish choices)

base
 feet
 plinth (veneer and finish matches outer frame)

metal frame / cable - arctic silver (standard)

Closed Cable Base

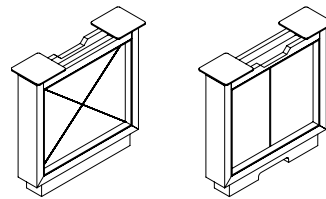

outer frame (a) - veneer only

wood species (choose one)

- cherry
- maple
- makore
- walnut
- anegre (15% upcharge to list)

finish color - outer frame (a) _____
(see page 72 for finish choices)

plinth style base only (veneer and finish matches outer frame)

inner panel/doors (b) - paint or veneer
 veneer (veneer and finish matches outer frame)
 paint
 color - inner panel/doors (b) _____
(see page 72 for paint choices)

metal frame / cable - arctic silver (standard)

Collective Conference Tables Product Information

Panel and Rectangle Base Material Options

There are four finish schemes available for the panel (flat or arc) and rectangle bases.

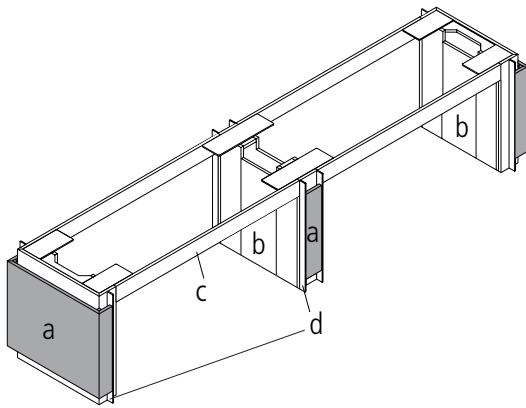

Table Base - Panel Style Parts

- a. accent panel and middle trim
- b. base cabinet
- c. apron
- d. metal trim fin

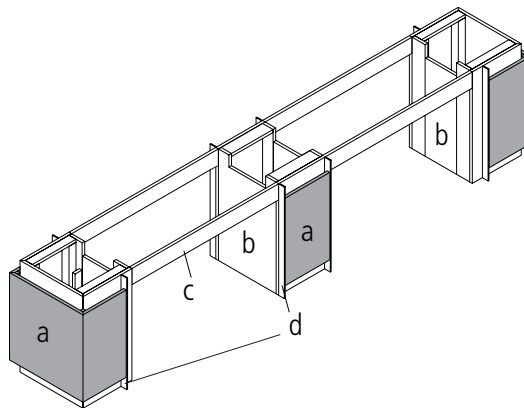
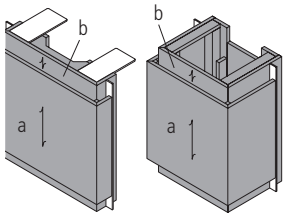

Table Base - Rectangular Style Parts

- a. accent surround and middle trim
- b. base cabinet
- c. apron
- d. metal trim fin

Finish Schemes



Scheme 1 - all veneer

- a. accent panel or surround - veneer
- b. base pedestal - veneer
- c. apron (shown below) - veneer

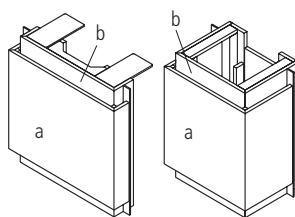

Scheme 2 - all paint

- a. accent panel or surround - paint
- b. base pedestal - paint
- c. apron (shown below) - paint

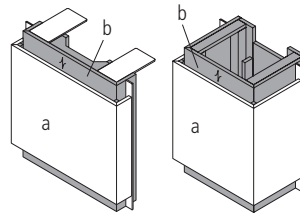

Scheme 3 - veneer and paint

- a. accent panel or surround - paint
- b. base pedestal - veneer
- c. apron (shown below) - veneer

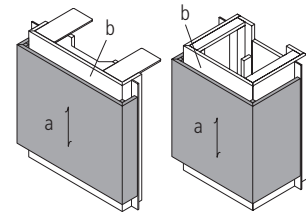

Scheme 4 - paint and veneer

- a. accent panel or surround - veneer
- b. base pedestal - paint
- c. apron (shown below) - paint

COLLECTIVE CONFERENCE

photo copy or scan, submit with quote/order

Table Base Ordering Worksheet

part a - veneer or paint choice

(choose one)

cherry

makore

anegre (15% upcharge to list)

maple

walnut

paint (MDF board)

finish or paint color - see page 72 for finish and paint choices) (part a) _____

part b & c- veneer or paint choice

(choose one)

cherry

makore

anegre (15% upcharge to list)

maple

walnut

paint (MDF board)

finish or paint color - see page 72 for finish and paint choices) (part b) _____

part d - metal fin trim - arctic silver (standard)

Collective Conference Tables Product Information

Round Meeting Tables and Bases

Collective Conference offers three styles of round meeting tables in several diameter sizes.

Glass Top with Column Disc Base[▲]

Available Tables - 48" dia - 42" dia - 36" dia (seats 3 to 4)

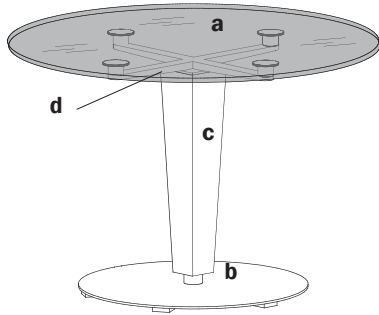

- a Top - ½" glass - frosted glass - underside
- b Base - 26" dia - cast aluminum - arctic silver powder coat
- c Column - veneer
 maple, makore, cherry and walnut - anegre available with an upcharge (choice of one)
- d Spider Armature - glass puck (ultra-violet glue attachment) - arctic silver powder coat

Veneer Top with Column Disc Base[▲]

Available Tables - 48" dia - 42" dia - 36" dia - 30" dia (seats 3 to 4)

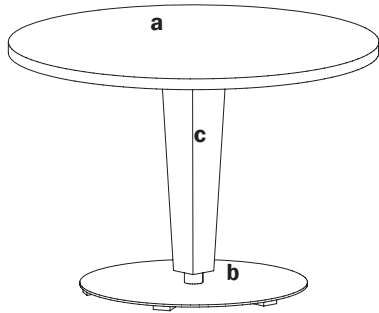

- a Top - 1½" veneer top (laminated surface available see page 73) -
- b Base - 26" dia - cast aluminum - arctic silver powder coat
- c Column - veneer
 maple, makore, cherry and walnut - anegre available with an upcharge (choice of one)

Veneer Top with Cylinder Base[▲]

Available Tables - 48" dia - 42" dia (seats 3 to 4)

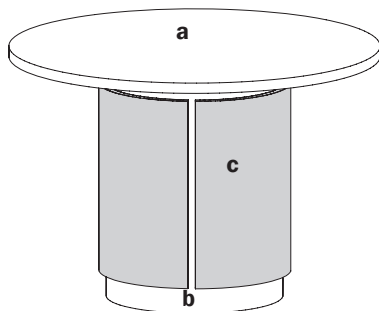

- a Top - 1½" veneer top (laminated surface available see page 73)
- b Cylinder Base - 24" dia - drum style construction
- c Accent Panel - veneer (choice of one)
 maple, makore, cherry and walnut - anegre available with an upcharge
 paint - (see page 73 for color choices)

Collective Conference Tables Product Information

Center Console Overview

The continuous center console supports a variety of functional and aesthetic options. A Collective Conference table with center console includes: the center spine assembly which houses 4", 8", 12" and 16" modules, ordered separately, the understructure of the console, and wire management tray as illustrated below.

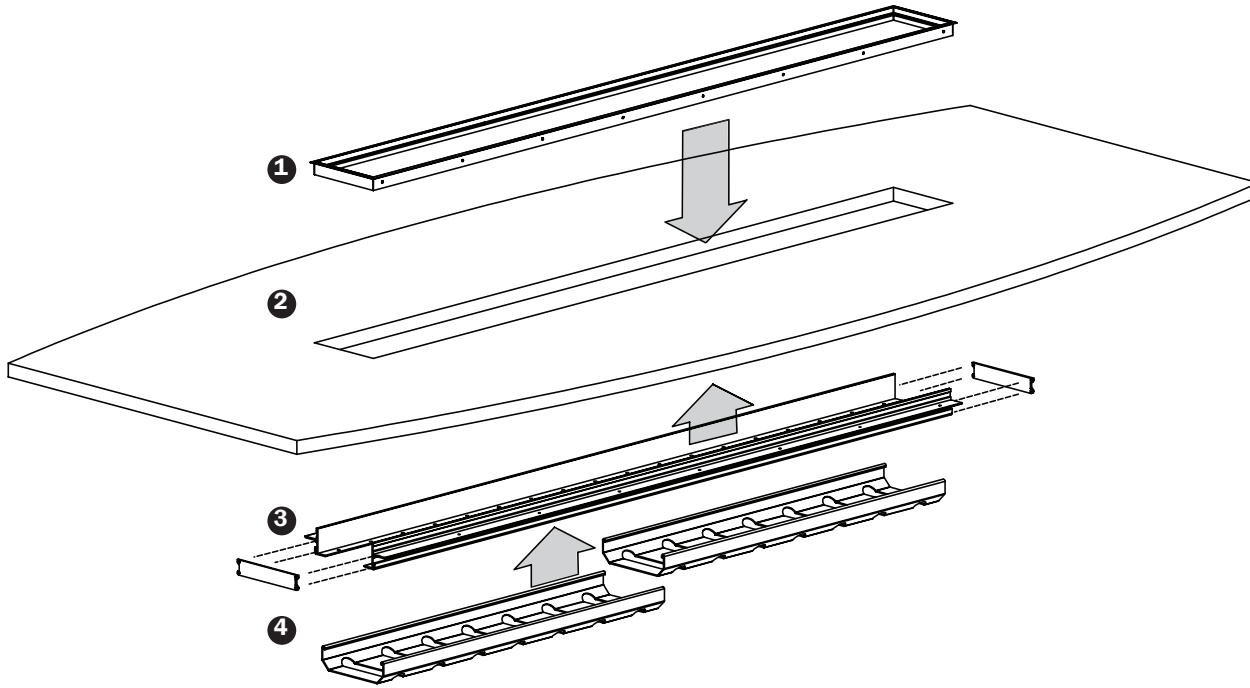

1 Center Spine Bezel Assembly

The center spine bezel assembly accepts the 4", 8", 12" and 16" modules shown on pages 81, 156-157 of the pricing section of this price list.

3 Center Spine Structural Extrusion Assembly

When a table with center console is specified, the center spine structural extrusion assembly is attached to the underside of the table top.

2 Table Top

Tops are available in several shapes including rectangular, racetrack, ellipse, arc end, boat and view. They come with or without center console.

4 Wire Management Tray

When using power/data and lamp modules, the wire management tray channels the cords to the panel or rectangular bases.

Collective Conference Tables Product Information

Center Console Components

Collective Conference is available with a center console for storage, power/data and accessories. The center console is offered in lengths of: 48", 72", 96", 120", 144" & 160". The accessories are offered in 4" increments. When designing your center console the accessories selected must equal the length of your console. The center console is factory installed.

You must specify the order in which you want the accessories to appear using the chart on the bottom of the page.

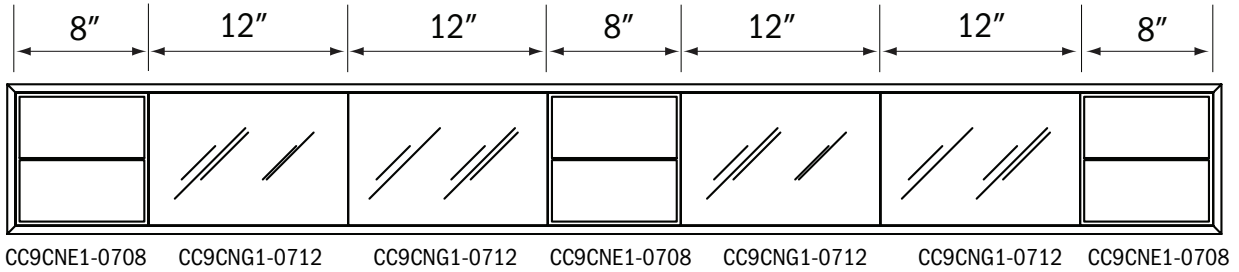

Center Console Accessories

Storage

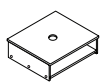

CC9CNS1-0708
8"

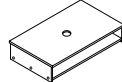

CC9CNS1-0712
12"

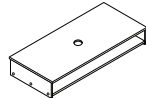

CC9CNS1-0716
16"

Glass Panels

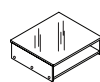

CC9CNG1-0708
8"

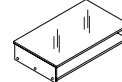

CC9CNG1-0712
12"

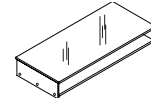

CC9CNG1-0716
16"

Lamp

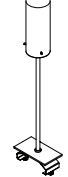

CC9CML1-0704
4"

Vase



CC9CNV1-0704
4"

Accessory Shelf

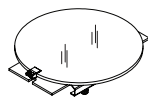

CC9CNA1-1516
16"

Coaster

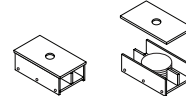

CC9CNC1-0704
4"

Power Data Module

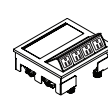

CC9CNE1-0708
8"

photo copy or scan, submit with quote/order

Center Console Worksheet - Order Sheet

A Use the following chart to determine the console length.

Table Length	Console Length
216"	160"
192"	144"
168"	120"
144"	96"
120"	72"
96"	48"

B List out the order in which you want the accessories to appear in the console.

Console Length _____

Item	Length	Item	Length
1. _____	_____	11. _____	_____
2. _____	_____	12. _____	_____
3. _____	_____	13. _____	_____
4. _____	_____	14. _____	_____
5. _____	_____	15. _____	_____
6. _____	_____	16. _____	_____
7. _____	_____	17. _____	_____
8. _____	_____	18. _____	_____
9. _____	_____	19. _____	_____
10. _____	_____	20. _____	_____

*Total length of accessory items must equal total length of console. _____

Collective Conference Tables Product Information

Finish and Product Reference Codes

Select Code

Select	Code
Veneer	
Cherry Flat Cut	CH1
Makore Quarter Cut	MK2
Maple Flat Cut	MA1
Walnut Flat Cut	WA1
Anegre <i>(add 15% to list)</i>	AN5

Finish

Cherry/Makore Finishes	
Autumn	AUT
Barley	BRL
Bourbon	BBN
Brighton	BRG
Classic	CLA
Earthy	EAR
Legacy	LGC
Praline	PRL
Saffron	SAF
Maple Finishes	
Ale	ALE
Butterscotch	BUT
Cinnamon	CIN
Flax	FLX
Venetian	VEN

Select Code

Walnut Finishes	
Auburn	AUB
Espresso	ESP
Mocha	MCH
Night Owl	NTO
Sienna	SIE
Toffee	TOF
Truffle	TRF

Anegre Finishes

Champagne	CHM
Topaz	TPZ

Paint Finishes

Backdrop	BKD
Black Fox	BFX
Bright White	BWH
Cargo Pants	CGP
Chatroom	CHT
French Roast	FRR
Greek Villa	GRV
Network Gray	NET
Nonchalant White	NWH
Storm	STM
Tricorn Black	TRC

Select Code

Laminate Coordinates

Cherry Wood Grain Patterns	
Autumn	AUT
Barley	BRL
Bourbon	BBN
Brighton	BRG
Classic	CLA
Legacy	LGC
Praline	PRL
Saffron	SAF

Maple Wood Grain Patterns

Ale	ALE
Cinnamon	CIN
Venetian	VEN

Walnut Wood Grain Patterns

Auburn	AUB
Mocha	MCH
Night Owl	NTO
Sienna	SIE
Toffee	TOF
Truffle	TRF

Metal Finish

Arctic Silver	ASL
Anodized Clear Aluminum	AAL

COLLECTIVE CONFERENCE

Order Check List:

Specify:

- 1. Model Number
- 2. Finish Scheme/Color (see pages 77 & 78)
- 3. Wood Species - cherry - makore - maple - walnut - anegre (15% upcharge to list applies)
- 4. Top Options - standard veneer - laminate surface (see page 74) - glass
- 5. Aluminum Trim (rectangle tops only) - **if applicable**
- 6. Console Insert Accessories - **if applicable - order items separately**
- 7. Other Product Options
- 8. Power and Data Accessories (*drawing showing location and orientation must accompany order*)
- 9. Side Mark Information (*i.e. room number, East Conference Room*)
- 10. Shipping Address (*contact name and phone number*)
- 11. Special Delivery Instructions (*i.e. call before delivery, deliver to job site*)

Collective Conference Tables Product Information

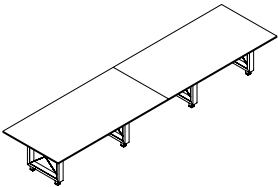
Description	① Model	D	L	H	Seat Capacity	Top Pieces	Bases Required	CTN WT	CU FT	List Price
Rectangular Table with Open Cable Base 	CC8JRX1-48192	48	192	29	14	2	4	561	32	\$20,843
	<ul style="list-style-type: none"> · short grain veneer direction · base (4) CC8NC01-0427 · telescopic feet are anodized aluminum · telescopic feet provide 1 1/2" leveling · top is 1 1/4" thick and in two sections · laminate worksurface, no charge if standard laminate is selected · glass worksurface with reverse bevel edge, (see page 74) call for quote · aluminum edge available on veneer and laminate tops, specify and add \$4,137 list 									

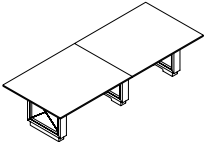
Rectangular Table with Open Cable Base 	CC8JRX1-48168	48	168	29	12	2	3	460	26	\$16,379
	CC8JRX1-48144	48	144	29	8	2	3	421	24	\$15,149
	CC8JRX1-48120	48	120	29	6	2	3	381	21	\$14,156
<ul style="list-style-type: none"> · short grain veneer direction · base (3) CC8NC01-0427 · telescopic feet are anodized aluminum · telescopic feet provide 1 1/2" leveling · top is 1 1/4" thick and in two sections · laminate worksurface, no charge if standard laminate is selected · glass worksurface with reverse bevel edge, (see page 74) call for quote · aluminum edge available on veneer and laminate tops, specify and add \$3,725 list for CC8JRX1-48168, \$3,310 list for CC8JRX1-48144 and \$2,897 list for CC8JRX1-48120 										

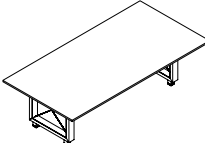
Rectangular Table with Open Cable Base 	CC8JRX1-4896	48	96	29	6	1	2	281	16	\$9,699
	<ul style="list-style-type: none"> · long grain veneer direction · base (2) CC8NC01-0427 · telescopic feet are anodized aluminum · telescopic feet provide 1 1/2" leveling · top is 1 1/4" thick · laminate worksurface, no charge if standard laminate is selected · glass worksurface with reverse bevel edge, (see page 74) call for quote · aluminum edge available on veneer and laminate tops, specify and add \$2,483 list 									

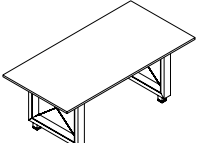
Rectangular Table with Open Cable Base 	CC8JRX1-4284	42	84	29	4	1	2	219	14	\$7,888
	CC8JRX1-3672	36 [▲]	72	29	4	1	2	189	12	\$7,294
<ul style="list-style-type: none"> · long grain veneer direction · base (2) CC8NC01-0423 · telescopic feet are anodized aluminum · telescopic feet provide 1 1/2" leveling · top is 1 1/4" thick · laminate worksurface, no charge if standard laminate is selected · glass worksurface with reverse bevel edge, (see page 74) call for quote · aluminum edge available on veneer and laminate tops, specify and add \$2,172 list for CC8JRX1-4284, \$1,863 list for CC8JRX1-3672 										

COLLECTIVE CONFERENCE

Description	① Model	D	L	H	Seat Capacity	Top Pieces	Bases Required	CTN WT	CU FT	List Price
Arc End Table with Open Cable Base	CC8JAX1-48192	48	192	29	14	2	4	561	32	\$21,281

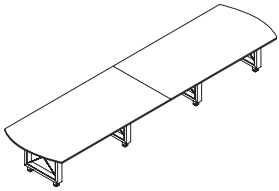

- short grain veneer direction
- base (4) CC8NC01-0427
- telescopic feet are anodized aluminum
- telescopic feet provide 1 1/2" leveling
- top is 1 1/4" thick and in two sections
- laminate worksurface, no charge if standard laminate is selected
- glass worksurface with reverse bevel edge, (see page 74) call for quote

Arc End Table with Open Cable Base	CC8JAX1-48168	48	168	29	12	2	3	460	26	\$16,754
	CC8JAX1-48144	48	144	29	8	2	3	421	24	\$15,462
	CC8JAX1-48120	48	120	29	6	2	3	381	21	\$14,411

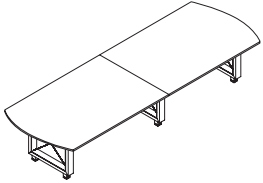

- short grain veneer direction
- base (3) CC8NC01-0427
- telescopic feet are anodized aluminum
- telescopic feet provide 1 1/2" leveling
- top is 1 1/4" thick and in two sections
- laminate worksurface, no charge if standard laminate is selected
- glass worksurface with reverse bevel edge, (see page 74) call for quote

Arc End Table with Open Cable Base	CC8JAX1-4896	48	96	29	6	1	2	281	16	\$9,883
------------------------------------	---------------------	----	----	----	---	---	---	-----	----	---------

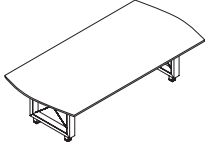

- long grain veneer direction
- base (2) CC8NC01-0427
- telescopic feet are anodized aluminum
- telescopic feet provide 1 1/2" leveling
- top is 1 1/4" thick
- laminate worksurface, no charge if standard laminate is selected
- glass worksurface with reverse bevel edge, (see page 74) call for quote

Arc End Table with Open Cable Base	CC8JAX1-4284	42	84	29	4	1	2	219	14	\$8,022
	CC8JAX1-3672	36	72	29	4	1	2	189	12	\$7,390

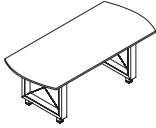

- long grain veneer direction
- base (2) CC8NC01-0423
- telescopic feet are anodized aluminum
- telescopic feet provide 1 1/2" leveling
- top is 1 1/4" thick
- laminate worksurface, no charge if standard laminate is selected
- glass worksurface with reverse bevel edge, (see page 74) call for quote



To Order, Specify:

Rectangular Table with Open Cable Base

- ① Model Number
- ② Wood Species
- ③ Finish Color
- ④ Worksurface Option
 - A. Veneer
 - B. Laminate
 - C. White Back Painted Glass - Glossy
 - D. White Back Painted Glass - Frosted (see page 74)
- ⑤ Edge Detail
 - A. Straight
 - B. Aluminum Trim
- ⑥ Power and Data Options (see page 322)
- ⑦ Other Product Options

Arc End Table with Open Cable Base

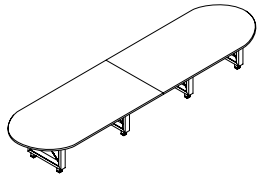
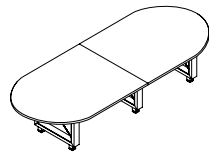
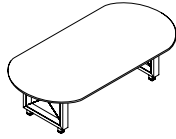
- ① Model Number
- ② Wood Species
- ③ Finish Color
- ④ Worksurface Option
 - A. Veneer
 - B. Laminate
 - C. Back Painted Glass - Shiny
 - D. Back Painted Glass - Matte (see page 74)
- ⑤ Power and Data Options (see page 322)
- ⑦ Other Product Options

Description	① Model	D	L	H	Seat Capacity	Top Pieces	Bases Required	CTN WT	CU FT	List Price
Racetrack Table with Open Cable Base 	CC8J0X1-48192	48	192	29	14	2	4	535	42	\$21,427
	<ul style="list-style-type: none"> · short grain veneer direction · base (4) CC8NC01-0427 · telescopic feet are anodized aluminum · telescopic feet provide 1 1/2" leveling · top is 1 1/4" thick and in two sections · laminate worksurface, no charge if standard laminate is selected · glass worksurface with reverse bevel edge, (see page 74) call for quote 									
Racetrack Table with Open Cable Base 	CC8J0X1-48168	48	168	29	12	2	3	453	26	\$16,879
	CC8J0X1-48144	48	144	29	8	2	3	405	24	\$15,566
	CC8J0X1-48120	48	120	29	6	2	3	365	21	\$14,498
<ul style="list-style-type: none"> · short grain veneer direction · base (3) CC8NC01-0427 · telescopic feet are anodized aluminum · telescopic feet provide 1 1/2" leveling · top is 1 1/4" thick and in two sections · laminate worksurface, no charge if standard laminate is selected · glass worksurface with reverse bevel edge, (see page 74) call for quote 										
Racetrack Table with Open Cable Base 	CC8J0X1-4896	48	96	29	6	1	2	256	16	\$9,945
	<ul style="list-style-type: none"> · long grain veneer direction · base (2) CC8NC01-0427 · telescopic feet are anodized aluminum · telescopic feet provide 1 1/2" leveling · top is 1 1/4" thick · laminate worksurface, no charge if standard laminate is selected · glass worksurface with reverse bevel edge, (see page 74) call for quote 									
Racetrack Table with Open Cable Base 	CC8J0X1-4284	42	84	29	4	1	2	206	14	\$8,068
	CC8J0X1-3672	36	72	29	4	1	2	180	12	\$7,423
<ul style="list-style-type: none"> · long grain veneer direction · base (2) CC8NC01-0423 · telescopic feet are anodized aluminum · telescopic feet provide 1 1/2" leveling · top is 1 1/4" thick · laminate worksurface, no charge if standard laminate is selected · glass worksurface with reverse bevel edge, (see page 74) call for quote 										

COLLECTIVE CONFERENCE

Description	① Model	D	L	H	Seat Capacity	Top Pieces	Bases Required	CTN WT	CU FT	List Price
Boat Shape Table with Open Cable Base	CC8JBX1-48144	48	144	29	8	2	3	393	24	\$16,839
	CC8JBX1-48120	48	120	29	6	2	3	358	21	\$15,536

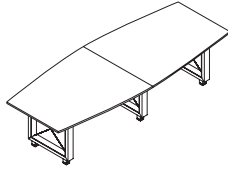

- short grain veneer direction
- base (3) CC8NC01-0427
- telescopic feet are anodized aluminum
- telescopic feet provide 1 1/2" leveling
- top is 1 1/4" thick
- laminate worksurface, no charge if standard laminate is selected
- glass worksurface with reverse bevel edge, (see page 74) call for quote

Boat Shape Table with Open Cable Base	CC8JBX1-4896	48	96	29	6	1	2	262	16	\$10,725
---------------------------------------	--------------	----	----	----	---	---	---	-----	----	----------

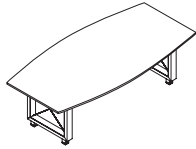

- long grain veneer direction
- base (2) CC8NC01-0427
- telescopic feet are anodized aluminum
- telescopic feet provide 1 1/2" leveling
- top is 1 1/4" thick
- laminate worksurface, no charge if standard laminate is selected
- glass worksurface with reverse bevel edge, (see page 74) call for quote

Ellipse Table with Open Cable Base	CC8JEX1-54120	54	120	29	8	2	3	354	23	\$16,065
------------------------------------	---------------	----	-----	----	---	---	---	-----	----	----------

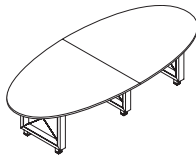

- long grain veneer direction
- base (3) CC8NC01-0427
- telescopic feet are anodized aluminum
- telescopic feet provide 1 1/2" leveling
- top is 1 1/4" thick and in two sections
- laminate worksurface, no charge if standard laminate is selected
- glass worksurface with reverse bevel edge, (see page 74) call for quote

Ellipse Table with Open Cable Base	CC8JEX1-4896	48	96	29	6	1	2	244	16	\$11,087
------------------------------------	--------------	----	----	----	---	---	---	-----	----	----------



- long grain veneer direction
- base (2) CC8NC01-0423
- telescopic feet are anodized aluminum
- telescopic feet provide 1 1/2" leveling
- top is 1 1/4" thick
- laminate worksurface, no charge if standard laminate is selected
- glass worksurface with reverse bevel edge, (see page 74) call for quote

To Order, Specify:

Racetrack Table with Open Cable Base

- ① Model Number
- ② Wood Species
- ③ Finish Color
- ④ Worksurface Option
 - A. Veneer
 - B. Laminate
 - C. White Back Painted Glass - Glossy
 - D. White Back Painted Glass - Frosted (see page 74)
- ⑤ Power and Data Options (see page 322)
- ⑥ Other Product Options

Boat Shape or Ellipse Table with Open Cable Base

- ① Model Number
- ② Wood Species
- ③ Finish Color
- ④ Worksurface Option
 - A. Veneer
 - B. Laminate
 - C. Back Painted Glass - Shiny
 - D. Back Painted Glass - Matte (see page 74)
- ⑤ Power and Data Options (see page 322)
- ⑥ Other Product Options

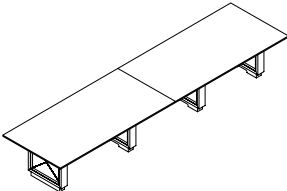
Description	① Model	D	L	H	Seat Capacity	Top Pieces	Bases Required	CTN WT	CU FT	List Price
Rectangular Table with Closed Cable Base 	CC8JRY1-48192	48	192	29	14	2	4	601	32	\$18,094
	<ul style="list-style-type: none"> · short grain veneer direction · bases (2) CC8NCC1-0527 outside and (2) CC8NCM1-0527 middle · plinth base · top is 1 1/4" thick and in two sections · laminate worksurface, no charge if standard laminate is selected · glass worksurface with reverse bevel edge, (see page 74) call for quote · aluminum edge available on veneer and laminate tops, specify and add \$4,137 list 									

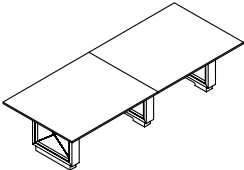
Rectangular Table with Closed Cable Base 	CC8JRY1-48168	48	168	29	12	2	3	490	26	\$15,335
	CC8JRY1-48144	48	144	29	8	2	3	451	24	\$14,105
	CC8JRY1-48120	48	120	29	6	2	3	411	21	\$13,113
<ul style="list-style-type: none"> · short grain veneer direction · bases (2) CC8NCC1-0527 outside and (1) CC8NCM1-0527 middle · plinth base · top is 1 1/4" thick and in two sections · laminate worksurface, no charge if standard laminate is selected · glass worksurface with reverse bevel edge, (see page 74) call for quote · aluminum edge available on veneer and laminate tops, specify and add \$3,725 list for CC8JRY1-48168, \$3,310 list for CC8JRY1-48144 and \$2,897 list for CC8JRY1-48120 										

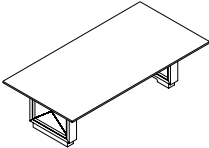
Rectangular Table with Closed Cable Base 	CC8JRY1-4896	48	96	29	6	1	2	301	16	\$10,361
<ul style="list-style-type: none"> · long grain veneer direction · bases (2) CC8NCC1-0527 · plinth base · top is 1 1/4" thick · laminate worksurface, no charge if standard laminate is selected · glass worksurface with reverse bevel edge, (see page 74) call for quote · aluminum edge available on veneer and laminate tops, specify and add \$2,483 list 										

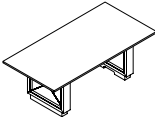
Rectangular Table with Closed Cable Base 	CC8JRY1-4284	42	84	29	4	1	2	245	14	\$8,736
	CC8JRY1-3672	36	72	29	4	1	2	213	12	\$8,140
<ul style="list-style-type: none"> · long grain veneer direction · bases (2) CC8NCC1-0523 · plinth base · top is 1 1/4" thick · laminate worksurface, no charge if standard laminate is selected · glass worksurface with reverse bevel edge, (see page 74) call for quote · aluminum edge available on veneer and laminate tops, specify and add \$2,172 list for CC8JRY1-4284, \$1,863 list for CC8JRY1-3672 										

COLLECTIVE CONFERENCE

Description	① Model	D	L	H	Seat Capacity	Top Pieces	Bases Required	CTN WT	CU FT	List Price
-------------	---------	---	---	---	---------------	------------	----------------	--------	-------	------------

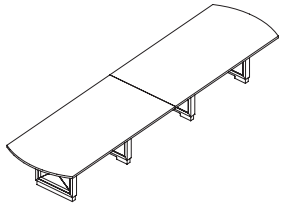
Arc End Table with Closed Cable Base 	CC8JAY1-48192	48	192	29	14	2	4	601	32	\$18,533
	<ul style="list-style-type: none"> • short grain veneer direction • bases (2) CC8NCC1-0527 outside and (2) CC8NCM1-0527 middle • plinth base • top is 1 1/4" thick • laminate worksurface, no charge if standard laminate is selected • glass worksurface with reverse bevel edge, (see page 74) call for quote 									

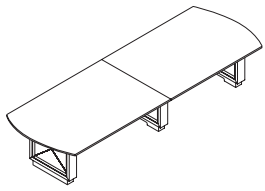
Arc End Table with Closed Cable Base 	CC8JAY1-48168	48	168	29	12	2	3	490	26	\$15,711
	CC8JAY1-48144	48	144	29	8	2	3	451	24	\$14,417
	CC8JAY1-48120	48	120	29	6	2	3	411	21	\$13,368
<ul style="list-style-type: none"> • short grain veneer direction • bases (2) CC8NCC1-0527 outside and (1) CC8NCM1-0527 middle • plinth base • top is 1 1/4" thick • laminate worksurface, no charge if standard laminate is selected • glass worksurface with reverse bevel edge, (see page 74) call for quote 										

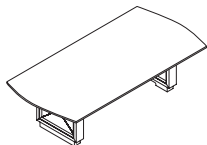
Arc End Table with Closed Cable Base 	CC8JAY1-4896	48	96	29	6	1	2	301	16	\$10,546
<ul style="list-style-type: none"> • long grain veneer direction • bases (2) CC8NCC1-0527 • plinth base • top is 1 1/4" thick • laminate worksurface, no charge if standard laminate is selected • glass worksurface with reverse bevel edge, (see page 74) call for quote 										

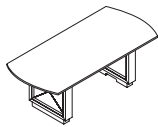
Arc End Table with Closed Cable Base 	CC8JAY1-4284	42	84	29	4	1	2	245	14	\$8,872
	CC8JAY1-3672	36	72	29	4	1	2	213	12	\$8,239
<ul style="list-style-type: none"> • long grain veneer direction • bases (2) CC8NCC1-0523 • plinth base • top is 1 1/4" thick • laminate worksurface, no charge if standard laminate is selected • glass worksurface with reverse bevel edge, (see page 74) call for quote 										

To Order, Specify:

Rectangular Table with Closed Cable Base

- ① Model Number
- ② Wood Species
- ③ Finish Color
- ④ Worksurface Option
 - A. Veneer
 - B. Laminate
 - C. White Back Painted Glass - Glossy
 - D. White Back Painted Glass - Frosted (see page 74)
- ⑤ Edge Detail
 - A. Straight
 - B. Aluminum Trim
- ⑥ Power and Data Options (see page 322)
- ⑦ Other Product Options

Arc End Table with Closed Cable Base

- ① Model Number
- ② Wood Species
- ③ Finish Color
- ④ Worksurface Option
 - A. Veneer
 - B. Laminate
 - C. Back Painted Glass - Shiny
 - D. Back Painted Glass - Matte (see page 74)
- ⑤ Power and Data Options (see page 322)
- ⑥ Other Product Options

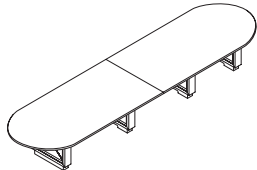
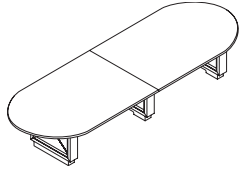
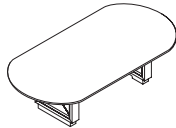
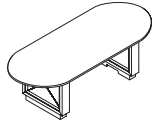
Description	① Model	D	L	H	Seat Capacity	Top Pieces	Bases Required	CTN WT	CU FT	List Price
Racetrack Table with Closed Cable Base 	CC8JOY1-48192	48	192	29	14	2	4	585	32	\$18,678
	<ul style="list-style-type: none"> · short grain veneer direction · bases (2) CC8NCC1-0527 outside and (2) CC8NCM1-0527 middle · plinth base · top is 1 ¼" thick and in two sections · laminate worksurface, no charge if standard laminate is selected · glass worksurface with reverse bevel edge, (see page 74) call for quote 									
Racetrack Table with Closed Cable Base 	CC8JOY1-48168	48	168	29	12	2	3	483	26	\$15,837
	CC8JOY1-48144	48	144	29	8	2	3	435	24	\$14,523
	CC8JOY1-48120	48	120	29	6	2	3	395	21	\$13,453
<ul style="list-style-type: none"> · short grain veneer direction · bases (2) CC8NCC1-0527 outside and (1) CC8NCM1-0527 middle · plinth base · top is 1 ¼" thick and in two sections · laminate worksurface, no charge if standard laminate is selected · glass worksurface with reverse bevel edge, (see page 74) call for quote 										
Racetrack Table with Closed Cable Base 	CC8JOY1-4896	48	96	29	6	1	2	276	16	\$10,607
	<ul style="list-style-type: none"> · long grain veneer direction · bases (2) CC8NCC1-0527 · plinth base · top is 1 ¼" thick · laminate worksurface, no charge if standard laminate is selected · glass worksurface with reverse bevel edge, (see page 74) call for quote 									
Racetrack Table with Closed Cable Base 	CC8JOY1-4284	42	84	29	4	1	2	232	14	\$8,916
	CC8JOY1-3672	36	72	29	4	1	2	213	12	\$8,271
<ul style="list-style-type: none"> · long grain veneer direction · bases (2) CC8NCC1-0523 · plinth base · top is 1 ¼" thick · laminate worksurface, no charge if standard laminate is selected · glass worksurface with reverse bevel edge, (see page 74) call for quote 										

COLLECTIVE CONFERENCE

Description	① Model	D	L	H	Seat Capacity	Top Pieces	Bases Required	CTN WT	CU FT	List Price
Boat Shape Table with Closed Cable Base	CC8JBY1-48144	48	144	29	8	2	3	423	24	\$15,796
	CC8JBY1-48120	48	120	29	6	2	3	388	21	\$14,492
Boat Shape Table with Closed Cable Base	CC8JBY1-4896	48	96	29	6	1	2	282	16	\$11,387
	CC8JEY1-54120	54	120	29	8	2	3	384	23	\$15,021
Ellipse Table with Closed Cable Base	CC8JEY1-4896	48	96	29	6	1	2	264	16	\$11,750

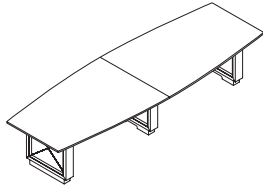

- short grain veneer direction
- bases (2) CC8NCC1-0527 outside and (1) CC8NCM1-0527 middle
- plinth base
- top is 1 1/4" thick and in two sections
- laminate worksurface, no charge if standard laminate is selected
- glass worksurface with reverse bevel edge, (see page 74) call for quote

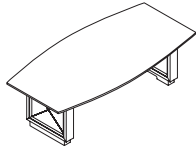

- long grain veneer direction
- bases (2) CC8NCC1-0527
- plinth base
- top is 1 1/4" thick
- laminate worksurface, no charge if standard laminate is selected
- glass worksurface with reverse bevel edge, (see page 74) call for quote

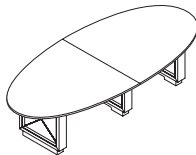

- short grain veneer direction
- bases (2) CC8NCC1-0527 outside and (1) CC8NCM1-0527 middle
- plinth base
- top is 1 1/4" thick and in two sections
- laminate worksurface, no charge if standard laminate is selected
- glass worksurface with reverse bevel edge, (see page 74) call for quote

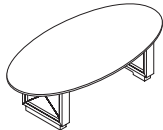

- long grain veneer direction
- base (2) CC8NCC1-0527
- plinth base
- top is 1 1/4" thick
- laminate worksurface, no charge if standard laminate is selected
- glass worksurface with reverse bevel edge, (see page 74) call for quote

To Order, Specify:

- ① Model Number
- ② Wood Species
- ③ Finish Color
- ④ Worksurface Option
 - A. Veneer
 - B. Laminate
 - C. White Back Painted Glass - Glossy
 - D. White Back Painted Glass - Frosted
 (see page 74)
- ⑤ Power and Data Options (see page 322)
- ⑥ Other Product Options

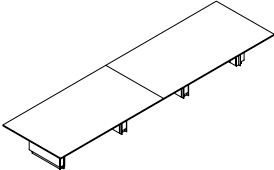
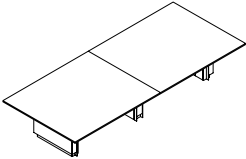
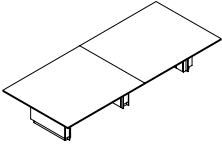
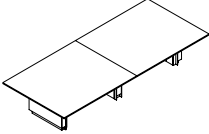
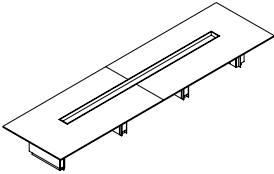
Description	① Model	D	L	H	Seat Capacity	Top Pieces	Bases Required	CTN WT	CU FT	List Price
Rectangular Table with Panel Base 	CC8JRP2-60216	60	216	29	18	2	4	813	47	\$22,860
	<ul style="list-style-type: none"> • short grain veneer direction • base CC8NPC2-32174 • plinth base • top is 1 1/4" thick and in two sections • laminate worksurface, no charge if standard laminate is selected • base front arc panel, add \$464 to list, arc is only outside bases • glass worksurface with reverse bevel edge, (see page 74) call for quote • aluminum edge available on veneer and laminate tops, specify and add \$4,757 list 									
Rectangular Table with Panel Base 	CC8JRP2-60192	60	192	29	16	2	3	682	39	\$17,791
	<ul style="list-style-type: none"> • short grain veneer direction • base CC8NPC2-32156 • plinth base • top is 1 1/4" thick and in two sections • laminate worksurface, no charge if standard laminate is selected • base front arc panel, add \$464 to list, arc is only outside bases • glass worksurface with reverse bevel edge, (see page 74) call for quote • aluminum edge available on veneer and laminate tops, specify and add \$4,345 list 									
Rectangular Table with Panel Base 	CC8JRP2-60168	60	168	29	14	2	3	630	36	\$15,975
	<ul style="list-style-type: none"> • short grain veneer direction • base CC8NPC2-32132 • plinth base • top is 1 1/4" thick and in two sections • laminate worksurface, no charge if standard laminate is selected • base front arc panel, add \$464 to list, arc is only outside bases • glass worksurface with reverse bevel edge, (see page 74) call for quote • aluminum edge available on veneer and laminate tops, specify and add \$3,932 list 									
Rectangular Table with Panel Base 	CC8JRP2-60144	60	144	29	10	2	3	578	33	\$14,528
	<ul style="list-style-type: none"> • short grain veneer direction • base CC8NPC2-32108 • plinth base • top is 1 1/4" thick and in two sections • laminate worksurface, no charge if standard laminate is selected • base front arc panel, add \$464 to list, arc is only outside bases • glass worksurface with reverse bevel edge, (see page 74) call for quote • aluminum edge available on veneer and laminate tops, specify and add \$3,517 list 									
Rectangular Table with Panel Base and Center Console 	CC8JRPM-60216	60	216	29	18	2	4	814	55	\$28,103
	<ul style="list-style-type: none"> • short grain veneer direction • base CC8NPC2-32174 • plinth base • top is 1 1/4" thick and in two sections • anodized aluminum center console 160" long • laminate worksurface, no charge if standard laminate is selected • base front arc panel, add \$464 to list, arc is only outside bases • glass worksurface with reverse bevel edge, (see page 74) call for quote • aluminum edge available on veneer and laminate tops, specify and add \$4,757 list 									

COLLECTIVE CONFERENCE

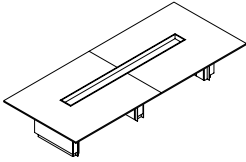
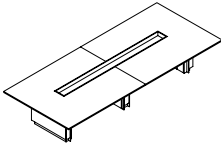
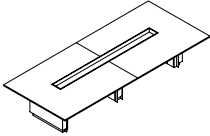
Description	① Model	D	L	H	Seat Capacity	Top Pieces	Bases Required	CTN WT	CU FT	List Price
Rectangular Table with Panel Base and Center Console 	CC8JRP-60192	60	192	29	16	2	3	692	46	\$22,319
	<ul style="list-style-type: none"> • short grain veneer direction • base CC8NPC2-32156 • plinth base • top is 1 1/4" thick and in two sections • anodized aluminum center console 144" long • laminate worksurface, no charge if standard laminate is selected • base front arc panel, add \$464 to list, arc is only outside bases • glass worksurface with reverse bevel edge, (see page 74) call for quote • aluminum edge available on veneer and laminate tops, specify and add \$4,345 list 									
Rectangular Table with Panel Base and Center Console 	CC8JRP-60168	60	168	29	14	2	3	631	42	\$19,789
	<ul style="list-style-type: none"> • short grain veneer direction • base CC8NPC2-32132 • plinth base • top is 1 1/4" thick and in two sections • anodized aluminum center console 120" long • laminate worksurface, no charge if standard laminate is selected • base front arc panel, add \$464 to list, arc is only outside bases • glass worksurface with reverse bevel edge, (see page 74) call for quote • aluminum edge available on veneer and laminate tops, specify and add \$3,932 list 									
Rectangular Table with Panel Base and Center Console 	CC8JRP-60144	60	144	29	10	2	3	578	39	\$17,626
	<ul style="list-style-type: none"> • short grain veneer direction • base CC8NPC2-32108 • plinth base • top is 1 1/4" thick and in two sections • anodized aluminum center console 96" long • laminate worksurface, no charge if standard laminate is selected • base front arc panel, add \$464 to list, arc is only outside bases • glass worksurface with reverse bevel edge, (see page 74) call for quote • aluminum edge available on veneer and laminate tops, specify and add \$3,517 list 									

To Order, Specify:

Rectangular Table

- ① Model Number
- ② Wood Species
- ③ Finish Scheme
 - A. Accent Surround - Veneer or Paint
 - B. Base Pedestal - Veneer or Paint
 (see page 78 - apron follows base pedestal)
- ④ Worksurface Option
 - A. Veneer
 - B. Laminate
 - C. White Back Painted Glass - Glossy
 - D. White Back Painted Glass - Frosted
 (see page 74)
- ⑤ Power and Data Options (see page 322)
- ⑥ Other Product Options

Rectangular Table with Center Console

- ① Model Number
- ② Wood Species
- ③ Finish Scheme
 - A. Accent Surround - Veneer or Paint
 - B. Base Pedestal - Veneer or Paint
 (see page 78 - apron follows base pedestal)
- ④ Worksurface Option
 - A. Veneer
 - B. Laminate
 - C. White Back Painted Glass - Glossy
 - D. White Back Painted Glass - Frosted
 (see page 74)
- ⑤ Power and Data Options (see page 322)
- ⑥ Other Product Option
- ⑦ Center Console Accessories (see pages 156-157 - order separately)

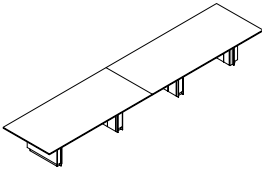
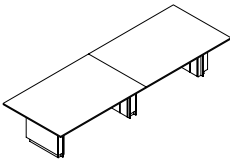
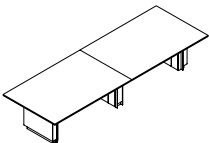
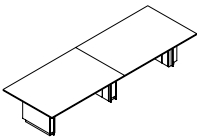
Description	① Model	D	L	H	Seat Capacity	Top Pieces	Bases Required	CTN WT	CU FT	List Price
Rectangular Table with Panel Base 	CC8JRP2-48216	48	216	29	16	2	4	702	38	\$19,413
	<ul style="list-style-type: none"> · short grain veneer direction · base CC8NPC2-27174 · plinth base · top is 1 1/4" thick and in two sections · laminate worksurface, no charge if standard laminate is selected · base front arc panel, add \$464 to list, arc is only outside bases · glass worksurface with reverse bevel edge, (see page 74) call for quote · aluminum edge available on veneer and laminate tops, specify and add \$4,551 list 									
Rectangular Table with Panel Base 	CC8JRP2-48192	48	192	29	14	2	3	581	32	\$14,918
	<ul style="list-style-type: none"> · short grain veneer direction · base CC8NPC2-27156 · plinth base · top is 1 1/4" thick and in two sections · laminate worksurface, no charge if standard laminate is selected · base front arc panel, add \$464 to list, arc is only outside bases · glass worksurface with reverse bevel edge, (see page 74) call for quote · aluminum edge available on veneer and laminate tops, specify and add \$4,137 list 									
Rectangular Table with Panel Base 	CC8JRP2-48168	48	168	29	12	2	3	538	29	\$13,436
	<ul style="list-style-type: none"> · short grain veneer direction · base CC8NPC2-27132 · plinth base · top is 1 1/4" thick and in two sections · laminate worksurface, no charge if standard laminate is selected · base front arc panel, add \$464 to list, arc is only outside bases · glass worksurface with reverse bevel edge, (see page 74) call for quote · aluminum edge available on veneer and laminate tops, specify and add \$3,725 list 									
Rectangular Table with Panel Base 	CC8JRP2-48144	48	144	29	8	2	3	497	27	\$12,305
	<ul style="list-style-type: none"> · short grain veneer direction · base CC8NPC2-27108 · plinth base · top is 1 1/4" thick and in two sections · laminate worksurface, no charge if standard laminate is selected · base front arc panel, add \$464 to list, arc is only outside bases · glass worksurface with reverse bevel edge, (see page 74) call for quote · aluminum edge available on veneer and laminate tops, specify and add \$3,310 list 									

COLLECTIVE CONFERENCE

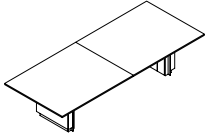
Description	① Model	D	L	H	Seat Capacity	Top Pieces	Bases Required	CTN WT	CU FT	List Price
Rectangular Table with Panel Base 	CC8JRP2-48120	48	120	29	6	2	2	375	20	\$8,000
	<ul style="list-style-type: none"> • short grain veneer direction • base CC8NPC2-2784 • plinth base • top is 1 1/4" thick and in two sections • laminate worksurface, no charge if standard laminate is selected • base front arc panel, add \$464 to list, arc is only outside bases • glass worksurface with reverse bevel edge, (see page 74) call for quote • aluminum edge available, specify and add \$2,897 list 									

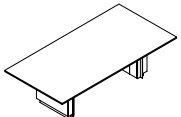
Rectangular Table with Panel Base 	CC8JRP2-4896	48	96	29	6	1	2	334	18	\$6,734
	<ul style="list-style-type: none"> • long grain veneer direction • base CC8NPC2-2760 • plinth base • top is 1 1/4" thick • laminate worksurface, no charge if standard laminate is selected • base front arc panel, add \$464 to list, arc is only outside bases • glass worksurface with reverse bevel edge, (see page 74) call for quote • aluminum edge available, specify and add \$2,483 list 									

To Order, Specify:

- ① Model Number
- ② Wood Species
- ③ Finish Scheme
 - A. Accent Surround - Veneer or Paint
 - B. Base Pedestal - Veneer or Paint
(see page 78 - apron follows base pedestal)
- ④ Edge Detail
 - A. Straight
 - B. Aluminum Trim
- ⑤ Worksurface Option
 - A. Veneer
 - B. Laminate
 - C. White Back Painted Glass - Glossy
 - D. White Back Painted Glass - Frosted
(see page 74)
- ⑥ Power and Data Options (see page 322)
- ⑦ Other Product Options

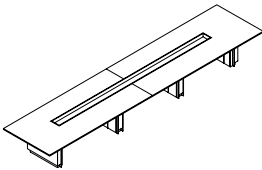
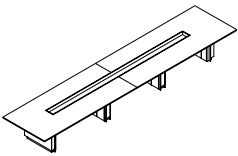
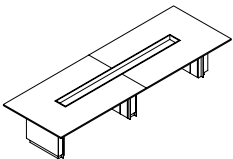
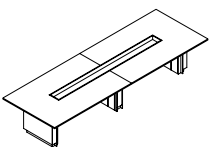
Description	① Model	D	L	H	Seat Capacity	Top Pieces	Bases Required	CTN WT	CU FT	List Price
Rectangular Table with Panel Base and Center Console 	CC8JRPM-48216	48	216	29	16	2	4	702	44	\$24,656
	<ul style="list-style-type: none"> · short grain veneer direction · base CC8NPC2-27174 · plinth base · top is 1 1/4" thick and in two sections · anodized aluminum center console 160" long · laminate worksurface, no charge if standard laminate is selected · base front arc panel, add \$464 to list, arc is only outside bases · glass worksurface with reverse bevel edge, (see page 74) call for quote · aluminum edge available, specify and add \$4,551 list 									
Rectangular Table with Panel Base and Center Console 	CC8JRPM-48192	48	192	29	14	2	4	581	37	\$19,448
	<ul style="list-style-type: none"> · short grain veneer direction · base CC8NPC2-27156 · plinth base · top is 1 1/4" thick and in two sections · anodized aluminum center console 144" long · laminate worksurface, no charge if standard laminate is selected · base front arc panel, add \$464 to list, arc is only outside bases · glass worksurface with reverse bevel edge, (see page 74) call for quote · aluminum edge available, specify and add \$4,137 list 									
Rectangular Table with Panel Base and Center Console 	CC8JRPM-48168	48	168	29	12	2	4	539	34	\$17,250
	<ul style="list-style-type: none"> · short grain veneer direction · base CC8NPC2-27132 · plinth base · top is 1 1/4" thick and in two sections · anodized aluminum center console 120" long · laminate worksurface, no charge if standard laminate is selected · base front arc panel, add \$464 to list, arc is only outside bases · glass worksurface with reverse bevel edge, (see page 74) call for quote · aluminum edge available, specify and add \$3,725 list 									
Rectangular Table with Panel Base and Center Console 	CC8JRPM-48144	48	144	29	8	2	3	497	31	\$15,404
	<ul style="list-style-type: none"> · short grain veneer direction · base CC8NPC2-27108 · plinth base · top is 1 1/4" thick and in two sections · anodized aluminum center console 96" long · laminate worksurface, no charge if standard laminate is selected · base front arc panel, add \$464 to list, arc is only outside bases · glass worksurface with reverse bevel edge, (see page 74) call for quote · aluminum edge available, specify and add \$3,310 list 									

COLLECTIVE CONFERENCE

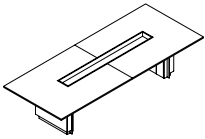
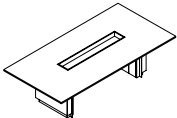
Description	① Model	D	L	H	Seat Capacity	Top Pieces	Bases Required	CTN WT	CU FT	List Price
Rectangular Table with Panel Base and Center Console 	CC8JRPM-48120	48	120	29	6	2	2	376	24	\$10,385
	<ul style="list-style-type: none"> · short grain veneer direction · base CC8NPC2-2784 · plinth base · top is 1 1/4" thick and in two sections · anodized aluminum center console 72" long · laminate worksurface, no charge if standard laminate is selected · base front arc panel, add \$464 to list, arc is only outside bases · glass worksurface with reverse bevel edge, (see page 74) call for quote · aluminum edge available, specify and add \$2,897 list 									
Rectangular Table with Panel Base and Center Console 	CC8JRPM-4896	48	96	29	6	1	2	334	21	\$8,405
	<ul style="list-style-type: none"> · long grain veneer direction · base CC8NPC2-2760 · plinth base · top is 1 1/4" thick · anodized aluminum center console 48" long · laminate worksurface, no charge if standard laminate is selected · base front arc panel, add \$464 to list, arc is only outside bases · glass worksurface with reverse bevel edge, (see page 74) call for quote · aluminum edge available, specify and add \$2,483 list 									

To Order, Specify:

- ① Model Number
- ② Wood Species
- ③ Finish Scheme
 - A. Accent Surround - Veneer or Paint
 - B. Base Pedestal - Veneer or Paint
(see page 78 - apron follows base pedestal)
- ④ Edge Detail
 - A. Straight
 - B. Aluminum Trim
- ⑤ Worksurface Option
 - A. Veneer
 - B. Laminate
 - C. White Back Painted Glass - Glossy
 - D. White Back Painted Glass - Frosted
(see page 74)
- ⑥ Power and Data Options (see page 322)
- ⑦ Other Product Options
- ⑧ Center Console Accessories (see pages 156–157 - order separately)

Description	① Model	D	L	H	Seat Capacity	Top Pieces	Bases Required	CTN WT	CU FT	List Price
<p>Arc End Table with Panel Base</p>	CC8JAP2-60216	60	216	29	16	2	4	813	47	\$23,515
	<ul style="list-style-type: none"> · short grain veneer direction · base CC8NPC2-32174 · plinth base · top is 1 ¼" thick and in two sections · laminate worksurface, no charge if standard laminate is selected · base front arc panel, add \$464 to list, arc is only outside bases · glass worksurface with reverse bevel edge, (see page 74) call for quote 									
<p>Arc End Table with Panel Base</p>	CC8JAP2-60192	60	192	29	14	2	3	682	39	\$18,361
	<ul style="list-style-type: none"> · short grain veneer direction · base CC8NPC2-32156 · plinth base · top is 1 ¼" thick and in two sections · laminate worksurface, no charge if standard laminate is selected · base front arc panel, add \$464 to list, arc is only outside bases · glass worksurface with reverse bevel edge, (see page 74) call for quote 									
<p>Arc End Table with Panel Base</p>	CC8JAP2-60168	60	168	29	14	2	3	630	36	\$16,461
	<ul style="list-style-type: none"> · short grain veneer direction · base CC8NPC2-32132 · plinth base · top is 1 ¼" thick and in two sections · laminate worksurface, no charge if standard laminate is selected · base front arc panel, add \$464 to list, arc is only outside bases · glass worksurface with reverse bevel edge, (see page 74) call for quote 									
<p>Arc End Table with Panel Base</p>	CC8JAP2-60144	60	144	29	12	2	3	578	33	\$14,936
	<ul style="list-style-type: none"> · short grain veneer direction · base CC8NPC2-32108 · plinth base · top is 1 ¼" thick and in two sections · laminate worksurface, no charge if standard laminate is selected · base front arc panel, add \$464 to list, arc is only outside bases · glass worksurface with reverse bevel edge, (see page 74) call for quote 									

COLLECTIVE CONFERENCE

Description	① Model	D	L	H	Seat Capacity	Top Pieces	Bases Required	CTN WT	CU FT	List Price
-------------	---------	---	---	---	---------------	------------	----------------	--------	-------	------------

Arc End Table with Panel Base and Center Console

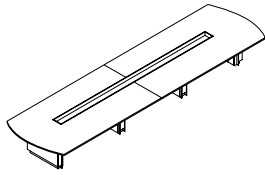

CC8JAPM-60216	60	216	29	18	2	4	814	55	\$28,758
----------------------	----	-----	----	----	---	---	-----	----	----------

- short grain veneer direction
- base CC8NPC2-32174
- plinth base
- top is 1 1/4" thick and in two sections
- anodized aluminum center console 160" long
- laminate worksurface, no charge if standard laminate is selected
- base front arc panel, add \$464 to list, arc is only outside bases
- glass worksurface with reverse bevel edge, (see page 74) call for quote

Arc End Table with Panel Base and Center Console

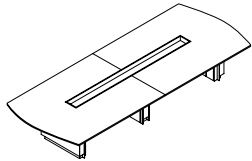

CC8JAPM-60192	60	192	29	16	2	3	682	46	\$22,888
----------------------	----	-----	----	----	---	---	-----	----	----------

- short grain veneer direction
- base CC8NPC2-32156
- plinth base
- top is 1 1/4" thick and in two sections
- anodized aluminum center console 144" long
- laminate worksurface, no charge if standard laminate is selected
- base front arc panel, add \$464 to list, arc is only outside bases
- glass worksurface with reverse bevel edge, (see page 74) call for quote

Arc End Table with Panel Base and Center Console

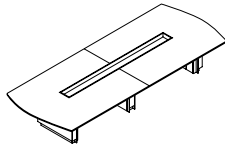

CC8JAPM-60168	60	168	29	14	2	3	631	42	\$20,276
----------------------	----	-----	----	----	---	---	-----	----	----------

- short grain veneer direction
- base CC8NPC2-32132
- plinth base
- top is 1 1/4" thick and in two sections
- anodized aluminum center console 120" long
- laminate worksurface, no charge if standard laminate is selected
- base front arc panel, add \$464 to list, arc is only outside bases
- glass worksurface with reverse bevel edge, (see page 74) call for quote

Arc End Table with Panel Base and Center Console

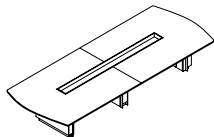

CC8JAPM-60144	60	144	29	10	2	3	578	39	\$18,033
----------------------	----	-----	----	----	---	---	-----	----	----------

- short grain veneer direction
- base CC8NPC2-32108
- plinth base
- top is 1 1/4" thick and in two sections
- anodized aluminum center console 96" long
- laminate worksurface, no charge if standard laminate is selected
- base front arc panel, add \$464 to list, arc is only outside bases
- glass worksurface with reverse bevel edge, (see page 74) call for quote

To Order, Specify:

Arc End Table

- ① Model Number
- ② Wood Species
- ③ Finish Scheme
 - A. Accent Surround - Veneer or Paint
 - B. Base Pedestal - Veneer or Paint
(see page 78 - apron follows base pedestal)
- ④ Worksurface Option
 - A. Veneer
 - B. Laminate
 - C. White Back Painted Glass - Glossy
 - D. White Back Painted Glass - Frosted
(see page 74)
- ⑤ Power and Data Options (see page 322)
- ⑥ Other Product Options

Arc End Table with Center Console

- ① Model Number
- ② Wood Species
- ③ Finish Scheme
 - A. Accent Surround - Veneer or Paint
 - B. Base Pedestal - Veneer or Paint
(see page 78 - apron follows base pedestal)
- ④ Worksurface Option
 - A. Veneer
 - B. Laminate
 - C. White Back Painted Glass - Glossy
 - D. White Back Painted Glass - Frosted
(see page 74)
- ⑤ Power and Data Options (see page 322)
- ⑥ Other Product Options
- ⑦ Center Console Accessories (see pages 156-157 - order separately)

Description	① Model	D	L	H	Seat Capacity	Top Pieces	Bases Required	CTN WT	CU FT	List Price
-------------	---------	---	---	---	---------------	------------	----------------	--------	-------	------------

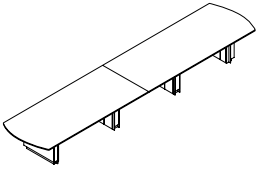
	CC8JAP2-48216	48	216	29	16	2	4	702	38	\$19,916
	<ul style="list-style-type: none"> · short grain veneer direction · base CC8NPC2-27174 · plinth base · top is 1 ¼" thick and in two sections · laminate worksurface, no charge if standard laminate is selected · base front arc panel, add \$464 to list, arc is only outside bases · glass worksurface with reverse bevel edge, (see page 74) call for quote 									

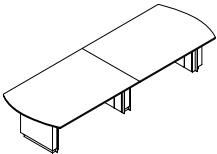
	CC8JAP2-48192	48	192	29	16	2	3	581	32	\$15,355
	<ul style="list-style-type: none"> · short grain veneer direction · base CC8NPC2-27156 · plinth base · top is 1 ¼" thick and in two sections · laminate worksurface, no charge if standard laminate is selected · base front arc panel, add \$464 to list, arc is only outside bases · glass worksurface with reverse bevel edge, (see page 74) call for quote 									

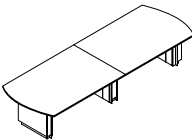
	CC8JAP2-48168	48	168	29	14	2	3	538	29	\$13,812
	<ul style="list-style-type: none"> · short grain veneer direction · base CC8NPC2-27132 · plinth base · top is 1 ¼" thick and in two sections · laminate worksurface, no charge if standard laminate is selected · base front arc panel, add \$464 to list, arc is only outside bases · glass worksurface with reverse bevel edge, (see page 74) call for quote 									

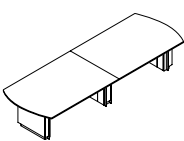
	CC8JAP2-48144	48	144	29	10	2	3	497	27	\$12,620
	<ul style="list-style-type: none"> · short grain veneer direction · base CC8NPC2-27108 · plinth base · top is 1 ¼" thick and in two sections · laminate worksurface, no charge if standard laminate is selected · base front arc panel, add \$464 to list, arc is only outside bases · glass worksurface with reverse bevel edge, (see page 74) call for quote 									

COLLECTIVE CONFERENCE

Description	① Model	D	L	H	Seat Capacity	Top Pieces	Bases Required	CTN WT	CU FT	List Price
-------------	---------	---	---	---	---------------	------------	----------------	--------	-------	------------

Arc End Table with Panel Base	CC8JAP2-48120	48	120	29	6	2	2	375	20	\$8,256
-------------------------------	----------------------	----	-----	----	---	---	---	-----	----	---------

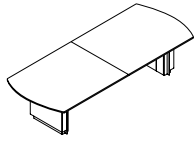

- short grain veneer direction
- base CC8NPC2-2784
- plinth base
- top is 1 1/4" thick and in two sections
- laminate worksurface, no charge if standard laminate is selected
- base front arc panel, add \$464 to list, arc is only outside bases
- glass worksurface with reverse bevel edge, (see page 74) call for quote

Arc End Table with Panel Base	CC8JAP2-4896	48	96	29	6	1	2	334	18	\$6,920
-------------------------------	---------------------	----	----	----	---	---	---	-----	----	---------

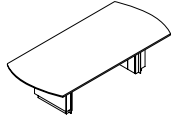

- long grain veneer direction
- base CC8NPC2-2760
- plinth base
- top is 1 1/4" thick
- laminate worksurface, no charge if standard laminate is selected
- base front arc panel, add \$464 to list, arc is only outside bases
- glass worksurface with reverse bevel edge, (see page 74) call for quote

To Order, Specify

- ① Model Number
- ② Wood Species
- ③ Finish Scheme
 - A. Accent Surround - Veneer or Paint
 - B. Base Pedestal - Veneer or Paint
(see page 78 - apron follows base pedestal)
- ④ Worksurface Option
 - A. Veneer
 - B. Laminate
 - C. White Back Painted Glass - Glossy
 - D. White Back Painted Glass - Frosted
(see page 74)
- ⑤ Power and Data Options (see page 322)
- ⑥ Other Product Options

Description	① Model	D	L	H	Seat Capacity	Top Pieces	Bases Required	CTN WT	CU FT	List Price
Arc End Table with Panel Base and Center Console 	CC8JAPM-48216	48	216	29	16	2	4	702	44	\$25,158
	<ul style="list-style-type: none"> · short grain veneer direction · base CC8NPC2-27174 · plinth base · top is 1 1/4" thick and in two sections · anodized aluminum center console 160" long · laminate worksurface, no charge if standard laminate is selected · base front arc panel, add \$464 to list, arc is only outside bases · glass worksurface with reverse bevel edge, (see page 74) call for quote 									
Arc End Table with Panel Base and Center Console 	CC8JAPM-48192	48	192	29	16	2	3	581	37	\$19,884
	<ul style="list-style-type: none"> · short grain veneer direction · base CC8NPC2-27156 · plinth base · top is 1 1/4" thick and in two sections · anodized aluminum center console 144" long · laminate worksurface, no charge if standard laminate is selected · base front arc panel, add \$464 to list, arc is only outside bases · glass worksurface with reverse bevel edge, (see page 74) call for quote 									
Arc End Table with Panel Base and Center Console 	CC8JAPM-48168	48	168	29	14	2	3	539	34	\$17,625
	<ul style="list-style-type: none"> · short grain veneer direction · base CC8NPC2-27132 · plinth base · top is 1 1/4" thick and in two sections · anodized aluminum center console 120" long · laminate worksurface, no charge if standard laminate is selected · base front arc panel, add \$464 to list, arc is only outside bases · glass worksurface with reverse bevel edge, (see page 74) call for quote 									
Arc End Table with Panel Base and Center Console 	CC8JAPM-48144	48	144	29	10	2	3	497	31	\$15,716
	<ul style="list-style-type: none"> · short grain veneer direction · base CC8NPC2-27108 · plinth base · top is 1 1/4" thick and in two sections · anodized aluminum center console 96" long · laminate worksurface, no charge if standard laminate is selected · base front arc panel, add \$464 to list, arc is only outside bases · glass worksurface with reverse bevel edge, (see page 74) call for quote 									

COLLECTIVE CONFERENCE

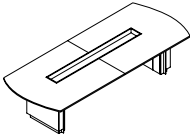
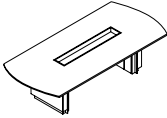
Description	① Model	D	L	H	Seat Capacity	Top Pieces	Bases Required	CTN WT	CU FT	List Price
Arc End Table with Panel Base and Center Console 	CC8JAPM-48120	48	120	29	6	2	2	376	24	\$10,638
	<ul style="list-style-type: none"> · short grain veneer direction · base CC8NPC2-2784 · plinth base · top is 1 1/4" thick and in two sections · anodized aluminum center console 72" long · laminate worksurface, no charge if standard laminate is selected · base front arc panel, add \$464 to list, arc is only outside bases · glass worksurface with reverse bevel edge, (see page 74) call for quote 									
Arc End Table with Panel Base and Center Console 	CC8JAPM-4896	48	96	29	6	1	2	334	21	\$8,587
	<ul style="list-style-type: none"> · long grain veneer direction · base CC8NPC2-2760 · plinth base · top is 1 1/4" thick · anodized aluminum center console 48" long · laminate worksurface, no charge if standard laminate is selected · base front arc panel, add \$464 to list, arc is only outside bases · glass worksurface with reverse bevel edge, (see page 74) call for quote 									

To Order, Specify

- ① Model Number
- ② Wood Species
- ③ Finish Scheme
 - A. Accent Surround - veneer or paint
 - B. Base Pedestal - veneer or paint
(see page 78 - apron follows base pedestal)
- ④ Worksurface Option
 - A. Veneer
 - B. Laminate
 - C. White Back Painted Glass - Glossy
 - D. White Back Painted Glass - Frosted
(see page 74)
- ⑤ Power and Data Options (see page 322)
- ⑥ Other Product Options
- ⑦ Center Console Accessories (see pages 156–157 - order separately)

Description	① Model	D	L	H	Seat Capacity	Top Pieces	Bases Required	CTN WT	CU FT	List Price
Racetrack Table with Panel Base 	CC8JOP2-60216	60	216	29	18	2	4	788	47	\$23,734
	<ul style="list-style-type: none"> · short grain veneer direction · base CC8NPC2-32174 · plinth base · top is 1 ¼" thick and in two sections · laminate worksurface, no charge if standard laminate is selected · base front arc panel, add \$464 to list, arc is only outside bases · glass worksurface with reverse bevel edge, (see page 74) call for quote 									
Racetrack Table with Panel Base 	CC8JOP2-60192	60	192	29	14	2	3	657	39	\$18,550
	<ul style="list-style-type: none"> · short grain veneer direction · base CC8NPC2-32156 · plinth base · top is 1 ¼" thick and in two sections · laminate worksurface, no charge if standard laminate is selected · base front arc panel, add \$464 to list, arc is only outside bases · glass worksurface with reverse bevel edge, (see page 74) call for quote 									
Racetrack Table with Panel Base 	CC8JOP2-60168	60	168	29	12	2	3	605	36	\$16,625
	<ul style="list-style-type: none"> · short grain veneer direction · base CC8NPC2-32132 · plinth base · top is 1 ¼" thick and in two sections · laminate worksurface, no charge if standard laminate is selected · base front arc panel, add \$464 to list, arc is only outside bases · glass worksurface with reverse bevel edge, (see page 74) call for quote 									
Racetrack Table with Panel Base 	CC8JOP2-60144	60	144	29	8	2	3	553	33	\$15,069
	<ul style="list-style-type: none"> · short grain veneer direction · base CC8NPC2-32108 · plinth base · top is 1 ¼" thick and in two sections · laminate worksurface, no charge if standard laminate is selected · base front arc panel, add \$464 to list, arc is only outside bases · glass worksurface with reverse bevel edge, (see page 74) call for quote 									

COLLECTIVE CONFERENCE

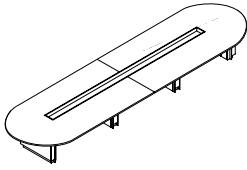
Description	① Model	D	L	H	Seat Capacity	Top Pieces	Bases Required	CTN WT	CU FT	List Price
Racetrack Table with Panel Base and Center Console 	CC8JOPM-60216	60	216	29	18	2	4	789	55	\$28,975
<ul style="list-style-type: none"> • short grain veneer direction • base CC8NPC2-32174 • plinth base • top is 1 ¼" thick and in two sections • anodized aluminum center console 160" long • laminate worksurface, no charge if standard laminate is selected • base front arc panel, add \$464 to list, arc is only outside bases • glass worksurface with reverse bevel edge, (see page 74) call for quote 										

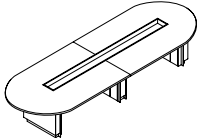
Racetrack Table with Panel Base and Center Console 	CC8JOPM-60192	60	192	29	16	2	3	657	46	\$23,441
<ul style="list-style-type: none"> • short grain veneer direction • base CC8NPC2-32156 • plinth base • top is 1 ¼" thick and in two sections • anodized aluminum center console 144" long • laminate worksurface, no charge if standard laminate is selected • base front arc panel, add \$464 to list, arc is only outside bases • glass worksurface with reverse bevel edge, (see page 74) call for quote 										

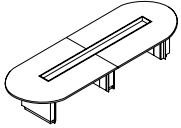
Racetrack Table with Panel Base and Center Console 	CC8JOPM-60168	60	168	29	14	2	3	606	42	\$20,437
<ul style="list-style-type: none"> • short grain veneer direction • base CC8NPC2-32132 • plinth base • top is 1 ¼" thick and in two sections • anodized aluminum center console 120" long • laminate worksurface, no charge if standard laminate is selected • base front arc panel, add \$464 to list, arc is only outside bases • glass worksurface with reverse bevel edge, (see page 74) call for quote 										

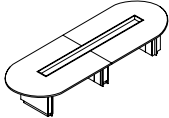
Racetrack Table with Panel Base and Center Console 	CC8JOPM-60144	60	144	29	10	2	3	553	39	\$18,169
<ul style="list-style-type: none"> • short grain veneer direction • base CC8NPC2-32108 • plinth base • top is 1 ¼" thick and in two sections • anodized aluminum center console 96" long • laminate worksurface, no charge if standard laminate is selected • base front arc panel, add \$464 to list, arc is only outside bases • glass worksurface with reverse bevel edge, (see page 74) call for quote 										

To Order, Specify:

Racetrack Table

- ① Model Number
- ② Wood Species
- ③ Finish Scheme
 - A. Accent Surround - Veneer or Paint
 - B. Base Pedestal - Veneer or Paint
(see page 78 - apron follows base pedestal)
- ④ Worksurface Option
 - A. Veneer
 - B. Laminate
 - C. White Back Painted Glass - Glossy
 - D. White Back Painted Glass - Frosted
(see page 74)
- ⑤ Power and Data Options (see page 322)
- ⑥ Other Product Options

Racetrack Table with Center Console

- ① Model Number
- ② Wood Species
- ③ Finish Scheme
 - A. Accent Surround - Veneer or Paint
 - B. Base Pedestal - Veneer or Paint
(see page 78 - apron follows base pedestal)
- ④ Worksurface Option
 - A. Veneer
 - B. Laminate
 - C. White Back Painted Glass - Glossy
 - D. White Back Painted Glass - Frosted
(see page 74)
- ⑤ Power and Data Options (see page 322)
- ⑥ Other Product Options
- ⑦ Center Console Accessories (see pages 156-157 - order separately)

Description	① Model	D	L	H	Seat Capacity	Top Pieces	Bases Required	CTN WT	CU FT	List Price
Racetrack Table with Panel Base 	CC8JOP2-48216	48	216	29	16	2	4	694	38	\$20,083
	<ul style="list-style-type: none"> · short grain veneer direction · base CC8NPC2-27174 · plinth base · top is 1 ¼" thick and in two sections · laminate worksurface, no charge if standard laminate is selected · base front arc panel, add \$464 to list, arc is only outside bases · glass worksurface with reverse bevel edge, (see page 74) call for quote 									
Racetrack Table with Panel Base 	CC8JOP2-48192	48	192	29	14	2	3	565	32	\$18,912
	<ul style="list-style-type: none"> · short grain veneer direction · base CC8NPC2-27156 · plinth base · top is 1 ¼" thick and in two sections · laminate worksurface, no charge if standard laminate is selected · base front arc panel, add \$464 to list, arc is only outside bases · glass worksurface with reverse bevel edge, (see page 74) call for quote 									
Racetrack Table with Panel Base 	CC8JOP2-48168	48	168	29	12	2	3	531	29	\$13,937
	<ul style="list-style-type: none"> · short grain veneer direction · base CC8NPC2-27132 · plinth base · top is 1 ¼" thick and in two sections · laminate worksurface, no charge if standard laminate is selected · base front arc panel, add \$464 to list, arc is only outside bases · glass worksurface with reverse bevel edge, (see page 74) call for quote 									
Racetrack Table with Panel Base 	CC8JOP2-48144	48	144	29	8	2	3	481	27	\$12,723
	<ul style="list-style-type: none"> · short grain veneer direction · base CC8NPC2-27108 · plinth base · top is 1 ¼" thick and in two sections · laminate worksurface, no charge if standard laminate is selected · base front arc panel, add \$464 to list, arc is only outside bases · glass worksurface with reverse bevel edge, (see page 74) call for quote 									

COLLECTIVE CONFERENCE

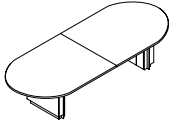
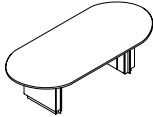
Description	① Model	D	L	H	Seat Capacity	Top Pieces	Bases Required	CTN WT	CU FT	List Price
Racetrack Table with Panel Base 	CC8JOP2-48120	48	120	29	6	2	2	359	20	\$8,341
	<ul style="list-style-type: none"> · short grain veneer direction · base CC8NPC2-2784 · plinth base · top is 1 ¼" thick and in two sections · laminate worksurface, no charge if standard laminate is selected · base front arc panel, add \$464 to list, arc is only outside bases · glass worksurface with reverse bevel edge, (see page 74) call for quote 									
Racetrack Table with Panel Base 	CC8JOP2-4896	48	96	29	6	1	2	309	18	\$6,982
	<ul style="list-style-type: none"> · long grain veneer direction · base CC8NPC2-2760 · plinth base · top is 1 ¼" thick · laminate worksurface, no charge if standard laminate is selected · base front arc panel, add \$464 to list, arc is only outside bases · glass worksurface with reverse bevel edge, (see page 74) call for quote 									

To Order, Specify:

- ① Model Number
- ② Wood Species
- ③ Finish Scheme
 - A. Accent Surround - Veneer or Paint
 - B. Base Pedestal - Veneer or Paint
(see page 78 - apron follows base pedestal)
- ④ Worksurface Option
 - A. Veneer
 - B. Laminate
 - C. White Back Painted Glass - Glossy
 - D. White Back Painted Glass - Frosted
(see page 74)
- ⑤ Power and Data Options (see page 322)
- ⑥ Other Product Options

Description	① Model	D	L	H	Seat Capacity	Top Pieces	Bases Required	CTN WT	CU FT	List Price
<p>Racetrack Table with Panel Base and Center Console</p>	CC8JOPM-48216	48	216	29	16	2	4	694	44	\$25,326
	<ul style="list-style-type: none"> · short grain veneer direction · base CC8NPC2-27174 · plinth base · top is 1 ¼" thick and in two sections · anodized aluminum center console 160" long · laminate worksurface, no charge if standard laminate is selected · base front arc panel, add \$464 to list, arc is only outside bases · glass worksurface with reverse bevel edge, (see page 74) call for quote 									
<p>Racetrack Table with Panel Base and Center Console</p>	CC8JOPM-48192	48	192	29	14	2	3	566	37	\$20,030
	<ul style="list-style-type: none"> · short grain veneer direction · base CC8NPC2-27156 · plinth base · top is 1 ¼" thick and in two sections · anodized aluminum center console 144" long · laminate worksurface, no charge if standard laminate is selected · base front arc panel, add \$464 to list, arc is only outside bases · glass worksurface with reverse bevel edge, (see page 74) call for quote 									
<p>Racetrack Table with Panel Base and Center Console</p>	CC8JOPM-48168	48	168	29	12	2	3	531	34	\$17,752
	<ul style="list-style-type: none"> · short grain veneer direction · base CC8NPC2-27132 · plinth base · top is 1 ¼" thick and in two sections · anodized aluminum center console 120" long · laminate worksurface, no charge if standard laminate is selected · base front arc panel, add \$464 to list, arc is only outside bases · glass worksurface with reverse bevel edge, (see page 74) call for quote 									
<p>Racetrack Table with Panel Base and Center Console</p>	CC8JOPM-48144	48	144	29	8	2	3	482	31	\$15,822
	<ul style="list-style-type: none"> · short grain veneer direction · base CC8NPC2-27108 · plinth base · top is 1 ¼" thick and in two sections · anodized aluminum center console 96" long · laminate worksurface, no charge if standard laminate is selected · base front arc panel, add \$464 to list, arc is only outside bases · glass worksurface with reverse bevel edge, (see page 74) call for quote 									

COLLECTIVE CONFERENCE

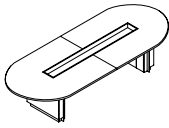
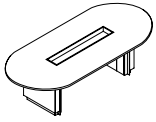
Description	① Model	D	L	H	Seat Capacity	Top Pieces	Bases Required	CTN WT	CU FT	List Price
Racetrack Table with Panel Base and Center Console 	CC8JOPM-48120	48	120	29	6	2	2	360	24	\$10,724
	<ul style="list-style-type: none"> · short grain veneer direction · base CC8NPC2-2784 · plinth base · top is 1 1/4" thick and in two sections · anodized aluminum center console 72" long · laminate worksurface, no charge if standard laminate is selected · base front arc panel, add \$464 to list, arc is only outside bases · glass worksurface with reverse bevel edge, (see page 74) call for quote 									
Racetrack Table with Panel Base and Center Console 	CC8JOPM-4896	48	96	29	6	1	2	310	21	\$8,649
	<ul style="list-style-type: none"> · long grain veneer direction · base CC8NPC2-2760 · plinth base · top is 1 1/4" thick · anodized aluminum center console 48" long · laminate worksurface, no charge if standard laminate is selected · base front arc panel, add \$464 to list, arc is only outside bases · glass worksurface with reverse bevel edge, (see page 74) call for quote 									

To Order, Specify:

- ① Model Number
- ② Wood Species
- ③ Finish Scheme
 - A. Accent Surround - Veneer or Paint
 - B. Base Pedestal - Veneer or Paint
(see page 78 - apron follows base pedestal)
- ④ Worksurface Option
 - A. Veneer
 - B. Laminate
 - C. White Back Painted Glass - Glossy
 - D. White Back Painted Glass - Frosted
(see page 74)
- ⑤ Power and Data Options (see page 322)
- ⑥ Other Product Options
- ⑦ Center Console Accessories (see pages 156–157 - order separately)

Description	① Model	D	L	H	Seat Capacity	Top Pieces	Bases Required	CTN WT	CU FT	List Price
Boat Shape Table with Panel Base	CC8JBP2-60216	60	216	29	16	2	4	736	47	\$22,926

- short grain veneer direction
- base CC8NPC2-32174
- plinth base
- top is 1 1/4" thick and in two sections
- laminate worksurface, no charge if standard laminate is selected
- base front arc panel, add \$464 to list, arc is only outside bases
- glass worksurface with reverse bevel edge, (see page 74) call for quote

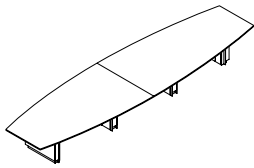

Boat Shape Table with Panel Base	CC8JBP2-60192	60	192	29	14	2	3	613	39	\$17,936
----------------------------------	----------------------	----	-----	----	----	---	---	-----	----	----------

- short grain veneer direction
- base CC8NPC2-32156
- plinth base
- top is 1 1/4" thick and in two sections
- laminate worksurface, no charge if standard laminate is selected
- base front arc panel, add \$464 to list, arc is only outside bases
- glass worksurface with reverse bevel edge, (see page 74) call for quote

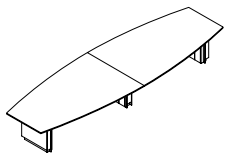

Boat Shape Table with Panel Base	CC8JBP2-60168	60	168	29	12	2	3	570	36	\$16,127
----------------------------------	----------------------	----	-----	----	----	---	---	-----	----	----------

- short grain veneer direction
- base CC8NPC2-32132
- plinth base
- top is 1 1/4" thick and in two sections
- laminate worksurface, no charge if standard laminate is selected
- base front arc panel, add \$464 to list, arc is only outside bases
- glass worksurface with reverse bevel edge, (see page 74) call for quote

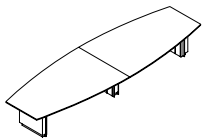

COLLECTIVE CONFERENCE

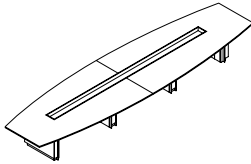
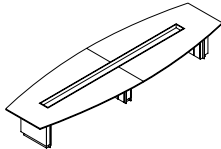
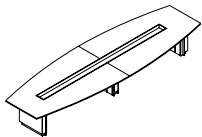
Description	① Model	D	L	H	Seat Capacity	Top Pieces	Bases Required	CTN WT	CU FT	List Price
Boat Shape Table with Panel Base and Center Console 	CC8JBPM-60216	60	216	29	16	2	4	737	55	\$28,170
	<ul style="list-style-type: none"> • short grain veneer direction • base CC8NPC2-32174 • plinth base • top is 1 1/4" thick and in two sections • anodized aluminum center console 160" long • laminate worksurface, no charge if standard laminate is selected • base front arc panel, add \$464 to list, arc is only outside bases • glass worksurface with reverse bevel edge, (see page 74) call for quote 									
Boat Shape Table with Panel Base and Center Console 	CC8JBPM-60192	60	192	29	14	2	3	613	46	\$22,464
	<ul style="list-style-type: none"> • short grain veneer direction • base CC8NPC2-32156 • plinth base • top is 1 1/4" thick and in two sections • anodized aluminum center console 144" long • laminate worksurface, no charge if standard laminate is selected • base front arc panel, add \$464 to list, arc is only outside bases • glass worksurface with reverse bevel edge, (see page 74) call for quote 									
Boat Shape Table with Panel Base and Center Console 	CC8JBPM-60168	60	168	29	12	2	3	571	42	\$19,942
	<ul style="list-style-type: none"> • short grain veneer direction • base CC8NPC2-32132 • plinth base • top is 1 1/4" thick and in two sections • anodized aluminum center console 120" long • laminate worksurface, no charge if standard laminate is selected • base front arc panel, add \$464 to list, arc is only outside bases • glass worksurface with reverse bevel edge, (see page 74) call for quote 									

To Order, Specify:

Boat Shape Table

- ① Model Number
- ② Wood Species
- ③ Finish Scheme
 - A. Accent Surround - Veneer or Paint
 - B. Base Pedestal - Veneer or Paint
(see page 78 - apron follows base pedestal)
- ④ Worksurface Option
 - A. Veneer
 - B. Laminate
 - C. White Back Painted Glass - Glossy
 - D. White Back Painted Glass - Frosted
(see page 74)
- ⑤ Power and Data Options (see page 322)
- ⑥ Other Product Options

Boat Shape Table with Center Console

- ① Model Number
- ② Wood Species
- ③ Finish Scheme
 - A. Accent Surround - Veneer or Paint
 - B. Base Pedestal - Veneer or Paint
(see page 78 - apron follows base pedestal)
- ④ Worksurface Option
 - A. Veneer
 - B. Laminate
 - C. White Back Painted Glass - Glossy
 - D. White Back Painted Glass - Frosted
(see page 74)
- ⑤ Power and Data Options (see page 322)
- ⑥ Other Product Options
- ⑦ Center Console Accessories (see pages 156-157 - order separately)

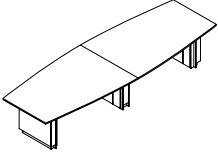
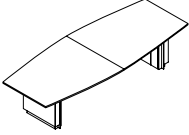
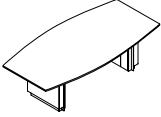
Description	① Model	D	L	H	Seat Capacity	Top Pieces	Bases Required	CTN WT	CU FT	List Price
Boat Shape Table with Panel Base 	CC8JBP2-48144	48	144	29	8	2	3	469	27	\$14,678
	<ul style="list-style-type: none"> · short grain veneer direction · base CC8NPC2-27108 · plinth base · top is 1 ¼" thick and in two sections · laminate worksurface, no charge if standard laminate is selected · base front arc panel, add \$464 to list, arc is only outside bases · glass worksurface with reverse bevel edge, (see page 74) call for quote 									
Boat Shape Table with Panel Base 	CC8JBP2-48120	48	120	29	6	2	2	352	20	\$9,381
	<ul style="list-style-type: none"> · short grain veneer direction · base CC8NPC2-2784 · plinth base · top is 1 ¼" thick and in two sections · laminate worksurface, no charge if standard laminate is selected · base front arc panel, add \$464 to list, arc is only outside bases · glass worksurface with reverse bevel edge, (see page 74) call for quote 									
Boat Shape Table with Panel Base 	CC8JBP2-4896	48	96	29	6	1	2	315	18	\$7,763
	<ul style="list-style-type: none"> · long grain veneer direction · base CC8NPC2-2760 · plinth base · top is 1 ¼" thick · laminate worksurface, no charge if standard laminate is selected · base front arc panel, add \$464 to list, arc is only outside bases · glass worksurface with reverse bevel edge, (see page 74) call for quote 									

COLLECTIVE CONFERENCE

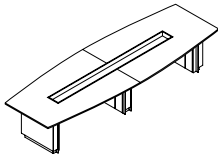
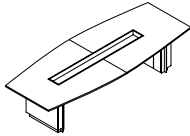
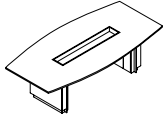
Description	① Model	D	L	H	Seat Capacity	Top Pieces	Bases Required	CTN WT	CU FT	List Price
Boat Shape Table with Panel Base and Center Console 	CC8JBPM-48144	48	144	29	8	2	3	470	31	\$17,777
	<ul style="list-style-type: none"> • short grain veneer direction • base CC8NPC2-27108 • plinth base • top is 1 1/4" thick and in two sections • anodized aluminum center console 96" long • laminate worksurface, no charge if standard laminate is selected • base front arc panel, add \$464 to list, arc is only outside bases • glass worksurface with reverse bevel edge, (see page 74) call for quote 									
Boat Shape Table with Panel Base and Center Console 	CC8JBPM-48120	48	120	29	6	2	2	353	24	\$11,764
	<ul style="list-style-type: none"> • short grain veneer direction • base CC8NPC2-2784 • plinth base • top is 1 1/4" thick and in two sections • anodized aluminum center console 72" long • laminate worksurface, no charge if standard laminate is selected • base front arc panel, add \$464 to list, arc is only outside bases • glass worksurface with reverse bevel edge, (see page 74) call for quote 									
Boat Shape Table with Panel Base and Center Console 	CC8JBPM-4896	48	96	29	6	1	2	316	21	\$9,429
	<ul style="list-style-type: none"> • long grain veneer direction • base CC8NPC2-2760 • plinth base • top is 1 1/4" thick • anodized aluminum center console 48" long • laminate worksurface, no charge if standard laminate is selected • base front arc panel, add \$464 to list, arc is only outside bases • glass worksurface with reverse bevel edge, (see page 74) call for quote 									

To Order, Specify:

Boat Shape Table

- ① Model Number
- ② Wood Species
- ③ Finish Scheme
 - A. Accent Surround - Veneer or Paint
 - B. Base Pedestal - Veneer or Paint
(see page 78 - apron follows base pedestal)
- ④ Worksurface Option
 - A. Veneer
 - B. Laminate
 - C. White Back Painted Glass - Glossy
 - D. White Back Painted Glass - Frosted
(see page 74)
- ⑤ Power and Data Options (see page 322)
- ⑥ Other Product Options

Boat Shape Table with Center Console

- ① Model Number
- ② Wood Species
- ③ Finish Scheme
 - A. Accent Surround - Veneer or Paint
 - B. Base Pedestal - Veneer or Paint
(see page 78 - apron follows base pedestal)
- ④ Worksurface Option
 - A. Veneer
 - B. Laminate
 - C. White Back Painted Glass - Glossy
 - D. White Back Painted Glass - Frosted
(see page 74)
- ⑤ Power and Data Options (see page 322)
- ⑥ Other Product Options
- ⑦ Center Console Accessories (see pages 156-157 - order separately)

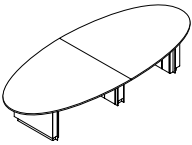
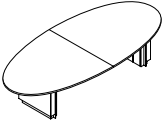
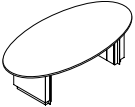
Description	① Model	D	L	H	Seat Capacity	Top Pieces	Bases Required	CTN WT	CU FT	List Price
Ellipse Table with Panel Base 	CC8JEP2-60144	60	144	29	10	2	3	508	33	\$17,575
	<ul style="list-style-type: none"> · short grain veneer direction · base CC8NPC2-32108 · plinth base · top is 1 1/4" thick and in two sections · laminate worksurface, no charge if standard laminate is selected · base front arc panel, add \$464 to list, arc is only outside bases · glass worksurface with reverse bevel edge, (see page 74) call for quote 									
Ellipse Table with Panel Base 	CC8JEP2-54120	54	120	29	8	2	2	348	22	\$11,978
	<ul style="list-style-type: none"> · short grain veneer direction · base CC8NPC2-2784 · plinth base · top is 1 1/4" thick and in two sections · laminate worksurface, no charge if standard laminate is selected · base front arc panel, add \$464 to list, arc is only outside bases · glass worksurface with reverse bevel edge, (see page 74) call for quote 									
Ellipse Table with Panel Base 	CC8JEP2-4896	48	96	29	6	1	2	297	18	\$8,125
	<ul style="list-style-type: none"> · long grain veneer direction · base CC8NPC2-2760 · plinth base · top is 1 1/4" thick · laminate worksurface, no charge if standard laminate is selected · base front arc panel, add \$464 to list, arc is only outside bases · glass worksurface with reverse bevel edge, (see page 74) call for quote 									

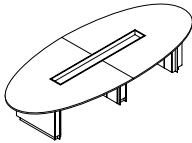
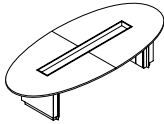
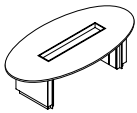
Description	① Model	D	L	H	Seat Capacity	Top Pieces	Bases Required	CTN WT	CU FT	List Price
Ellipse Table with Panel Base and Center Console 	CC8JEPM-60144	60	144	29	10	2	3	508	39	\$20,674
	<ul style="list-style-type: none"> • short grain veneer direction • base CC8NPC2-32108 • plinth base • top is 1 1/4" thick and in two sections • anodized aluminum center console 96" long • laminate worksurface, no charge if standard laminate is selected • base front arc panel, add \$464 to list, arc is only outside bases • glass worksurface with reverse bevel edge, (see page 74) call for quote 									
Ellipse Table with Panel Base and Center Console 	CC8JEPM-54120	54	120	29	8	2	2	349	26	\$14,360
	<ul style="list-style-type: none"> • short grain veneer direction • base CC8NPC2-2784 • plinth base • top is 1 1/4" thick and in two sections • anodized aluminum center console 72" long • laminate worksurface, no charge if standard laminate is selected • base front arc panel, add \$464 to list, arc is only outside bases • glass worksurface with reverse bevel edge, (see page 74) call for quote 									
Ellipse Table with Panel Base and Center Console 	CC8JEPM-4896	48	96	29	6	1	2	298	21	\$9,666
	<ul style="list-style-type: none"> • long grain veneer direction • base CC8NPC2-2760 • plinth base • top is 1 1/4" thick • anodized aluminum center console 48" long • laminate worksurface, no charge if standard laminate is selected • base front arc panel, add \$464 to list, arc is only outside bases • glass worksurface with reverse bevel edge, (see page 74) call for quote 									

To Order, Specify:

Ellipse Tables

- ① Model Number
- ② Wood Species
- ③ Finish Scheme
 - A. Accent Surround - Veneer or Paint
 - B. Base Pedestal - Veneer or Paint
(see page 78 - apron follows base pedestal)
- ④ Worksurface Option
 - A. Veneer
 - B. Laminate
 - C. White Back Painted Glass - Glossy
 - D. White Back Painted Glass - Frosted
(see page 74)
- ⑤ Power and Data Options (see page 322)
- ⑥ Other Product Options

Ellipse Table with Center Console

- ① Model Number
- ② Wood Species
- ③ Finish Scheme
 - A. Accent Surround - Veneer or Paint
 - B. Base Pedestal - Veneer or Paint
(see page 78 - apron follows base pedestal)
- ④ Worksurface Option
 - A. Veneer
 - B. Laminate
 - C. White Back Painted Glass - Glossy
 - D. White Back Painted Glass - Frosted
(see page 74)
- ⑤ Power and Data Options (see page 322)
- ⑥ Other Product Options
- ⑦ Center Console Accessories (see pages 156-157 - order separately)

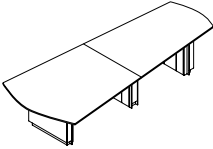
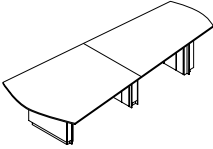
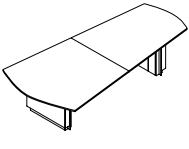
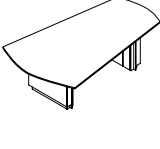
Description	① Model	D	L	H	Seat Capacity	Top Pieces	Bases Required	CTN WT	CU FT	List Price
View Table with Panel Base 	CC8JVP2-60168	60	168	29	11	2	3	560	34	\$16,729
	<ul style="list-style-type: none"> · short grain veneer direction · base CC8NPC9-32168 · plinth base · top is 1 1/4" thick and in two sections · laminate worksurface, no charge if standard laminate is selected · glass worksurface with reverse bevel edge, (see page 74) call for quote · top size: 168"w x 40/60"d 									
View Table with Panel Base 	CC8JVP2-60144	60	144	29	11	2	3	516	31	\$15,161
	<ul style="list-style-type: none"> · short grain veneer direction · base CC8NPC9-32144 · plinth base · top is 1 1/4" thick and in two sections · laminate worksurface, no charge if standard laminate is selected · glass worksurface with reverse bevel edge, (see page 74) call for quote · top size: 144"w x 40/60"d 									
View Table with Panel Base 	CC8JVP2-60120	60	120	29	9	2	2	394	24	\$9,711
	<ul style="list-style-type: none"> · short grain veneer direction · base CC8NPC9-32120 · plinth base · top is 1 1/4" thick and in two sections · laminate worksurface, no charge if standard laminate is selected · glass worksurface with reverse bevel edge, (see page 74) call for quote · top size: 120"w x 40/60"d 									
View Table with Panel Base 	CC8JVP2-6096	60	96	29	7	1	2	350	21	\$8,071
	<ul style="list-style-type: none"> · long grain veneer direction · base CC8NPC9-3296 · plinth base · top is 1 1/4" thick · laminate worksurface, no charge if standard laminate is selected · glass worksurface with reverse bevel edge, (see page 74) call for quote · top size: 96"w x 40/60"d 									

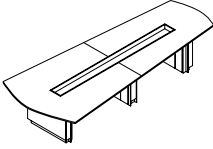
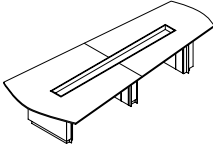
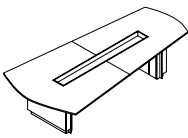
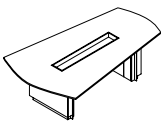
Description	① Model	D	L	H	Seat Capacity	Top Pieces	Bases Required	CTN WT	CU FT	List Price
View Table with Panel Base and Center Console 	CC8JVPM-60168	60	168	29	11	2	3	561	40	\$20,542
	<ul style="list-style-type: none"> • short grain veneer direction • base CC8NPC9-32168 • plinth base • top is 1 1/4" thick and in two sections • anodized aluminum center console 120" long ▲ • laminate worksurface, no charge if standard laminate is selected • glass worksurface with reverse bevel edge, (see page 74) call for quote • top size: 168"w x 40/60"d 									
View Table with Panel Base and Center Console 	CC8JVPM-60144	60	144	29	11	2	3	516	37	\$18,260
	<ul style="list-style-type: none"> • short grain veneer direction • base CC8NPC9-32144 • plinth base • top is 1 1/4" thick and in two sections • anodized aluminum center console 96" long ▲ • laminate worksurface, no charge if standard laminate is selected • glass worksurface with reverse bevel edge, (see page 74) call for quote • top size: 144"w x 40/60"d 									
View Table with Panel Base and Center Console 	CC8JVPM-60120	60	120	29	9	2	2	394	29	\$12,094
	<ul style="list-style-type: none"> • short grain veneer direction • base CC8NPC9-32120 • plinth base • top is 1 1/4" thick and in two sections • anodized aluminum center console 72" long ▲ • laminate worksurface, no charge if standard laminate is selected • glass worksurface with reverse bevel edge, (see page 74) call for quote • top size: 120"w x 40/60"d 									
View Table with Panel Base and Center Console 	CC8JVPM-6096	60	96	29	7	1	2	350	25	\$9,739
	<ul style="list-style-type: none"> • long grain veneer direction • base CC8NPC9-3296 • plinth base • top is 1 1/4" thick • anodized aluminum center console 48" long ▲ • laminate worksurface, no charge if standard laminate is selected • glass worksurface with reverse bevel edge, (see page 74) call for quote • top size: 96"w x 40/60"d 									

To Order, Specify:

- ① Model Number
- ② Wood Species
- ③ Finish Scheme
 - A. Accent Surround - Veneer or Paint
 - B. Base Pedestal - Veneer or Paint
(see page 78 - apron follows base pedestal)
- ④ Worksurface Option
 - A. Veneer
 - B. Laminate
 - C. White Back Painted Glass - Glossy
 - D. White Back Painted Glass - Frosted
(see page 74)
- ⑤ Power and Data Options (see page 322)
- ⑥ Other Product Options

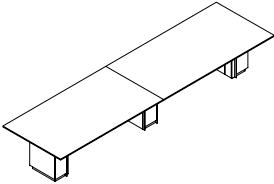
Description	① Model	D	L	H	Seat Capacity	Top Pieces	Bases Required	CTN WT	CU FT	List Price
Rectangular Table with Rectangular Base 	CC8JRR2-60216	60	216	29	18	2	3	787	42	\$25,052
	<ul style="list-style-type: none"> · short grain veneer direction · base CC8NRC2-27174 · plinth base · top is 1 1/4" thick and in two sections · laminate worksurface, no charge if standard laminate is selected · glass worksurface with reverse bevel edge, (see page 74) call for quote · aluminum edge available, specify and add \$4,757 list 									

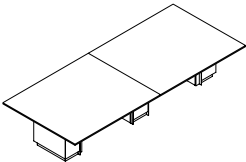
Rectangular Table with Rectangular Base 	CC8JRR2-60192	60	192	29	16	2	3	737	39	\$19,436
	<ul style="list-style-type: none"> · short grain veneer direction · base CC8NRC2-27156 · plinth base · top is 1 1/4" thick and in two sections · laminate worksurface, no charge if standard laminate is selected · glass worksurface with reverse bevel edge, (see page 74) call for quote · aluminum edge available, specify and add \$4,345 list 									

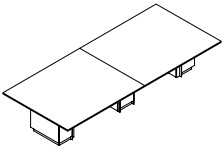
Rectangular Table with Rectangular Base 	CC8JRR2-60168	60	168	29	14	2	3	683	36	\$17,621
	<ul style="list-style-type: none"> · short grain veneer direction · base CC8NRC2-27132 · plinth base · top is 1 1/4" thick and in two sections · laminate worksurface, no charge if standard laminate is selected · glass worksurface with reverse bevel edge, (see page 74) call for quote · aluminum edge available, specify and add \$3,932 list 									

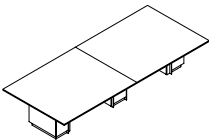
Rectangular Table with Rectangular Base 	CC8JRR2-60144	60	144	29	10	2	3	632	33	\$16,173
	<ul style="list-style-type: none"> · short grain veneer direction · base CC8NRC2-27108 · plinth base · top is 1 1/4" thick and in two sections · laminate worksurface, no charge if standard laminate is selected · glass worksurface with reverse bevel edge, (see page 74) call for quote · aluminum edge available, specify and add \$3,517 list 									

COLLECTIVE CONFERENCE

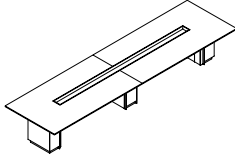
Description	① Model	D	L	H	Seat Capacity	Top Pieces	Bases Required	CTN WT	CU FT	List Price
Rectangular Table with Rectangular Base and Center Console 	CC8JRRM-60216	60	216	29	18	2	3	788	50	\$30,295
<ul style="list-style-type: none"> • short grain veneer direction • base CC8NRC2-27174 • plinth base • top is 1 1/4" thick and in two sections • anodized aluminum center console 160" long • laminate worksurface, no charge if standard laminate is selected • glass worksurface with reverse bevel edge, (see page 74) call for quote • aluminum edge available, specify and add \$4,757 list 										

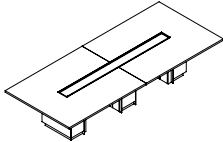
Rectangular Table with Rectangular Base and Center Console 	CC8JRRM-60192	60	192	29	16	2	3	737	46	\$23,964
<ul style="list-style-type: none"> • short grain veneer direction • base CC8NRC2-27156 • plinth base • top is 1 1/4" thick and in two sections • anodized aluminum center console 144" long • laminate worksurface, no charge if standard laminate is selected • glass worksurface with reverse bevel edge, (see page 74) call for quote • aluminum edge available, specify and add \$4,345 list 										

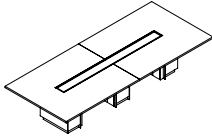
Rectangular Table with Rectangular Base and Center Console 	CC8JRRM-60168	60	168	29	14	2	3	684	42	\$21,433
<ul style="list-style-type: none"> • short grain veneer direction • base CC8NRC2-27132 • plinth base • top is 1 1/4" thick and in two sections • anodized aluminum center console 120" long • laminate worksurface, no charge if standard laminate is selected • glass worksurface with reverse bevel edge, (see page 74) call for quote • aluminum edge available, specify and add \$3,932 list 										

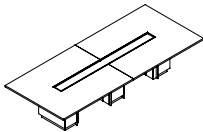
Rectangular Table with Rectangular Base and Center Console 	CC8JRRM-60144	60	144	29	10	2	3	632	39	\$19,270
<ul style="list-style-type: none"> • short grain veneer direction • base CC8NRC2-27108 • plinth base • top is 1 1/4" thick and in two sections • anodized aluminum center console 96" long • laminate worksurface, no charge if standard laminate is selected • glass worksurface with reverse bevel edge, (see page 74) call for quote • aluminum edge available, specify and add \$3,517 list 										

To Order, Specify:

Rectangular Table

- ① Model Number
- ② Wood Species
- ③ Finish Scheme
 - A. Accent Surround - Veneer or Paint
 - B. Base Pedestal - Veneer or Paint
(see page 78 - apron follows base pedestal)
- ④ Worksurface Option
 - A. Veneer
 - B. Laminate
 - C. White Back Painted Glass - Glossy
 - D. White Back Painted Glass - Frosted
(see page 74)
- ⑤ Power and Data Options (see page 322)
- ⑥ Other Product Options

Rectangular Table with Center Console

- ① Model Number
- ② Wood Species
- ③ Finish Scheme
 - A. Accent Surround - Veneer or Paint
 - B. Base Pedestal - Veneer or Paint
(see page 78 - apron follows base pedestal)
- ④ Worksurface Option
 - A. Veneer
 - B. Laminate
 - C. White Back Painted Glass - Glossy
 - D. White Back Painted Glass - Frosted
(see page 74)
- ⑤ Power and Data Options (see page 322)
- ⑥ Other Product Options
- ⑦ Center Console Accessories (see pages 156-157 - order separately)

Description	① Model	D	L	H	Seat Capacity	Top Pieces	Bases Required	CTN WT	CU FT	List Price
Rectangular Table with Rectangular Base	CC8JRR2-48216	48	216	29	16	2	3	654	37	\$21,331

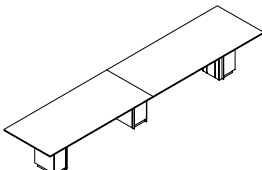

- short grain veneer direction
- base CC8NRC2-21174
- plinth base
- top is 1 1/4" thick and in two sections
- laminate worksurface, no charge if standard laminate is selected
- glass worksurface with reverse bevel edge, (see page 74) call for quote
- aluminum edge available, specify and add \$4,562 list

Rectangular Table with Rectangular Base	CC8JRR2-48192	48	192	29	14	2	3	612	35	\$16,358
---	----------------------	----	-----	----	----	---	---	-----	----	----------

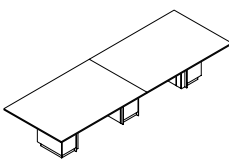

- short grain veneer direction
- base CC8NRC2-21156
- plinth base
- top is 1 1/4" thick and in two sections
- laminate worksurface, no charge if standard laminate is selected
- glass worksurface with reverse bevel edge, (see page 74) call for quote
- aluminum edge available, specify and add \$4,137 list

Rectangular Table with Rectangular Base	CC8JRR2-48168	48	168	29	12	2	3	567	32	\$14,877
---	----------------------	----	-----	----	----	---	---	-----	----	----------

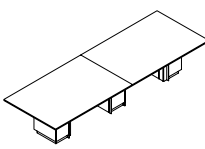

- short grain veneer direction
- base CC8NRC2-21132
- plinth base
- top is 1 1/4" thick and in two sections
- laminate worksurface, no charge if standard laminate is selected
- glass worksurface with reverse bevel edge, (see page 74) call for quote
- aluminum edge available, specify and add \$3,725 list

Rectangular Table with Rectangular Base	CC8JRR2-48144	48	144	29	8	2	3	525	30	\$13,746
---	----------------------	----	-----	----	---	---	---	-----	----	----------

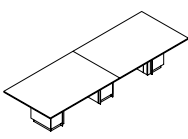

- short grain veneer direction
- base CC8NRC2-21108
- plinth base
- top is 1 1/4" thick and in two sections
- laminate worksurface, no charge if standard laminate is selected
- glass worksurface with reverse bevel edge, (see page 74) call for quote
- aluminum edge available, specify and add \$3,310 list

COLLECTIVE CONFERENCE

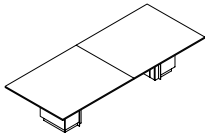
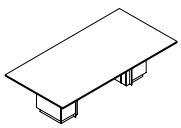
Description	① Model	D	L	H	Seat Capacity	Top Pieces	Bases Required	CTN WT	CU FT	List Price
Rectangular Table with Rectangular Base 	CC8JRR2-48120	48	120	29	6	2	2	393	22	\$8,961
	<ul style="list-style-type: none"> · short grain veneer direction · base CC8NRC2-2184 · plinth base · top is 1 1/4" thick and in two sections · laminate worksurface, no charge if standard laminate is selected · glass worksurface with reverse bevel edge, (see page 74) call for quote · aluminum edge available, specify and add \$2,897 list 									
Rectangular Table with Rectangular Base 	CC8JRR2-4896	48	96	29	6	1	2	355	20	\$7,694
	<ul style="list-style-type: none"> · long grain veneer direction · base CC8NRC2-2160 · plinth base · top is 1 1/4" thick · laminate worksurface, no charge if standard laminate is selected · glass worksurface with reverse bevel edge, (see page 74) call for quote · aluminum edge available, specify and add \$2,483 list 									

To Order, Specify:

- ① Model Number
- ② Wood Species
- ③ Finish Scheme
 - A. Accent Surround - Veneer or Paint
 - B. Base Pedestal - Veneer or Paint
 - (see page 78 - apron follows base pedestal)
- ④ Worksurface Option
 - A. Veneer
 - B. Laminate
 - C. White Back Painted Glass - Glossy
 - D. White Back Painted Glass - Frosted
 - (see page 74)
- ⑤ Power and Data Options (see page 322)
- ⑥ Other Product Options

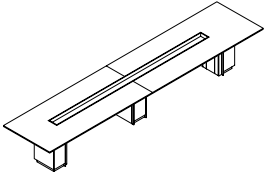
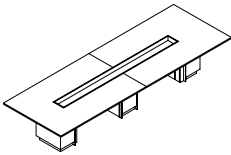
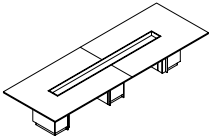
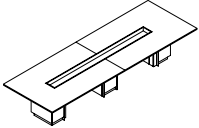
Description	① Model	D	L	H	Seat Capacity	Top Pieces	Bases Required	CTN WT	CU FT	List Price
Rectangular Table with Rectangular Base and Center Console 	CC8JRRM-48216	48	216	29	18	2	3	654	43	\$26,576
	<ul style="list-style-type: none"> · short grain veneer direction · base CC8NRC2-21174 · plinth base · top is 1 1/4" thick and in two sections · anodized aluminum center console 120" long · laminate worksurface, no charge if standard laminate is selected · glass worksurface with reverse bevel edge, (see page 74) call for quote · aluminum edge available, specify and add \$4,551 list 									
Rectangular Table with Rectangular Base and Center Console 	CC8JRRM-48192	48	192	29	16	2	3	612	40	\$20,887
	<ul style="list-style-type: none"> · short grain veneer direction · base CC8NRC2-21156 · plinth base · top is 1 1/4" thick and in two sections · anodized aluminum center console 144" long · laminate worksurface, no charge if standard laminate is selected · glass worksurface with reverse bevel edge, (see page 74) call for quote · aluminum edge available, specify and add \$4,137 list 									
Rectangular Table with Rectangular Base and Center Console 	CC8JRRM-48168	48	168	29	14	2	3	568	37	\$18,692
	<ul style="list-style-type: none"> · short grain veneer direction · base CC8NRC2-21132 · plinth base · top is 1 1/4" thick and in two sections · anodized aluminum center console 120" long · laminate worksurface, no charge if standard laminate is selected · glass worksurface with reverse bevel edge, (see page 74) call for quote · aluminum edge available, specify and add \$3,725 list 									
Rectangular Table with Rectangular Base and Center Console 	CC8JRRM-48144	48	144	29	10	2	3	525	34	\$16,844
	<ul style="list-style-type: none"> · short grain veneer direction · base CC8NRC2-21108 · plinth base · top is 1 1/4" thick and in two sections · anodized aluminum center console 96" long · laminate worksurface, no charge if standard laminate is selected · glass worksurface with reverse bevel edge, (see page 74) call for quote · aluminum edge available, specify and add \$3,310 list 									

COLLECTIVE CONFERENCE

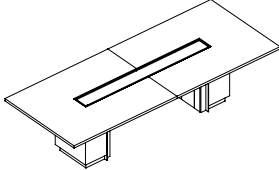
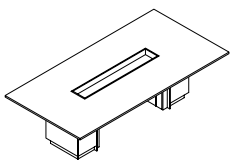
Description	① Model	D	L	H	Seat Capacity	Top Pieces	Bases Required	CTN WT	CU FT	List Price
Rectangular Table with Rectangular Base and Center Console 	CC8JRRM-48120	48	120	29	6	2	2	394	26	\$11,345
	<ul style="list-style-type: none"> · short grain veneer direction · base CC8NRC2-2184 · plinth base · top is 1 1/4" thick and in two sections · anodized aluminum center console 72" long · laminate worksurface, no charge if standard laminate is selected · glass worksurface with reverse bevel edge, (see page 74) call for quote · aluminum edge available, specify and add \$2,897 list 									
Rectangular Table with Rectangular Base and Center Console 	CC8JRRM-4896	48	96	29	6	1	2	355	23	\$9,363
	<ul style="list-style-type: none"> · long grain veneer direction · base CC8NRC2-2160 · plinth base · top is 1 1/4" thick · anodized aluminum center console 48" long · laminate worksurface, no charge if standard laminate is selected · glass worksurface with reverse bevel edge, (see page 74) call for quote · aluminum edge available, specify and add \$2,483 list 									

To Order, Specify:

- ① Model Number
- ② Wood Species
- ③ Finish Scheme
 - A. Accent Surround - Veneer or Paint
 - B. Base Pedestal - Veneer or Paint
(see page 78 - apron follows base pedestal)
- ④ Worksurface Option
 - A. Veneer
 - B. Laminate
 - C. White Back Painted Glass - Glossy
 - D. White Back Painted Glass - Frosted
(see page 74)
- ⑤ Power and Data Options (see page 322)
- ⑥ Other Product Options
- ⑦ Center Console Accessories (see pages 156–157 - order separately)

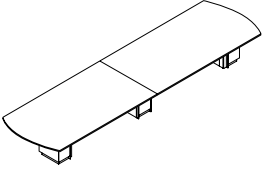
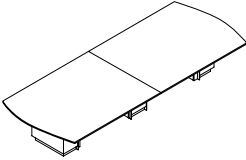
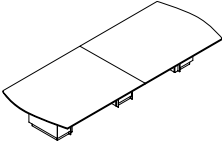
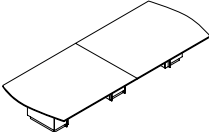
Description	① Model	D	L	H	Seat Capacity	Top Pieces	Bases Required	CTN WT	CU FT	List Price
Arc End Table with Rectangular Base 	CC8JAR2-60216	60	216	29	16	2	3	787	42	\$25,709
	<ul style="list-style-type: none"> · short grain veneer direction · base CC8NRC2-27174 · plinth base · top is 1 1/4" thick and in two sections · laminate worksurface, no charge if standard laminate is selected · glass worksurface with reverse bevel edge, (see page 74) call for quote 									
Arc End Table with Rectangular Base 	CC8JAR2-60192	60	192	29	14	2	3	737	39	\$20,004
	<ul style="list-style-type: none"> · short grain veneer direction · base CC8NRC2-27156 · plinth base · top is 1 1/4" thick and in two sections · laminate worksurface, no charge if standard laminate is selected · glass worksurface with reverse bevel edge, (see page 74) call for quote 									
Arc End Table with Rectangular Base 	CC8JAR2-60168	60	168	29	12	2	3	683	36	\$18,108
	<ul style="list-style-type: none"> · short grain veneer direction · base CC8NRC2-27132 · plinth base · top is 1 1/4" thick and in two sections · laminate worksurface, no charge if standard laminate is selected · glass worksurface with reverse bevel edge, (see page 74) call for quote 									
Arc End Table with Rectangular Base 	CC8JAR2-60144	60	144	29	10	2	3	632	33	\$16,578
	<ul style="list-style-type: none"> · short grain veneer direction · base CC8NRC2-27108 · plinth base · top is 1 1/4" thick and in two sections · laminate worksurface, no charge if standard laminate is selected · glass worksurface with reverse bevel edge, (see page 74) call for quote 									

COLLECTIVE CONFERENCE

Description	① Model	D	L	H	Seat Capacity	Top Pieces	Bases Required	CTN WT	CU FT	List Price
-------------	---------	---	---	---	---------------	------------	----------------	--------	-------	------------

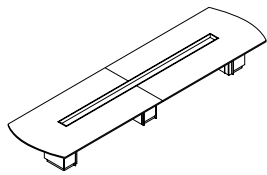

- short grain veneer direction
- base CC8NRC2-27174
- plinth base
- top is 1 1/4" thick and in two sections
- anodized aluminum center console 160" long
- laminate worksurface, no charge if standard laminate is selected
- glass worksurface with reverse bevel edge, (see page 74) call for quote

Arc End Table with Rectangular Base and Center Console

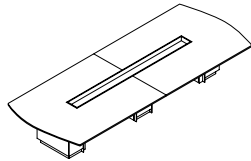

- | Description | ① Model | D | L | H | Seat Capacity | Top Pieces | Bases Required | CTN WT | CU FT | List Price |
|---|----------------------|----|-----|----|---------------|------------|----------------|--------|-------|------------|
| Arc End Table with Rectangular Base and Center Console | CC8JARM-60192 | 60 | 192 | 29 | 14 | 2 | 3 | 737 | 46 | \$24,534 |
- short grain veneer direction
 - base CC8NRC2-27156
 - plinth base
 - top is 1 1/4" thick and in two sections
 - anodized aluminum center console 144" long
 - laminate worksurface, no charge if standard laminate is selected
 - glass worksurface with reverse bevel edge, (see page 74) call for quote

Arc End Table with Rectangular Base and Center Console

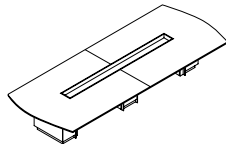

- | Description | ① Model | D | L | H | Seat Capacity | Top Pieces | Bases Required | CTN WT | CU FT | List Price |
|---|----------------------|----|-----|----|---------------|------------|----------------|--------|-------|------------|
| Arc End Table with Rectangular Base and Center Console | CC8JARM-60168 | 60 | 168 | 29 | 12 | 2 | 3 | 684 | 42 | \$21,921 |
- short grain veneer direction
 - base CC8NRC2-27132
 - plinth base
 - top is 1 1/4" thick and in two sections
 - anodized aluminum center console 120" long
 - laminate worksurface, no charge if standard laminate is selected
 - glass worksurface with reverse bevel edge, (see page 74) call for quote

Arc End Table with Rectangular Base and Center Console

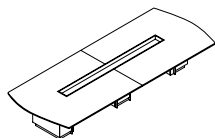

- | Description | ① Model | D | L | H | Seat Capacity | Top Pieces | Bases Required | CTN WT | CU FT | List Price |
|---|----------------------|----|-----|----|---------------|------------|----------------|--------|-------|------------|
| Arc End Table with Rectangular Base and Center Console | CC8JARM-60144 | 60 | 144 | 29 | 10 | 2 | 3 | 632 | 39 | \$19,676 |
- short grain veneer direction
 - base CC8NRC2-27108
 - plinth base
 - top is 1 1/4" thick and in two sections
 - anodized aluminum center console 96" long
 - laminate worksurface, no charge if standard laminate is selected
 - glass worksurface with reverse bevel edge, (see page 74) call for quote

To Order, Specify:

Arc End Table

- ① Model Number
- ② Wood Species
- ③ Finish Scheme
 - A. Accent Surround - Veneer or Paint
 - B. Base Pedestal - Veneer or Paint
(see page 78 - apron follows base pedestal)
- ④ Worksurface Option
 - A. Veneer
 - B. Laminate
 - C. White Back Painted Glass - Glossy
 - D. White Back Painted Glass - Frosted
(see page 74)
- ⑤ Power and Data Options (see page 322)
- ⑥ Other Product Options

Arc End Table with Center Console

- ① Model Number
- ② Wood Species
- ③ Finish Scheme
 - A. Accent Surround - Veneer or Paint
 - B. Base Pedestal - Veneer or Paint
(see page 78 - apron follows base pedestal)
- ④ Worksurface Option
 - A. Veneer
 - B. Laminate
 - C. White Back Painted Glass - Glossy
 - D. White Back Painted Glass - Frosted
(see page 74)
- ⑤ Power and Data Options (see page 322)
- ⑥ Other Product Options
- ⑦ Center Console Accessories (see pages 156-157 - order separately)

Description	① Model	D	L	H	Seat Capacity	Top Pieces	Bases Required	CTN WT	CU FT	List Price
Arc End Table with Rectangular Base 	CC8JAR2-48216	48	216	29	16	2	3	654	37	\$21,835
	<ul style="list-style-type: none"> · short grain veneer direction · base CC8NRC2-21174 · plinth base · top is 1 ¼" thick and in two sections · laminate worksurface, no charge if standard laminate is selected · glass worksurface with reverse bevel edge, (see page 74) call for quote 									
Arc End Table with Rectangular Base 	CC8JAR2-48192	48	192	29	14	2	3	612	35	\$16,796
	<ul style="list-style-type: none"> · short grain veneer direction · base CC8NRC2-21156 · plinth base · top is 1 ¼" thick and in two sections · laminate worksurface, no charge if standard laminate is selected · glass worksurface with reverse bevel edge, (see page 74) call for quote 									
Arc End Table with Rectangular Base 	CC8JAR2-48168	48	168	29	12	2	3	567	32	\$15,254
	<ul style="list-style-type: none"> · short grain veneer direction · base CC8NRC2-21132 · plinth base · top is 1 ¼" thick and in two sections · laminate worksurface, no charge if standard laminate is selected · glass worksurface with reverse bevel edge, (see page 74) call for quote 									
Arc End Table with Rectangular Base 	CC8JAR2-48144	48	144	29	10	2	3	525	30	\$14,058
	<ul style="list-style-type: none"> · short grain veneer direction · base CC8NRC2-21108 · plinth base · top is 1 ¼" thick and in two sections · laminate worksurface, no charge if standard laminate is selected · glass worksurface with reverse bevel edge, (see page 74) call for quote 									

COLLECTIVE CONFERENCE

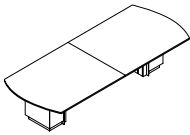
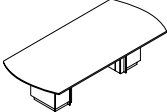
Description	① Model	D	L	H	Seat Capacity	Top Pieces	Bases Required	CTN WT	CU FT	List Price
Arc End Table with Rectangular Base 	CC8JAR2-48120	48	120	29	6	2	2	393	22	\$9,215
	<ul style="list-style-type: none"> · short grain veneer direction · base CC8NRC2-2184 · plinth base · top is 1 1/4" thick and in two sections · laminate worksurface, no charge if standard laminate is selected · glass worksurface with reverse bevel edge, (see page 74) call for quote 									
Arc End Table with Rectangular Base 	CC8JAR2-4896	48	96	29	6	1	2	355	20	\$7,880
	<ul style="list-style-type: none"> · long grain veneer direction · base CC8NRC2-2160 · plinth base · top is 1 1/4" thick · laminate worksurface, no charge if standard laminate is selected · glass worksurface with reverse bevel edge, (see page 74) call for quote 									

To Order, Specify

- ① Model Number
- ② Wood Species
- ③ Finish Scheme
 - A. Accent Surround - Veneer or Paint
 - B. Base Pedestal - Veneer or Paint
(see page 78 - apron follows base pedestal)
- ④ Worksurface Option
 - A. Veneer
 - B. Laminate
 - C. White Back Painted Glass - Glossy
 - D. White Back Painted Glass - Frosted
(see page 74)
- ⑤ Power and Data Options (see page 322)
- ⑥ Other Product Options

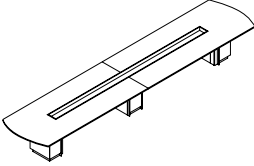
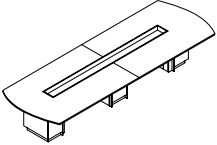
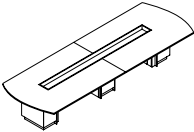
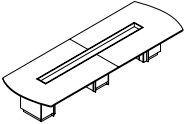
Description	① Model	D	L	H	Seat Capacity	Top Pieces	Bases Required	CTN WT	CU FT	List Price
Arc End Table with Rectangular Base and Center Console 	CC8JARM-48216	48	216	29	16	2	3	654	43	\$27,079
	<ul style="list-style-type: none"> · short grain veneer direction · base CC8NRC2-21174 · plinth base · top is 1 1/4" thick and in two sections · anodized aluminum center console 160" long · laminate worksurface, no charge if standard laminate is selected · glass worksurface with reverse bevel edge, (see page 74) call for quote 									
Arc End Table with Rectangular Base and Center Console 	CC8JARM-48192	48	192	29	14	2	3	612	40	\$21,326
	<ul style="list-style-type: none"> · short grain veneer direction · base CC8NRC2-21156 · plinth base · top is 1 1/4" thick and in two sections · anodized aluminum center console 144" long · laminate worksurface, no charge if standard laminate is selected · glass worksurface with reverse bevel edge, (see page 74) call for quote 									
Arc End Table with Rectangular Base and Center Console 	CC8JARM-48168	48	168	29	12	2	3	568	37	\$19,066
	<ul style="list-style-type: none"> · short grain veneer direction · base CC8NRC2-21132 · plinth base · top is 1 1/4" thick and in two sections · anodized aluminum center console 120" long · laminate worksurface, no charge if standard laminate is selected · glass worksurface with reverse bevel edge, (see page 74) call for quote 									
Arc End Table with Rectangular Base and Center Console 	CC8JARM-48144	48	144	29	10	2	3	525	34	\$17,157
	<ul style="list-style-type: none"> · short grain veneer direction · base CC8NRC2-21108 · plinth base · top is 1 1/4" thick and in two sections · anodized aluminum center console 96" long · laminate worksurface, no charge if standard laminate is selected · glass worksurface with reverse bevel edge, (see page 74) call for quote 									

COLLECTIVE CONFERENCE

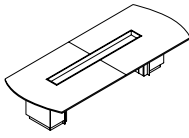
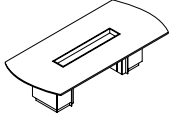
Description	① Model	D	L	H	Seat Capacity	Top Pieces	Bases Required	CTN WT	CU FT	List Price
Arc End Table with Rectangular Base and Center Console 	CC8JARM-48120	48	120	29	6	2	2	394	26	\$11,599
	<ul style="list-style-type: none"> · short grain veneer direction · base CC8NRC2-2184 · plinth base · top is 1 1/4" thick and in two sections · anodized aluminum center console 72" long · laminate worksurface, no charge if standard laminate is selected · glass worksurface with reverse bevel edge, (see page 74) call for quote 									
Arc End Table with Rectangular Base and Center Console 	CC8JARM-4896	48	96	29	6	1	2	355	23	\$9,548
	<ul style="list-style-type: none"> · long grain veneer direction · base CC8NRC2-2160 · plinth base · top is 1 1/4" thick · anodized aluminum center console 48" long · laminate worksurface, no charge if standard laminate is selected · glass worksurface with reverse bevel edge, (see page 74) call for quote 									

To Order, Specify

- ① Model Number
- ② Wood Species
- ③ Finish Scheme
 - A. Accent Surround - Veneer or Paint
 - B. Base Pedestal - Veneer or Paint
(see page 78 - apron follows base pedestal)
- ④ Worksurface Option
 - A. Veneer
 - B. Laminate
 - C. White Back Painted Glass - Glossy
 - D. White Back Painted Glass - Frosted
(see page 74)
- ⑤ Power and Data Options (see page 322)
- ⑥ Other Product Options
- ⑦ Center Console Accessories (see pages 156-157 - order separately)

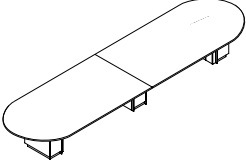
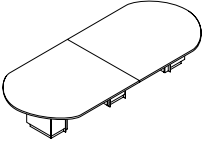
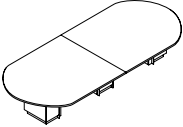
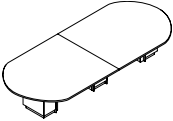
Description	① Model	D	L	H	Seat Capacity	Top Pieces	Bases Required	CTN WT	CU FT	List Price
Racetrack Table with Rectangular Base 	CC8JOR2-60216	60	216	29	18	2	3	762	42	\$25,926
	<ul style="list-style-type: none"> · short grain veneer direction · base CC8NRC2-27174 · plinth base · top is 1 ¼" thick and in two sections · laminate worksurface, no charge if standard laminate is selected · glass worksurface with reverse bevel edge, (see page 74) call for quote 									
Racetrack Table with Rectangular Base 	CC8JOR2-60192	60	192	29	16	2	3	712	39	\$20,196
	<ul style="list-style-type: none"> · short grain veneer direction · base CC8NRC2-27156 · plinth base · top is 1 ¼" thick and in two sections · laminate worksurface, no charge if standard laminate is selected · glass worksurface with reverse bevel edge, (see page 74) call for quote 									
Racetrack Table with Rectangular Base 	CC8JOR2-60168	60	168	29	14	2	3	658	36	\$18,268
	<ul style="list-style-type: none"> · short grain veneer direction · base CC8NRC2-27132 · plinth base · top is 1 ¼" thick and in two sections · laminate worksurface, no charge if standard laminate is selected · glass worksurface with reverse bevel edge, (see page 74) call for quote 									
Racetrack Table with Rectangular Base 	CC8JOR2-60144	60	144	29	10	2	3	607	33	\$16,713
	<ul style="list-style-type: none"> · short grain veneer direction · base CC8NRC2-27108 · plinth base · top is 1 ¼" thick and in two sections · laminate worksurface, no charge if standard laminate is selected · glass worksurface with reverse bevel edge, (see page 74) call for quote 									

COLLECTIVE CONFERENCE

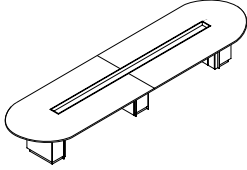
Description	Model	D	L	H	Seat Capacity	Top Pieces	Bases Required	CTN WT	CU FT	List Price
Racetrack Table with Rectangular Base and Center Console 	CC8JORM-60216	60	216	29	18	2	3	763	50	\$31,169
<ul style="list-style-type: none"> · short grain veneer direction · base CC8NRC2-27174 · plinth base · top is 1 1/4" thick and in two sections · anodized aluminum center console 160" long · laminate worksurface, no charge if standard laminate is selected · glass worksurface with reverse bevel edge, (see page 74) call for quote 										

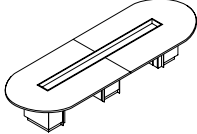
Racetrack Table with Rectangular Base and Center Console 	CC8JORM-60192	60	192	29	16	2	3	712	46	\$24,723
<ul style="list-style-type: none"> · short grain veneer direction · base CC8NRC2-27156 · plinth base · top is 1 1/4" thick and in two sections · anodized aluminum center console 144" long · laminate worksurface, no charge if standard laminate is selected · glass worksurface with reverse bevel edge, (see page 74) call for quote 										

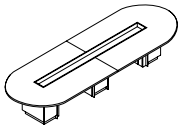
Racetrack Table with Rectangular Base and Center Console 	CC8JORM-60168	60	168	29	14	2	3	659	42	\$22,082
<ul style="list-style-type: none"> · short grain veneer direction · base CC8NRC2-27132 · plinth base · top is 1 1/4" thick and in two sections · anodized aluminum center console 120" long · laminate worksurface, no charge if standard laminate is selected · glass worksurface with reverse bevel edge, (see page 74) call for quote 										

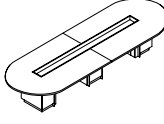
Racetrack Table with Rectangular Base and Center Console 	CC8JORM-60144	60	144	29	10	2	3	607	39	\$19,812
<ul style="list-style-type: none"> · short grain veneer direction · base CC8NRC2-27108 · plinth base · top is 1 1/4" thick and in two sections · anodized aluminum center console 96" long · laminate worksurface, no charge if standard laminate is selected · glass worksurface with reverse bevel edge, (see page 74) call for quote 										

To Order, Specify:

Racetrack Table

- 1 Model Number
- 2 Wood Species
- 3 Finish Scheme
 - A. Accent Surround - Veneer or Paint
 - B. Base Pedestal - Veneer or Paint
 (see page 78 - apron follows base pedestal)
- 4 Worksurface Option
 - A. Veneer
 - B. Laminate
 - C. White Back Painted Glass - Glossy
 - D. White Back Painted Glass - Frosted
 (see page 74)
- 5 Power and Data Options (see page 322)
- 6 Other Product Options

Racetrack Table with Center Console

- 1 Model Number
- 2 Wood Species
- 3 Finish Scheme
 - A. Accent Surround - Veneer or Paint
 - B. Base Pedestal - Veneer or Paint
 (see page 78 - apron follows base pedestal)
- 4 Worksurface Option
 - A. Veneer
 - B. Laminate
 - C. White Back Painted Glass - Glossy
 - D. White Back Painted Glass - Frosted
 (see page 74)
- 5 Power and Data Options (see page 322)
- 6 Other Product Options
- 7 Center Console Accessories (see pages 156-157 - order separately)

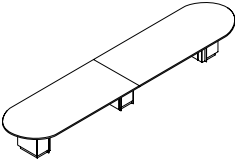
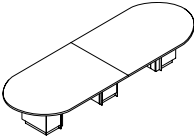
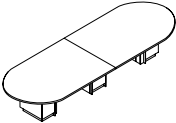
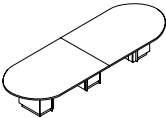
Description	① Model	D	L	H	Seat Capacity	Top Pieces	Bases Required	CTN WT	CU FT	List Price
Racetrack Table with Rectangular Base 	CC8JOR2-48216	48	216	29	16	2	3	646	37	\$22,003
	<ul style="list-style-type: none"> · short grain veneer direction · base CC8NRC2-21174 · plinth base · top is 1 ¼" thick and in two sections · laminate worksurface, no charge if standard laminate is selected · glass worksurface with reverse bevel edge, (see page 74) call for quote 									
Racetrack Table with Rectangular Base 	CC8JOR2-48192	48	192	29	14	2	3	596	35	\$16,942
	<ul style="list-style-type: none"> · short grain veneer direction · base CC8NRC2-21156 · plinth base · top is 1 ¼" thick and in two sections · laminate worksurface, no charge if standard laminate is selected · glass worksurface with reverse bevel edge, (see page 74) call for quote 									
Racetrack Table with Rectangular Base 	CC8JOR2-48168	48	168	29	12	2	3	560	32	\$15,377
	<ul style="list-style-type: none"> · short grain veneer direction · base CC8NRC2-21132 · plinth base · top is 1 ¼" thick and in two sections · laminate worksurface, no charge if standard laminate is selected · glass worksurface with reverse bevel edge, (see page 74) call for quote 									
Racetrack Table with Rectangular Base 	CC8JOR2-48144	48	144	29	8	2	3	509	30	\$14,164
	<ul style="list-style-type: none"> · short grain veneer direction · base CC8NRC2-21108 · plinth base · top is 1 ¼" thick and in two sections · laminate worksurface, no charge if standard laminate is selected · glass worksurface with reverse bevel edge, (see page 74) call for quote 									

COLLECTIVE CONFERENCE

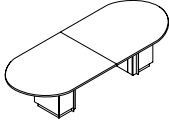
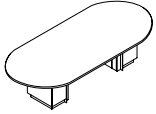
Description	① Model	D	L	H	Seat Capacity	Top Pieces	Bases Required	CTN WT	CU FT	List Price
Racetrack Table with Rectangular Base 	CC8JOR2-48120	48	120	29	6	2	2	377	22	\$9,300
	<ul style="list-style-type: none"> · short grain veneer direction · base CC8NRC2-2184 · plinth base · top is 1 1/4" thick and in two sections · laminate worksurface, no charge if standard laminate is selected · glass worksurface with reverse bevel edge, (see page 74) call for quote 									
Racetrack Table with Rectangular Base 	CC8JOR2-4896	48	96	29	6	1	2	330	20	\$7,942
	<ul style="list-style-type: none"> · long grain veneer direction · base CC8NRC2-2160 · plinth base · top is 1 1/4" thick · laminate worksurface, no charge if standard laminate is selected · glass worksurface with reverse bevel edge, (see page 74) call for quote 									

To Order, Specify:

- ① Model Number
- ② Wood Species
- ③ Finish Scheme
 - A. Accent Surround - Veneer or Paint
 - B. Base Pedestal - Veneer or Paint
 (see page 78 - apron follows base pedestal)
- ④ Worksurface Option
 - A. Veneer
 - B. Laminate
 - C. White Back Painted Glass - Glossy
 - D. White Back Painted Glass - Frosted
 (see page 74)
- ⑤ Power and Data Options (see page 322)
- ⑥ Other Product Options

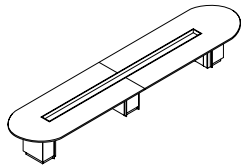
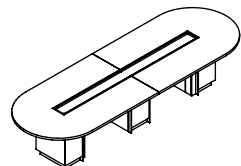
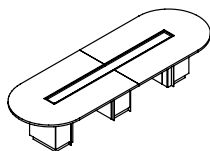
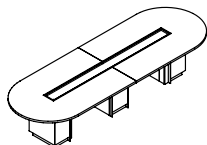
Description	① Model	D	L	H	Seat Capacity	Top Pieces	Bases Required	CTN WT	CU FT	List Price
Racetrack Table with Rectangular Base and Center Console 	CC8JORM-48216	48	216	29	18	2	3	646	43	\$27,246
	<ul style="list-style-type: none"> · short grain veneer direction · base CC8NRC2-21174 · plinth base · top is 1 1/4" thick and in two sections · anodized aluminum center console 160" long · laminate worksurface, no charge if standard laminate is selected · glass worksurface with reverse bevel edge, (see page 74) call for quote 									
Racetrack Table with Rectangular Base and Center Console 	CC8JORM-48192	48	192	29	16	2	3	597	40	\$21,471
	<ul style="list-style-type: none"> · short grain veneer direction · base CC8NRC2-21156 · plinth base · top is 1 1/4" thick and in two sections · anodized aluminum center console 144" long · laminate worksurface, no charge if standard laminate is selected · glass worksurface with reverse bevel edge, (see page 74) call for quote 									
Racetrack Table with Rectangular Base and Center Console 	CC8JORM-48168	48	168	29	14	2	3	560	37	\$19,191
	<ul style="list-style-type: none"> · short grain veneer direction · base CC8NRC2-21132 · plinth base · top is 1 1/4" thick and in two sections · anodized aluminum center console 120" long · laminate worksurface, no charge if standard laminate is selected · glass worksurface with reverse bevel edge, (see page 74) call for quote 									
Racetrack Table with Rectangular Base and Center Console 	CC8JORM-48144	48	144	29	10	2	3	510	34	\$17,262
	<ul style="list-style-type: none"> · short grain veneer direction · base CC8NRC2-21108 · plinth base · top is 1 1/4" thick and in two sections · anodized aluminum center console 96" long · laminate worksurface, no charge if standard laminate is selected · glass worksurface with reverse bevel edge, (see page 74) call for quote 									

COLLECTIVE CONFERENCE

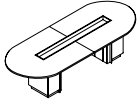
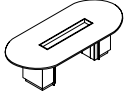
Description	① Model	D	L	H	Seat Capacity	Top Pieces	Bases Required	CTN WT	CU FT	List Price
Racetrack Table with Rectangular Base and Center Console 	CC8JORM-48120	48	120	29	6	2	2	378	26	\$11,685
	<ul style="list-style-type: none"> · short grain veneer direction · base CC8NRC2-2184 · plinth base · top is 1 1/4" thick and in two sections · anodized aluminum center console 72" long · laminate worksurface, no charge if standard laminate is selected · glass worksurface with reverse bevel edge, (see page 74) call for quote 									
Racetrack Table with Rectangular Base and Center Console 	CC8JORM-4896	48	96	29	6	1	2	331	23	\$9,609
	<ul style="list-style-type: none"> · long grain veneer direction · base CC8NRC2-2160 · plinth base · top is 1 1/4" thick · anodized aluminum center console 48" long · laminate worksurface, no charge if standard laminate is selected · glass worksurface with reverse bevel edge, (see page 74) call for quote 									

To Order, Specify:

- ① Model Number
- ② Wood Species
- ③ Finish Scheme
 - A. Accent Surround - Veneer or Paint
 - B. Base Pedestal - Veneer or Paint
(see page 78 - apron follows base pedestal)
- ④ Worksurface Option
 - A. Veneer
 - B. Laminate
 - C. White Back Painted Glass - Glossy
 - D. White Back Painted Glass - Frosted
(see page 74)
- ⑤ Power and Data Options (see page 322)
- ⑥ Other Product Options
- ⑦ Center Console Accessories (see pages 156–157 - order separately)

Description	① Model	D	L	H	Seat Capacity	Top Pieces	Bases Required	CTN WT	CU FT	List Price
-------------	---------	---	---	---	---------------	------------	----------------	--------	-------	------------

Boat Shape Table with Rectangular Base

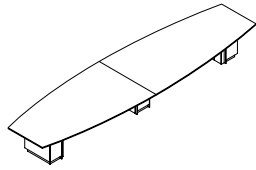

CC8JBR2-60216	60	216	29	16	2	3	710	42	\$25,119
----------------------	----	-----	----	----	---	---	-----	----	----------

- short grain veneer direction
- base CC8NRC2-27174
- plinth base
- top is 1 ¼" thick and in two sections
- laminate worksurface, no charge if standard laminate is selected
- glass worksurface with reverse bevel edge, (see page 74) call for quote

Boat Shape Table with Rectangular Base

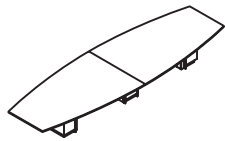

CC8JBR2-60192	60	192	29	14	2	3	668	39	\$19,262
----------------------	----	-----	----	----	---	---	-----	----	----------

- short grain veneer direction
- base CC8NRC2-27156
- plinth base
- top is 1 ¼" thick and in two sections
- laminate worksurface, no charge if standard laminate is selected
- glass worksurface with reverse bevel edge, (see page 74) call for quote

Boat Shape Table with Rectangular Base

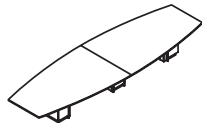

CC8JBR2-60168	60	168	29	12	2	3	623	36	\$17,773
----------------------	----	-----	----	----	---	---	-----	----	----------

- short grain veneer direction
- base CC8NRC2-27132
- plinth base
- top is 1 ¼" thick and in two sections
- laminate worksurface, no charge if standard laminate is selected
- glass worksurface with reverse bevel edge, (see page 74) call for quote

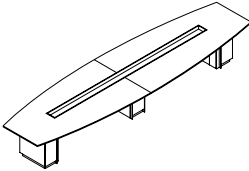
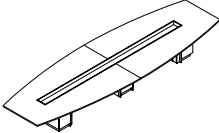
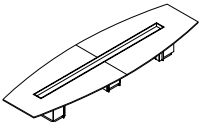
Description	Model	D	L	H	Seat Capacity	Top Pieces	Bases Required	CTN WT	CU FT	List Price
Boat Shape Table with Rectangular Base and Center Console 	CC8JBRM-60216	60	216	29	16	2	3	711	50	\$30,363
	<ul style="list-style-type: none"> · short grain veneer direction · base CC8NRC2-27174 · plinth base · top is 1 1/4" thick and in two sections · anodized aluminum center console 160" long · laminate worksurface, no charge if standard laminate is selected · glass worksurface with reverse bevel edge, (see page 74) call for quote 									
Boat Shape Table with Rectangular Base and Center Console 	CC8JBRM-60192	60	192	29	14	2	3	668	46	\$23,790
	<ul style="list-style-type: none"> · short grain veneer direction · base CC8NRC2-27156 · plinth base · top is 1 1/4" thick and in two sections · anodized aluminum center console 144" long · laminate worksurface, no charge if standard laminate is selected · glass worksurface with reverse bevel edge, (see page 74) call for quote 									
Boat Shape Table with Rectangular Base and Center Console 	CC8JBRM-60168	60	168	29	12	2	3	624	42	\$21,585
	<ul style="list-style-type: none"> · short grain veneer direction · base CC8NRC2-27132 · plinth base · top is 1 1/4" thick and in two sections · anodized aluminum center console 120" long · laminate worksurface, no charge if standard laminate is selected · glass worksurface with reverse bevel edge, (see page 74) call for quote 									

To Order, Specify:

Boat Shape Table

- ① Model Number
- ② Wood Species
- ③ Finish Scheme
 - A. Accent Surround - Veneer or Paint
 - B. Base Pedestal - Veneer or Paint
 (see page 78 - apron follows base pedestal)
- ④ Worksurface Option
 - A. Veneer
 - B. Laminate
 - C. White Back Painted Glass - Glossy
 - D. White Back Painted Glass - Frosted
 (see page 74)
- ⑤ Power and Data Options (see page 322)
- ⑥ Other Product Options

Boat Shape Table with Center Console

- ① Model Number
- ② Wood Species
- ③ Finish Scheme
 - A. Accent Surround - Veneer or Paint
 - B. Base Pedestal - Veneer or Paint
 (see page 78 - apron follows base pedestal)
- ④ Worksurface Option
 - A. Veneer
 - B. Laminate
 - C. White Back Painted Glass - Glossy
 - D. White Back Painted Glass - Frosted
 (see page 74)
- ⑤ Power and Data Options (see page 322)
- ⑥ Other Product Options
- ⑦ Center Console Accessories (see pages 156-157 - order separately)

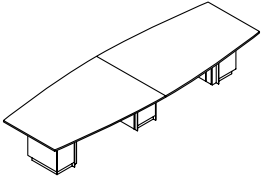
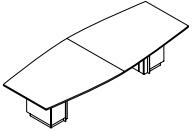
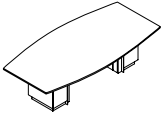
Description	① Model	D	L	H	Seat Capacity	Top Pieces	Bases Required	CTN WT	CU FT	List Price
Boat Shape Table with Rectangular Base 	CC8JBR2-48144	48	144	29	8	2	3	497	30	\$16,322
	<ul style="list-style-type: none"> · short grain veneer direction · base CC8NRC2-21108 · plinth base · top is 1 1/4" thick and in two sections · laminate worksurface, no charge if standard laminate is selected · glass worksurface with reverse bevel edge, (see page 74) call for quote 									
Boat Shape Table with Rectangular Base 	CC8JBR2-48120	48	120	29	6	2	2	370	22	\$10,341
	<ul style="list-style-type: none"> · short grain veneer direction · base CC8NRC2-2184 · plinth base · top is 1 1/4" thick and in two sections · laminate worksurface, no charge if standard laminate is selected · glass worksurface with reverse bevel edge, (see page 74) call for quote 									
Boat Shape Table with Rectangular Base 	CC8JBR2-4896	48	96	29	6	1	2	336	20	\$8,722
	<ul style="list-style-type: none"> · long grain veneer direction · base CC8NRC2-2160 · plinth base · top is 1 1/4" thick · laminate worksurface, no charge if standard laminate is selected · glass worksurface with reverse bevel edge, (see page 74) call for quote 									

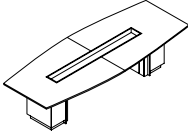
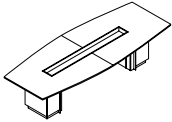
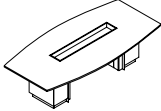
Description	① Model	D	L	H	Seat Capacity	Top Pieces	Bases Required	CTN WT	CU FT	List Price
Boat Shape Table with Rectangular Base and Center Console 	CC8JBRM-48144	48	144	29	8	2	3	498	34	\$19,419
	<ul style="list-style-type: none"> · short grain veneer direction · base CC8NRC2-21108 · plinth base · top is 1 1/4" thick and in two sections · anodized aluminum center console 96" long · laminate worksurface, no charge if standard laminate is selected · glass worksurface with reverse bevel edge, (see page 74) call for quote 									
Boat Shape Table with Rectangular Base and Center Console 	CC8JBRM-48120	48	120	29	6	2	2	371	26	\$12,723
	<ul style="list-style-type: none"> · short grain veneer direction · base CC8NRC2-2184 · plinth base · top is 1 1/4" thick and in two sections · anodized aluminum center console 72" long · laminate worksurface, no charge if standard laminate is selected · glass worksurface with reverse bevel edge, (see page 74) call for quote 									
Boat Shape Table with Rectangular Base and Center Console 	CC8JBRM-4896	48	96	29	6	1	2	337	23	\$10,389
	<ul style="list-style-type: none"> · long grain veneer direction · base CC8NRC2-2160 · plinth base · top is 1 1/4" thick · anodized aluminum center console 48" long · laminate worksurface, no charge if standard laminate is selected · glass worksurface with reverse bevel edge, (see page 74) call for quote 									

To Order, Specify:

Boat Shape Table

- ① Model Number
- ② Wood Species
- ③ Finish Scheme
 - A. Accent Surround - Veneer or Paint
 - B. Base Pedestal - Veneer or Paint
 (see page 78 - apron follows base pedestal)
- ④ Worksurface Option
 - A. Veneer
 - B. Laminate
 - C. White Back Painted Glass - Glossy
 - D. White Back Painted Glass - Frosted
 (see page 74)
- ⑤ Power and Data Options (see page 322)
- ⑥ Other Product Options

Boat Shape Table with Center Console

- ① Model Number
- ② Wood Species
- ③ Finish Scheme
 - A. Accent Surround - Veneer or Paint
 - B. Base Pedestal - Veneer or Paint
 (see page 78 - apron follows base pedestal)
- ④ Worksurface Option
 - A. Veneer
 - B. Laminate
 - C. White Back Painted Glass - Glossy
 - D. White Back Painted Glass - Frosted
 (see page 74)
- ⑤ Power and Data Options (see page 322)
- ⑥ Other Product Options
- ⑦ Center Console Accessories (see pages 156-157 - order separately)

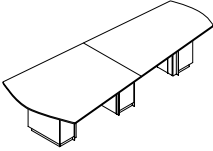
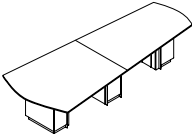
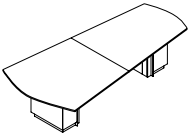
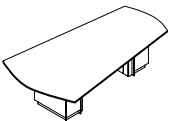
Description	① Model	D	L	H	Seat Capacity	Top Pieces	Bases Required	CTN WT	CU FT	List Price
View Table with Rectangular Base 	CC8JVR2-60168	60	168	29	12	2	3	629	36	\$19,907
	<ul style="list-style-type: none"> · short grain veneer direction · base CC8NRC9-27168 · plinth base · top is 1 1/4" thick and in two sections · laminate worksurface, no charge if standard laminate is selected · glass worksurface with reverse bevel edge, (see page 74) call for quote · top size: 168"w x 40/60"d 									
View Table with Rectangular Base 	CC8JVR2-60144	60	144	29	10	2	3	585	33	\$16,781
	<ul style="list-style-type: none"> · short grain veneer direction · base CC8NRC9-27144 · plinth base · top is 1 1/4" thick and in two sections · laminate worksurface, no charge if standard laminate is selected · glass worksurface with reverse bevel edge, (see page 74) call for quote · top size: 144"w x 40/60"d 									
View Table with Rectangular Base 	CC8JVR2-60120	60	120	29	9	2	2	424	25	\$10,682
	<ul style="list-style-type: none"> · short grain veneer direction · base CC8NRC9-27120 · plinth base · top is 1 1/4" thick and in two sections · laminate worksurface, no charge if standard laminate is selected · glass worksurface with reverse bevel edge, (see page 74) call for quote · top size: 120"w x 40/60"d 									
View Table with Rectangular Base 	CC8JVR2-6096	60	96	29	7	1	2	380	22	\$8,878
	<ul style="list-style-type: none"> · long grain veneer direction · base CC8NRC9-2796 · plinth base · top is 1 1/4" thick · laminate worksurface, no charge if standard laminate is selected · glass worksurface with reverse bevel edge, (see page 74) call for quote · top size: 96"w x 40/60"d 									

COLLECTIVE CONFERENCE

Description	① Model	D	L	H	Seat Capacity	Top Pieces	Bases Required	CTN WT	CU FT	List Price
View Table with Rectangular Base and Center Console	CC8JVRM-60168	60	168	29	11	2	3	630	42	\$23,720

- short grain veneer direction
- base CC8NRC9-27168
- plinth base
- top is 1 ¼" thick and in two sections
- anodized aluminum center console 120" long
- laminate worksurface, no charge if standard laminate is selected
- glass worksurface with reverse bevel edge, (see page 74) call for quote
- top size: 168"w x 40/60"d

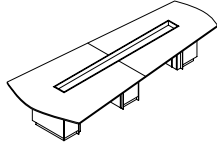

View Table with Rectangular Base and Center Console	CC8JVRM-60144	60	144	29	11	2	3	585	39	\$19,880
---	----------------------	----	-----	----	----	---	---	-----	----	----------

- short grain veneer direction
- base CC8NRC9-27144
- plinth base
- top is 1 ¼" thick and in two sections
- anodized aluminum center console 96" long
- laminate worksurface, no charge if standard laminate is selected
- glass worksurface with reverse bevel edge, (see page 74) call for quote
- top size: 144"w x 40/60"d

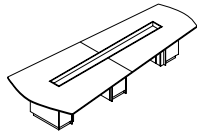

View Table with Rectangular Base and Center Console	CC8JVRM-60120	60	120	29	9	2	2	424	30	\$13,065
---	----------------------	----	-----	----	---	---	---	-----	----	----------

- short grain veneer direction
- base CC8NRC9-27120
- plinth base
- top is 1 ¼" thick and in two sections
- anodized aluminum center console 72" long
- laminate worksurface, no charge if standard laminate is selected
- glass worksurface with reverse bevel edge, (see page 74) call for quote
- top size: 120"w x 40/60"d

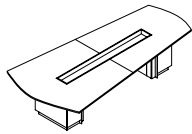

View Table with Rectangular Base and Center Console	CC8JVRM-6096	60	96	29	7	1	2	380	26	\$10,548
---	---------------------	----	----	----	---	---	---	-----	----	----------

- long grain veneer direction
- base CC8NRC9-2796
- plinth base
- top is 1 ¼" thick
- anodized aluminum center console 48" long
- laminate worksurface, no charge if standard laminate is selected
- glass worksurface with reverse bevel edge, (see page 74) call for quote
- top size: 96"w x 40/60"d

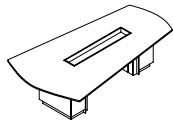

To Order, Specify:

View Table

- ① Model Number
- ② Wood Species
- ③ Finish Scheme
 - A. Accent Surround - Veneer or Paint
 - B. Base Pedestal - Veneer or Paint
(see page 78 - apron follows base pedestal)
- ④ Worksurface Option
 - A. Veneer
 - B. Laminate
 - C. White Back Painted Glass - Glossy
 - D. White Back Painted Glass - Frosted
(see page 74)
- ⑤ Power and Data Options (see page 322)
- ⑥ Other Product Options

View Table with Center Console

- ① Model Number
- ② Wood Species
- ③ Finish Scheme
 - A. Accent Surround - Veneer or Paint
 - B. Base Pedestal - Veneer or Paint
(see page 78 - apron follows base pedestal)
- ④ Worksurface Option
 - A. Veneer
 - B. Laminate
 - C. White Back Painted Glass - Glossy
 - D. White Back Painted Glass - Frosted
(see page 74)
- ⑤ Power and Data Options (see page 322)
- ⑥ Other Product Options
- ⑦ Center Console Accessories (see pages 156-157 - order separately)

Description	① Model	D	L	H	Seat Capacity	Top Pieces	Bases Required	CTN WT	CU FT	List Price
Glass Top with Column/Disc Base ▲ 	CC8JDDG-0048	48	48	29	3 to 4	1	1	175	20	\$6,287
	CC8JDDG-0042	42	42	29	3 to 4	1	1	154	19	\$5,719
	CC8JDDG-0036	36	36	29	3 to 4	1	1	136	18	\$5,195

- top is 1/2" tempered frosted glass underside
- 26" dia. disk base is Arctic Silver powder coated aluminum with veneer column

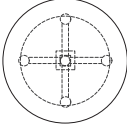

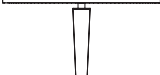
Veneer Top with Column/Disc Base ▲ 	CC8JDD1-0048	48	48	29	3 to 4	1	1	150	5	\$5,281
	CC8JDD1-0042	42	42	29	3 to 4	1	1	135	4	\$4,778
	CC8JDD1-0036	36	36	29	3 to 4	1	1	122	3	\$4,258
	CC8JDD1-0030	30	30	29	3 to 4	1	1	110	3	\$3,835

- 26" dia. disk base is Arctic Silver powder coated aluminum with veneer column
- laminate worksurface, no charge if standard laminate is selected

Description	① Model	D	L	H	Seat Capacity	Top Pieces	Bases Required	CTN WT	CU FT	List Price
Veneer Top with Cylinder Base ▲	CC8JDC1-0048	48	48	29	4	1	1	141	17	\$3,749
	CC8JDC1-0042	42	42	29	4	1	1	126	16	\$3,515

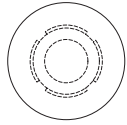
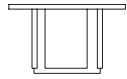

- 24" dia. base has 4 accent panels
- laminate worksurface, no charge if standard laminate is selected
- drum style construction

To Order, Specify:

Round Table with Column/Disc Base

- ① Model Number
- ② Wood Species
- ③ Finish Color

Round Table with Cylinder Disc

- ① Model Number
 - ② Wood Species
 - ③ Finish Scheme
 - A. Cylinder Base - Veneer or Paint
 - B. Accent Panel - Veneer or Paint
- (see page 79 - apron follows base pedestal)

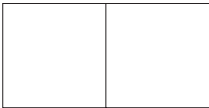
Description	① Model	W	L	H	Seat Capacity	Top Pieces	CTN WT	CU FT	List Price
Rectangular Top 	CC8CTR1-60216	60	216	1 ¼	18	2	460	25	\$11,125
	CC8CTR1-60192	60	192	1 ¼	16	2	409	23	\$9,685
	CC8CTR1-60168	60	168	1 ¼	14	2	358	20	\$8,288
	CC8CTR1-60144	60	144	1 ¼	10	2	308	17	\$6,940

- short grain veneer direction
- top is 1 ¼" thick and in two sections
- laminate worksurface, no charge if standard laminate is selected
- glass worksurface with reverse bevel edge, (see page 74) call for quote
- aluminum edge available, specify and add \$4,757 list for CC8CTR1-60216, \$4,345 list for CC8CTR1-60192, \$3,932 list for CC8CTR1-60168 and \$3,517 list for CC8CTR1-60144

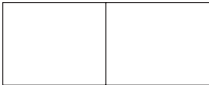
Rectangular Top 	CC8CTR1-48216	48	216	1 ¼	16	2	370	21	\$8,561
	CC8CTR1-48192	48	192	1 ¼	14	2	330	18	\$7,444
	CC8CTR1-48168	48	168	1 ¼	13	2	289	16	\$6,380
	CC8CTR1-48144	48	144	1 ¼	8	2	248	14	\$5,347
	CC8CTR1-48120	48	120	1 ¼	6	2	207	11	\$4,343

- short grain veneer direction
- top is 1 ¼" thick and in two sections
- laminate worksurface, no charge if standard laminate is selected
- glass worksurface with reverse bevel edge, (see page 74) call for quote
- aluminum edge available, specify and add \$4,551 list for CC8CTR1-48216, \$4,137 list for CC8CTR1-48192, \$3,725 list for CC8CTR1-48168, \$3,310 list for CC8CTR1-48144 and \$2,897 list for CC8CTR1-48120

Rectangular Top 	CC8CTR1-4896	48	96	1 ¼	6	1	160	9	\$3,178
---	---------------------	----	----	-----	---	---	-----	---	---------

- long grain veneer direction
- top is 1 ¼" thick
- laminate worksurface, no charge if standard laminate is selected
- glass worksurface with reverse bevel edge, (see page 74) call for quote
- aluminum edge available, specify and add \$2,483 list for CC8CTR1-4896

Rectangular Top 	CC8CTR1-4284	42	84	1 ¼	4	1	123	7	\$2,310
	CC8CTR1-3672	36	72	1 ¼	4	1	91	5	\$1,701

- long grain veneer direction
- top is 1 ¼" thick
- laminate worksurface, no charge if standard laminate is selected
- glass worksurface with reverse bevel edge, (see page 74) call for quote
- aluminum edge available, specify and add \$2,173 list for CC8CTR1-4284 and \$1,863 list for CC8CTR1-3672

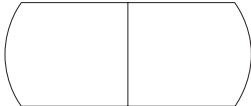
Description	① Model	W	L	H	Seat Capacity	Top Pieces	CTN WT	CU FT	List Price
Arc End Top 	CC8CTA1-60216	60	216	1 ¼	16	2	460	25	\$11,779
	CC8CTA1-60192	60	192	1 ¼	14	2	409	23	\$10,255
	CC8CTA1-60168	60	168	1 ¼	12	2	358	20	\$8,774
	CC8CTA1-60144	60	144	1 ¼	10	2	308	17	\$7,345

- short grain veneer direction
- top is 1 ¼" thick and in two sections
- laminate worksurface, no charge if standard laminate is selected
- glass worksurface with reverse bevel edge, (see page 74) call for quote

Arc End Top 	CC8CTA1-48216	48	216	1 ¼	16	2	370	21	\$9,039
	CC8CTA1-48192	48	192	1 ¼	14	2	330	18	\$7,881
	CC8CTA1-48168	48	168	1 ¼	12	2	289	16	\$6,755
	CC8CTA1-48144	48	144	1 ¼	8	2	248	14	\$5,662
	CC8CTA1-48120	48	120	1 ¼	6	2	207	11	\$4,597

- short grain veneer direction
- top is 1 ¼" thick and in two sections
- laminate worksurface, no charge if standard laminate is selected
- glass worksurface with reverse bevel edge, (see page 74) call for quote

Arc End Top 	CC8CTA1-4896	48	96	1 ¼	6	1	160	9	\$3,364
--	---------------------	----	----	-----	---	---	-----	---	---------

- long grain veneer direction
- top is 1 ¼" thick
- laminate worksurface, no charge if standard laminate is selected
- glass worksurface with reverse bevel edge, (see page 74) call for quote

Arc End Top 	CC8CTA1-4284	42	84	1 ¼	4	1	123	7	\$2,444
	CC8CTA1-3672	36	72	1 ¼	6	1	91	5	\$1,799

- long grain veneer direction
- top is 1 ¼" thick
- laminate worksurface, no charge if standard laminate is selected
- glass worksurface with reverse bevel edge, (see page 74) call for quote





To Order, Specify:

Rectangular Top

- ① Model Number
- ② Wood Species
- ③ Finish Color
- ④ Edge Detail
 - A. Straight
 - B. Aluminum Trim
- ⑤ Worksurface Option
 - A. Veneer
 - B. Laminate
 - C. White Back Painted Glass - Glossy
 - D. White Back Painted Glass - Frosted (see page 74)
- ⑥ Power and Data Options (see page 322)
- ⑦ Other Product Options

Arc Top

- ① Model Number
- ② Wood Species
- ③ Finish Color
- ④ Worksurface Option
 - A. Veneer
 - B. Laminate
 - C. White Back Painted Glass - Glossy
 - D. White Back Painted Glass - Frosted (see page 74)
- ⑤ Power and Data Options (see page 322)
- ⑥ Other Product Options

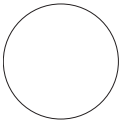
Description	① Model	W	L	H	Seat Capacity	Top Pieces	CTN WT	CU FT	List Price
Racetrack Top 	CC8CT01-60216	60	216	1 1/4	18	2	435	25	\$11,999
	CC8CT01-60192	60	192	1 1/4	16	2	384	23	\$10,444
	CC8CT01-60168	60	168	1 1/4	14	2	333	20	\$8,937
	CC8CT01-60144	60	144	1 1/4	10	2	283	17	\$7,481
	<ul style="list-style-type: none"> · short grain veneer direction · top is 1 1/4" thick and in two sections · laminate worksurface, no charge if standard laminate is selected · glass worksurface with reverse bevel edge, (see page 74) call for quote 								
Racetrack Top 	CC8CT01-48216	48	216	1 1/4	16	2	363	21	\$9,206
	CC8CT01-48192	48	192	1 1/4	14	2	314	18	\$8,027
	CC8CT01-48168	48	168	1 1/4	12	2	281	16	\$6,881
	CC8CT01-48144	48	144	1 1/4	8	2	232	14	\$5,765
	CC8CT01-48120	48	120	1 1/4	6	2	191	11	\$4,682
<ul style="list-style-type: none"> · short grain veneer direction · top is 1 1/4" thick and in two sections · laminate worksurface, no charge if standard laminate is selected · glass worksurface with reverse bevel edge, (see page 74) call for quote 									
Racetrack Top 	CC8CT01-4896	48	96	1 1/4	6	1	135	9	\$3,423
<ul style="list-style-type: none"> · long grain veneer direction · top is 1 1/4" thick · laminate worksurface, no charge if standard laminate is selected · glass worksurface with reverse bevel edge, (see page 74) call for quote 									
Racetrack Top 	CC8CT01-4284	42	84	1 1/4	4	1	110	7	\$2,488
	CC8CT01-3672	36	72	1 1/4	4	1	82	5	\$1,831
<ul style="list-style-type: none"> · long grain veneer direction · top is 1 1/4" thick · laminate worksurface, no charge if standard laminate is selected · glass worksurface with reverse bevel edge, (see page 74) call for quote 									
Round Top 	CC8CTD1-0048	48	48	1 1/4	4	1	81	5	\$3,182
	CC8CTD1-0042	42	42	1 1/4	4	1	62	4	\$2,925
<ul style="list-style-type: none"> · short grain veneer direction · top is 1 1/4" thick · laminate worksurface, no charge if standard laminate is selected · glass worksurface with reverse bevel edge, (see page 74) call for quote 									

COLLECTIVE CONFERENCE

Description	① Model	W	L	H	Seat Capacity	Top Pieces	CTN WT	CU FT	List Price
Boat Shape Top 	CC8CTB1-60216	38/60	216	1 ¼	18	2	460	25	\$11,155
	CC8CTB1-60192	38/60	192	1 ¼	16	2	409	23	\$9,791
	CC8CTB1-60168	36/60	168	1 ¼	14	2	358	20	\$8,389

- short grain veneer direction
- top is 1 ¼" thick and in two sections
- laminate worksurface, no charge if standard laminate is selected
- glass worksurface with reverse bevel edge, (see page 74) call for quote

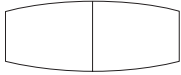
Boat Shape Top 	CC8CTB1-48144	36/48	144	1 ¼	8	2	248	14	\$7,039
	CC8CTB1-48120	36/48	120	1 ¼	6	2	207	11	\$5,722

- short grain veneer direction
- top is 1 ¼" thick and in two sections
- laminate worksurface, no charge if standard laminate is selected
- glass worksurface with reverse bevel edge, (see page 74) call for quote

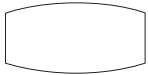
Boat Shape Top 	CC8CTB1-4896	34/48	96	1 ¼	6	1	160	9	\$4,203
--	---------------------	-------	----	-----	---	---	-----	---	---------

- long grain veneer direction
- top is 1 ¼" thick
- laminate worksurface, no charge if standard laminate is selected
- glass worksurface with reverse bevel edge, (see page 74) call for quote

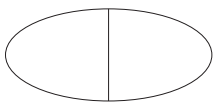
Ellipse Shape Top 	CC8CTE1-60144	60	144	1 ¼	10	2	238	17	\$9,986
	CC8CTE1-54120	54	120	1 ¼	8	2	181	13	\$6,416

- short grain veneer direction
- top is 1 ¼" thick and in two sections
- laminate worksurface, no charge if standard laminate is selected
- glass worksurface with reverse bevel edge, (see page 74) call for quote

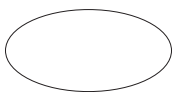
Ellipse Shape Top 	CC8CTE1-4896	48	96	1 ¼	6	2	123	9	\$4,733
---	---------------------	----	----	-----	---	---	-----	---	---------

- long grain veneer direction
- top is 1 ¼" thick
- laminate worksurface, no charge if standard laminate is selected
- glass worksurface with reverse bevel edge, (see page 74) call for quote

To Order, Specify:

- ① Model Number
- ② Wood Species
- ③ Finish Color
- ④ Worksurface Option
 - A. Veneer
 - B. Laminate
 - C. White Back Painted Glass - Glossy
 - D. White Back Painted Glass - Frosted (see page 74)
- ⑤ Power and Data Options (see page 322)
- ⑥ Other Product Options

Description	D	W	H	CTN WT	CU FT	① Model	List Price
Open Cable Base	3½	27	27⅞	67	3	CC8NCO1-0427	\$3,179
	3½	23	27⅞	57	57	CC8NCO1-0423	\$2,828

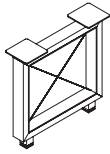

- X-shaped stainless steel cable accent
- wood surround
- Silver powder coated inner metal frame
- telescopic feet are anodized aluminum

Closed Cable Base	5	27	27⅞	77	4	CC8NCC1-0527	\$3,765
	5	23	27⅞	67	3	CC8NCC1-0523	\$3,509

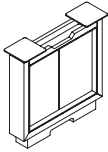
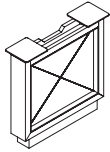

side 1

side 2

- X-shaped stainless steel cable accent
- wood surround
- Silver powder coated inner metal frame
- wood panel one side; hinged doors with 3" opening on top for wire management and touch latch

Closed Cable Middle Base	5	27	15¾	86	4	CC8NCM1-0527	\$2,796
--------------------------	---	----	-----	----	---	--------------	---------

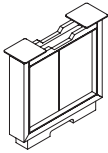
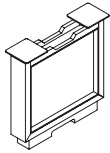

side 1

side 2

- wood surround
- Silver powder coated inner metal frame
- wood panel one side; hinged doors with 3" opening on top for wire management and touch latch
- plinth base with cut-out in bottom 2" x 6"

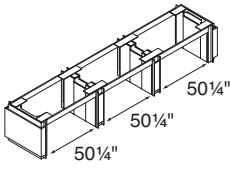
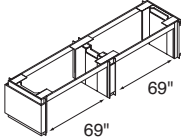
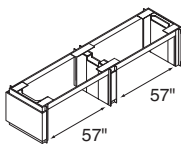
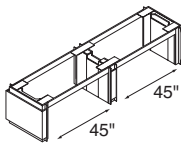
Description	D	W	H	CTN WT	CU FT	① Model	List Price
32" Panel Base with Apron Rails and Center Bases 	32 1/4	174	27 3/4	398	20	CC8NPC2-32174	\$11,940
<ul style="list-style-type: none"> use with 216" x 60" table top anodized aluminum trim hinged doors one side with touch latch; outside bases have 3" opening on top of hinged door side for wire management; middle bases have 3" opening on top both sides for wire management adjustable glides arc or flat panel front - add \$464 for arc end panel front, arc only on outside panels 							
32" Panel Base with Apron Rails and Center Base 	32 1/4	156	27 3/4	301	15	CC8NPC2-32156	\$8,106
<ul style="list-style-type: none"> use with 192" x 60" table top anodized aluminum trim hinged doors one side with touch latch; outside bases have 3" opening on top of hinged door side for wire management; middle bases have 3" opening on top both sides for wire management adjustable glides arc or flat panel front - add \$464 for arc end panel front, arc only on outside panels 							
32" Panel Base with Apron Rails and Center Base 	32 1/4	132	27 3/4	298	15	CC8NPC2-32132	\$7,867
<ul style="list-style-type: none"> use with 168" x 60" table top anodized aluminum trim hinged doors one side with touch latch; outside bases have 3" opening on top of hinged door side for wire management; middle bases have 3" opening on top both sides for wire management adjustable glides arc or flat panel front - add \$464 for arc end panel front, arc only on outside panels 							
32" Panel Base with Apron Rails and Center Base 	32 1/4	108	27 3/4	295	15	CC8NPC2-32108	\$7,501
<ul style="list-style-type: none"> use with 144" x 60" table top anodized aluminum trim hinged doors one side with touch latch; outside bases have 3" opening on top of hinged door side for wire management; middle bases have 3" opening on top both sides for wire management adjustable glides arc or flat panel front - add \$464 for arc end panel front, arc only on outside panels 							

To Order, Specify:

Open Cable Base

- ① Model Number
- ② Wood Species
- ③ Finish Color
- ④ Other Product Options

Closed Cable Base

- ① Model Number
- ② Wood Species
- ③ Finish Scheme
 - A. Outer Frame & Plinth - Veneer only
 - B. Inner Panel/Door - Veneer or Paint (see page 77)
- ④ Other Product Options

Panel Base with Apron Rails and Center Bases

- ① Model Number
- ② Wood Species
- ③ Base Front Panel
 - A. Arc
 - B. Flat (see page 76)
- ④ Finish Scheme
 - A. Outer Frame & Plinth - Veneer only
 - B. Inner Panel/Door - Veneer or Paint (see page 78)
- ④ Other Product Options

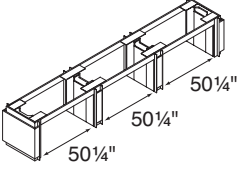
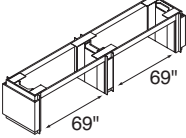
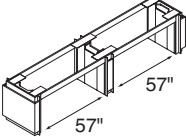
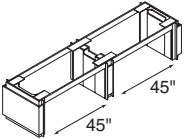
Description	D	W	H	CTN WT	CU FT	Model	List Price
27" Panel Base with Apron Rails and Center Bases 	27 1/4	174	27 3/4	365	16	CC8NPC2-27174	\$7,408
<ul style="list-style-type: none"> · use with 216" x 48" table top · anodized aluminum trim · hinged doors one side with touch latch; outside bases have 3" opening on top of hinged door side for wire management; middle bases have 3" opening on top both sides for wire management · adjustable glides · arc or flat panel front - add \$464 for arc end panel front, arc only on outside panels 							
27" Panel Base with Apron Rails and Center Base 	27 1/4	156	27 3/4	279	12	CC8NPC2-27156	\$7,475
<ul style="list-style-type: none"> · use with 192" x 48" table top · anodized aluminum trim · hinged doors one side with touch latch; outside bases have 3" opening on top of hinged door side for wire management; middle base has 3" opening on top both sides for wire management · adjustable glides · arc or flat panel front - add \$464 for arc end panel front, arc only on outside panels 							
27" Panel Base with Apron Rails and Center Base 	27 1/4	132	27 3/4	276	12	CC8NPC2-27132	\$7,186
<ul style="list-style-type: none"> · use with 168" x 48" table top · anodized aluminum trim · hinged doors one side with touch latch; outside bases have 3" opening on top of hinged door side for wire management; middle base has 3" opening on top both sides for wire management · adjustable glides · arc or flat panel front - add \$464 for arc end panel front, arc only on outside panels 							
27" Panel Base with Apron Rails and Center Base 	27 1/4	108	27 3/4	274	12	CC8NPC2-27108	\$7,074
<ul style="list-style-type: none"> · use with 144" x 48" table top · anodized aluminum trim · hinged doors one side with touch latch; outside bases have 3" opening on top of hinged door side for wire management; middle base has 3" opening on top both sides for wire management · adjustable glides · arc or flat panel front - add \$464 for arc end panel front, arc only on outside panels 							

COLLECTIVE CONFERENCE

Description	D	W	H	CTN WT	CU FT	① Model	List Price
27" Panel Base with Apron Rails	27 ¼	84	27 ¾	187	8	CC8NPC2-2784	\$3,762

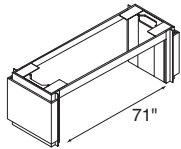

- use with 120" x 48" table top
- anodized aluminum trim
- hinged doors one side with touch latch; 3" opening on top of hinged door side for wire management
- adjustable glides
- arc or flat panel front - add \$464 for arc end panel front, arc only on outside panels

27" Panel Base with Apron Rails	27 ¼	60	27 ¾	184	8	CC8NPC2-2760	\$3,648
---------------------------------	------	----	------	-----	---	--------------	---------

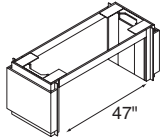

- use with 96" x 48" table top
- anodized aluminum trim
- hinged doors one side with touch latch; 3" opening on top of hinged door side for wire management
- adjustable glides
- arc or flat panel front - add \$464 for arc end panel front, arc only on outside panels

To Order, Specify:

- ① Model Number
- ② Wood Species
- ③ Base Front Panel
 - A. Arc
 - B. Flat
(see page 76)
- ④ Finish Scheme
 - A. Outer Frame & Plinth - veneer only
 - B. Inner Panel/Door - Veneer or Paint
(see page 78)
- ④ Other Product Options

Description	D	W	H	CTN WT	CU FT	Model	List Price
-------------	---	---	---	-----------	----------	-------	------------

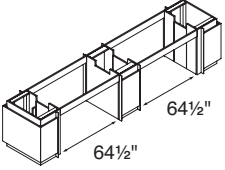
27" Rectangular Base with Apron Rails and Center Base 	27 1/4	174	27 3/4	354	15	CC8NRC2-27174	\$10,511
--	--------	-----	--------	-----	----	----------------------	-----------------

- use with 216" x 60" table top
- anodized aluminum trim
- hinged doors one side with touch latch; outside bases have 3" opening on top of hinged door side for wire management; middle base has 3" opening on top both sides for wire management
- adjustable glides

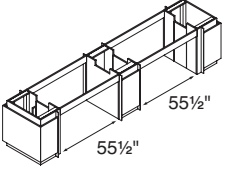
27" Rectangular Base with Apron Rails and Center Base 	27 1/4	156	27 3/4	352	15	CC8NRC2-27156	\$8,025
--	--------	-----	--------	-----	----	----------------------	----------------

- use with 192" x 60" table top
- anodized aluminum trim
- hinged doors one side with touch latch; outside bases have 3" opening on top of hinged door side for wire management; middle base has 3" opening on top both sides for wire management
- adjustable glides

27" Rectangular Base with Apron Rails and Center Base 	27 1/4	132	27 3/4	350	15	CC8NRC2-27132	\$7,912
---	--------	-----	--------	-----	----	----------------------	----------------

- use with 168" x 60" table top
- anodized aluminum trim
- hinged doors one side with touch latch; outside bases have 3" opening on top of hinged door side for wire management; middle base has 3" opening on top both sides for wire management
- adjustable glides

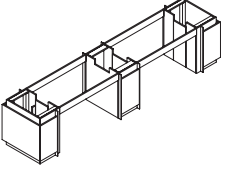
27" Rectangular Base with Apron Rails and Center Base 	27 1/4	108	27 3/4	347	15	CC8NRC2-27108	\$7,800
--	--------	-----	--------	-----	----	----------------------	----------------

- use with 144" x 60" table top
- anodized aluminum trim
- hinged doors one side with touch latch; outside bases have 3" opening on top of hinged door side for wire management; middle base has 3" opening on top both sides for wire management
- adjustable glides

COLLECTIVE CONFERENCE

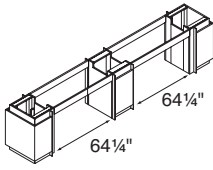
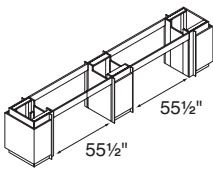
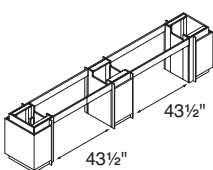
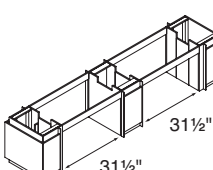
Description	D	W	H	CTN WT	CU FT	1 Model	List Price
<p>21" Rectangular Base with Apron Rails and Center Base</p> 	21 1/4	174	27 3/4	308	15	CC8NRC2-21174	\$9,328
<ul style="list-style-type: none"> use with 216" x 48" table top anodized aluminum trim hinged doors one side with touch latch; outside bases have 3" opening on top of hinged door side for wire management; middle base has 3" opening on top both sides for wire management adjustable glides 							
<p>21" Rectangular Base with Apron Rails and Center Base</p> 	21 1/4	156	27 3/4	306	15	CC8NRC2-21156	\$7,136
<ul style="list-style-type: none"> use with 192" x 48" table top anodized aluminum trim hinged doors one side with touch latch; outside bases have 3" opening on top of hinged door side for wire management; middle base has 3" opening on top both sides for wire management adjustable glides 							
<p>21" Rectangular Base with Apron Rails and Center Base</p> 	21 1/4	132	27 3/4	304	15	CC8NRC2-21132	\$7,039
<ul style="list-style-type: none"> use with 168" x 48" table top anodized aluminum trim hinged doors one side with touch latch; outside bases have 3" opening on top of hinged door side for wire management; middle base has 3" opening on top both sides for wire management adjustable glides 							
<p>21" Rectangular Base with Apron Rails and Center Base</p> 	21 1/4	108	27 3/4	302	15	CC8NRC2-21108	\$6,915
<ul style="list-style-type: none"> use with 144" x 48" table top anodized aluminum trim hinged doors one side with touch latch; outside bases have 3" opening on top of hinged door side for wire management; middle base has 3" opening on top both sides for wire management adjustable glides 							

To Order, Specify:

- 1 Model Number
- 2 Wood Species
- 3 Finish Scheme
 - A. Outer Frame & Plinth - veneer only
 - B. Inner Panel/Door - veneer or paint (see page 78)
- 4 Other Product Options

Description	D	W	H	CTN WT	CU FT	① Model	List Price
21" Rectangular Base with Apron Rails	21 ¼	84	27 ¾	212	10	CC8NRC2-2184	\$4,721

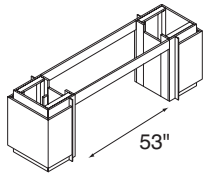

- use with 120" x 48" table top
- anodized aluminum trim
- hinged doors one side with touch latch; 3" opening on top of hinged door side for wire management
- adjustable glides

21" Rectangular Base with Apron Rails	21 ¼	60	27 ¾	208	10	CC8NRC2-2160	\$4,607
---------------------------------------	------	----	------	-----	----	--------------	---------

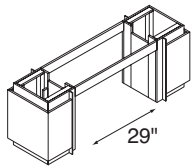

- use with 96" x 48" table top
- anodized aluminum trim
- hinged doors one side with touch latch; 3" opening on top of hinged door side for wire management
- adjustable glides

Description	D	W	H	CTN WT	CU FT	① Model	List Price
26" Dia. Base	26	26	27 ¾	93	13	CC8NCD1-0026	\$2,621

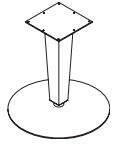

• 26" dia. disk base is Silver powder coated aluminum with veneer column

Cylinder Base	24	24	27 ¾	89	11	CC8NCY9-0024	\$2,655
---------------	----	----	------	----	----	--------------	---------

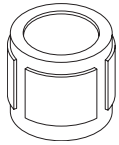

• 24" dia. base has 4 accent panels

To Order, Specify:

21" Rectangular Base with Apron Rails

- ① Model Number
- ② Wood Species
- ③ Finish Scheme
 - A. Outer Frame & Plinth - veneer only
 - B. Inner Panel/Door - Veneer or Paint
(see page 78)
- ④ Other Product Options

26" Dia. Base

- ① Model Number
- ② Wood Species
- ③ Finish Color
- ④ Other Product Options

Cylinder Base

- ① Model Number
- ② Wood Species
- ③ Finish Scheme
 - A. Chassis Frame - veneer only
 - B. Accent Panel - Veneer or Paint
(see page 77)
- ④ Other Product Options

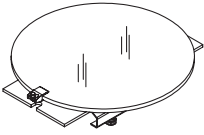
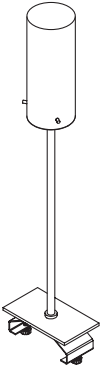
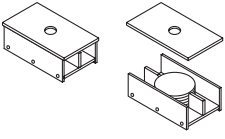
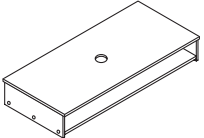
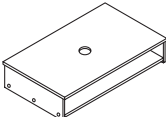
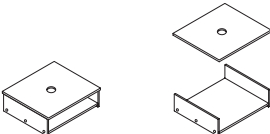
Description	D	W	H	CTN WT	CU FT	① Model	List Price
Accessory Shelf  <ul style="list-style-type: none"> · 15" dia. glass shelf; not designed to rotate · anodized aluminum 	15	16		13	2	CC9CNA1-1516	\$1,649
Lamp  <ul style="list-style-type: none"> · anodized aluminum 	6 ¾	4	30	10	1	CC9CNL1-0704	\$1,118
Coaster  <ul style="list-style-type: none"> · includes (5) anodized aluminum coasters; finger lift lid 	6 ¾	4		6	1	CC9CNC1-0704	\$1,201
Storage  <ul style="list-style-type: none"> · storage - use for pens, notepads, and etc. · anodized aluminum 	6 ¾	16	1 ¾	7	1	CC9CNS1-0716	\$740
Storage  <ul style="list-style-type: none"> · storage - use for pens, notepads, and etc. · anodized aluminum 	6 ¾	12	1 ¾	7	1	CC9CNS1-0712	\$656
Storage  <ul style="list-style-type: none"> · storage - use for pens, notepads, and etc. · anodized aluminum 	6 ¾	8	1 ¾	6	1	CC9CNS1-0708	\$580

COLLECTIVE CONFERENCE

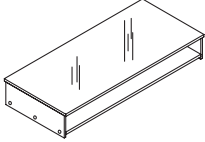
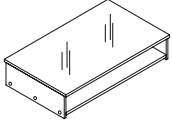
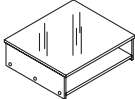
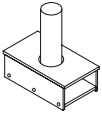
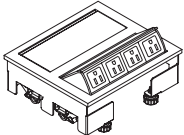
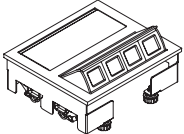
Description	D	W	H	CTN WT	CU FT	① Model	List Price
Glass Panel  <ul style="list-style-type: none"> · glass surface; not for use as storage · anodized aluminum 	6¾	16	1¾	7	1	CC9CNG1-0716	\$633
Glass Panel  <ul style="list-style-type: none"> · glass surface; not for use as storage · anodized aluminum 	6¾	12	1¾	6	1	CC9CNG1-0712	\$593
Glass Panel  <ul style="list-style-type: none"> · glass surface; not for use as storage · anodized aluminum 	6¾	8	1¾	6	1	CC9CNG1-0708	\$570
Vase  <ul style="list-style-type: none"> · 7" vase (6" visible); clear glass · anodized aluminum 	6¾	4		5	1	CC9CNV1-0704	\$637
Power Data Module  electrical side  voice/data side <ul style="list-style-type: none"> · anodized aluminum; one touch accessibility; (4) electrical one side; (4) voice/data ports opposite side; voice/data adapter kit; voice/data jacks & couples sold separately; 10 ft., 15 amp cord with plug; UL listed · accepts up to four type 3 telecom jacks (see page 330 and 331) ▲ · NOTE: Use for consoles only 	7⅞	8		6	1	CC9CNE1-0708	\$1,157

To Order, Specify:

① Model Number

Collective Presentation Product Information



COLLECTIVE PRESENTATION

Collective Presentation Product Information

Exterior Wood Materials

Exterior surfaces are made from the finest selected veneers to achieve clarity and consistency in the Collective Presentation product line. To attain a pleasing, symmetrical pattern, all veneers in Collective Presentation are book-matched. All exterior solid lumber is matched to coordinate with the veneer.

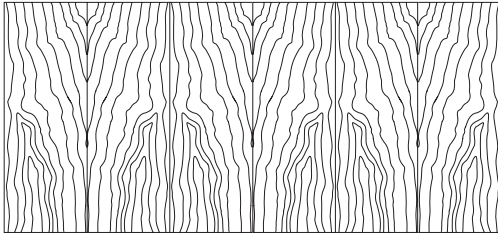

Book Matched Example

Alternating pieces of veneer are flipped over so they face each other like the pages within a book

Collective Presentation is available in flat cut cherry, maple, and walnut veneer.

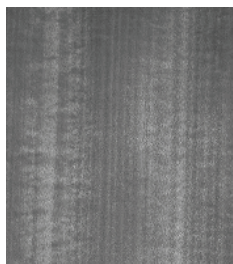

Makore veneer is also available on Collective Presentation at no upcharge. Makore is also known as African Cherry veneer. When makore veneer is quarter cut it has a nice straight grain pattern with a pinkish brown cast and is a good alternative for cherry veneer for Collective Presentation.



Anegre veneer is a premium veneer choice and is quarter cut to have a figure cut (fiddle back) pattern. There is a 15% upcharge applied to the list for Anegre veneer

A wide range of wood stains have been formulated to enhance the beauty of the veneer.

Solid painted finishes on MDF are also offered on drawer and door fronts to provide an accent to the Collective Presentation product.

Work Surface Construction

Tops are 3-ply balanced construction, 1½" thick with solid matching hardwood 1.5mm rims.

Matching or coordinating high pressure laminate in a veneer grain can be applied to the top surface and is available at no additional charge for some finishes.

Case Construction

Outside panels are 1¾" and joined together by mortise and tenon construction. In addition to mortise and tenon joint construction, pedestal joints are reinforced with screws, cleats, brackets and glue. Tops are secured to the chassis with top fastening cleats screwed to the inside of the panels.

Cabinet doors have 110° swing hinges to allow adequate access into the interior of the cabinet.

Leveling glides are provided in both plinth base or telescopic foot.

Extruded Aluminum Components

Telescopic Feet, Valance Rails, Tool Rails, and Spacers all are made from an alloy aluminum compound, made up of 10% post consumer scrap, 60% post industrial scrap and 30% primary aluminum. The aluminum meets or exceeds the guidelines of USGBC - LEED V2.2. The parts are precisely machined and then processed in a clear anodized finish for a natural aluminum appearance.

Fabricated or Casted Metal Components

The metal is laser cut, bended and robotically welded to the exact specifications, polished and powder coated to blend with the anodized aluminum.

Access Kneespace Panel

Wall stud construction style frame is made from 16-gauge steel, stamped and laser cut. Pop-rivets are used to combine frames and create various widths. Frames are coated with silver powder coat. The back is open and is designed to sit up against a wall, to allow for wiring access.

Aluminum Glass Doors

Aluminum glass doors and modesty panels have extruded aluminum frames with 4mm thick smudge resistant frosted glass or clear glass back painted in bright white.

Drawer Box Construction

The 9ply unidirectional hardwood sides of the drawer box are 7/16" thick assembled with English dovetail construction at each corner of the box. The drawer bottom panel is ¼" thick fitting into a groove machined into the side of the box. Interiors are sanded and coated with a clear U.V. finish to protect against shrinking, swelling or warping, and to provide a clean, smooth feel and appearance.

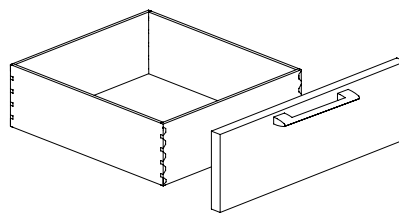

Drawer Suspension

The high quality black drawer suspensions carry a lifetime warranty. Slides feature steel ball bearings for longer life with cushioned in/out stops. File and box drawers have 100% full extension with over travel.

Collective Presentation Product Information

Locking

Credenzas feature door locking option to provide maximum security and flexibility.

Units are shipped randomly keyed as standard (units tagged in the grouping are keyed alike). Keyed alike units are available if requested at no upcharge. Removable cores for in-field re-keying are standard.

Finish - Stain/Colors

We offer a wide variety of wood stains and paint colors on the Collective Presentation. Please see the chart below. Samples are available upon request, through our website or by contacting Customer Service. Former finish names are listed in parentheses for reference.

CH1 Cherry *Flat Cut Veneer*

MK2 Makore *Quarter Cut Veneer*

AUT Autumn (<i>Autumn Cherry</i>)	EAR Earthy
BRL Barley	LGC Legacy (<i>Legacy Cherry</i>)
BBN Bourbon (<i>Natural Cherry</i>)	PRL Praline (<i>Vintage Cherry</i>)
BRG Brighton (<i>Brighton Cherry</i>)	SAF Saffron (<i>Medium Cherry</i>)
CLA Classic (<i>Classic Cherry</i>)	

MA1 Maple *Flat Cut Veneer*

ALE Ale (<i>Natural Maple</i>)	FLX Flax
BUT Butterscotch	VEN Venetian (<i>Dark Mahogany</i>)
CIN Cinnamon	

WA1 Walnut *Flat Cut Veneer*

AUB Auburn (<i>Windsor Mahogany</i>)	SIE Sienna
ESP Espresso	TOF Toffee
MCH Mocha	TRF Truffle
NTO Night Owl (<i>Vintage Walnut</i>)	

PNT Paint *MDF Board*

BKD Backdrop	GRV Greek Villa
BFX Black Fox	NET Network Gray
BWH Bright White	NWH Nonchalant White
CGP Cargo Pants	STM Storm
CHT Chatroom	TRC Tricorn Black
FRR French Roast	

AN5 Anegre* *Figured Quarter Cut*

CHM Champagne	TPZ Topaz
---------------	-----------

* Anegre is a premium veneer, a 15% upcharge to the list of each item will be applied

Protective Top Coat

DuraTex™ offers exceptional hardness along with abrasion and impact resistance, it has been formulated to eliminate hazardous and harmful gases that are normally associated with wood finish.

DuraTex™ Features

Safety - Significantly reduces hazardous formaldehyde emissions which help improve the quality of the of the indoor air we breathe.
 Quality - Developed to be tough and durable with special attention to appearance. The DuraTex™ finish preserves the natural beauty of wood.
 Durability - Designed to meet a wide range of demanding performance and environmental standards to withstand even the highest wear and tear.

Product Modification

Laminate Tops

Work surface only, no additional upcharge if Collective's coordinating wood grain laminate is specified. Contact Customer Service for any other laminate request.

Cherry Finishes	Maple Finishes	Walnut Finishes
<i>Autumn</i>	<i>Ale</i>	<i>Auburn</i>
<i>Barley</i>	<i>Cinnamon</i>	<i>Mocha</i>
<i>Brighton</i>	<i>Venetian</i>	<i>Night Owl</i>
<i>Classic</i>		<i>Sienna</i>
<i>Legacy</i>		<i>Toffee</i>
<i>Praline</i>		<i>Truffle</i>
<i>Saffron</i>		

Special Finishes

Special finishes can be requested by following the instruction in the general introduction section, page 3. There is a one time charge of \$289 list per order.

Oak Veneer

Upon request veneer can be changed from the standard offering to oak plain sliced veneer with a 40% upcharge onto the list of each item.

Collective Presentation Product Information

Edge Profile Hardware

Collective Presentation utilizes a clean cut straight edge profile with a 1.5mm veneer rim. The Elite hardware is made of anodized aluminum. Longer versions of pull are available for other applications

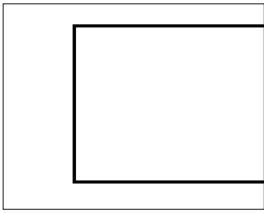

Straight Edge Profile

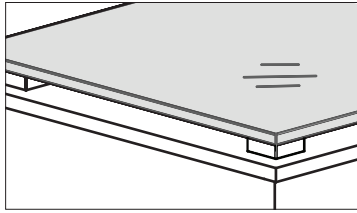

Floating Frosted Glass Top
with screen print on underside
(wood sub-top with aluminum spacers)

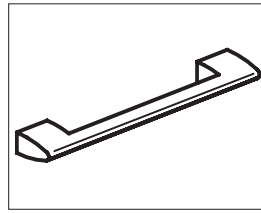

Elite Pull (PK)
Anodized Aluminum Finish

End Panel Grommet

Collective Presentation credenzas feature a brushed stainless steel 4" x 2" end panel grommet to allow for wire management. The end panel grommet is optional on other items; see pricing pages for more information.

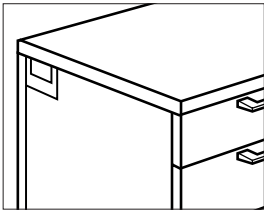

Grommet Location

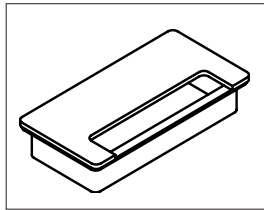

Grommet (G7C)
Brush Stainless Steel

Foot/Plinth Style Base

The Collective Presentation features an anodized aluminum foot. Plinth base feature is not available on presentation product, so adequate ventilation can be achieved for technology.

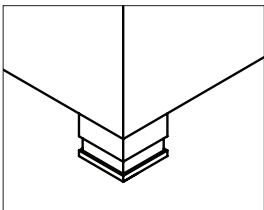

Foot Style
Anodized Aluminum Finish

Foot Leveling Details

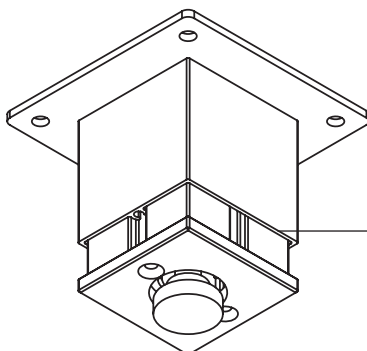

Telescopic cover can slide up to provide access for adjustment

Collective Presentation Product Information

Wall Options

Collective Presentation addresses today's information and presentation environments. Technology integration and collaborative solutions benefit reception areas, private offices, open plan spaces, conference or casual meeting rooms. Collective Presentation consists of two separate groupings: Media Walls and Interactive Walls. Due to different heights and width variations the two are not interchangeable. Walls require specification of left and right end panels or towers, and a center wall panel.

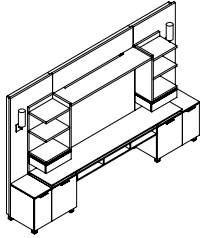

Media Wall

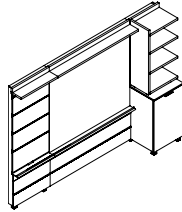

Interactive Wall

Media Wall

The Media Wall supports various technology applications including plasma display, laptop, receiver/DVD, projector, speakers and video conferencing. The Media Wall creates 86" and 71" heights and includes a center wall panel, technology niche storage with back panel, technology credenza, end towers, glass and wood tops. Panels and towers are always wall mounted.

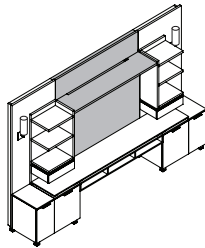

Center Wall Panel

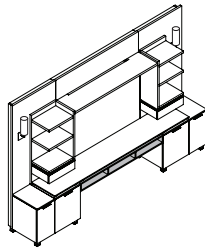

Technology Console

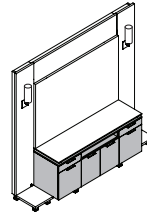

Technology Credenza

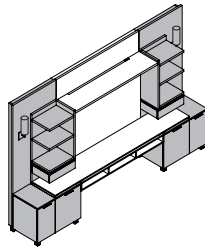

End Towers

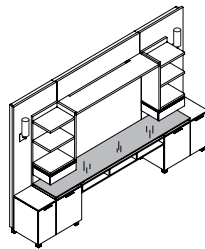
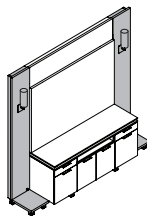

Glass and Wood Tops

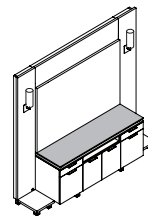

Interactive Wall

The Interactive Wall features marker board for meetings and presentations. Tackable panels are used for collateral materials and more. The Interactive Wall is available in 86" and 74" heights and has a center wall with marker board, tackable panel on one or both sides, or end tower on one or both sides. Interactive wall towers and center walls are always wall mounted.

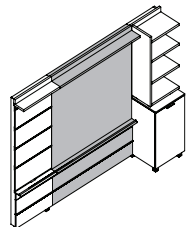

Center Wall with Marker Board

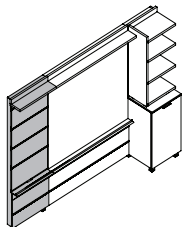

Tackable Panel

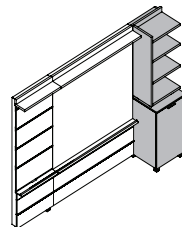

End Tower

Collective Presentation Product Information

Center Access Panel

The Media Wall below shows how wires feed down the center wall panel into the technology niche storage with access panel and out to the end towers.

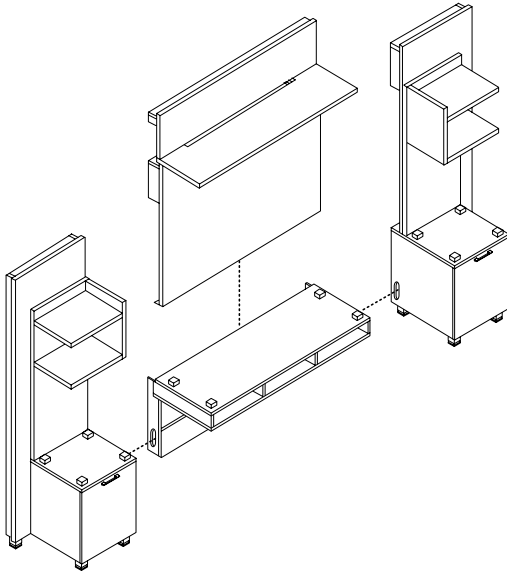

Media Wall with Technology Cubby
(Front View)

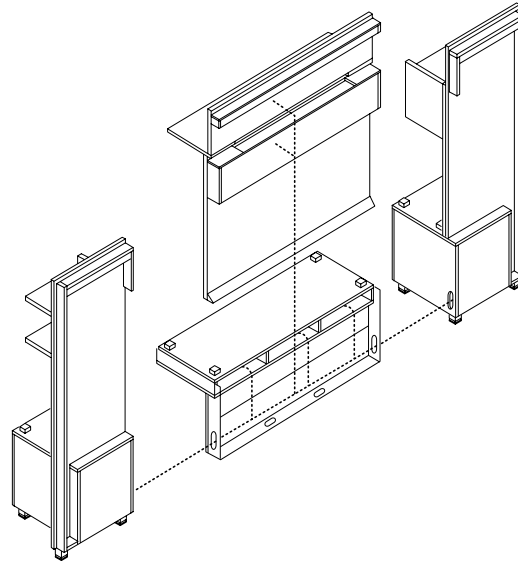

Media Wall with Technology Cubby
(Back View)

Center Technology Credenza

The diagram below shows the Media Wall with wire management routed down the center wall panel into the technology credenza and out to the end towers.

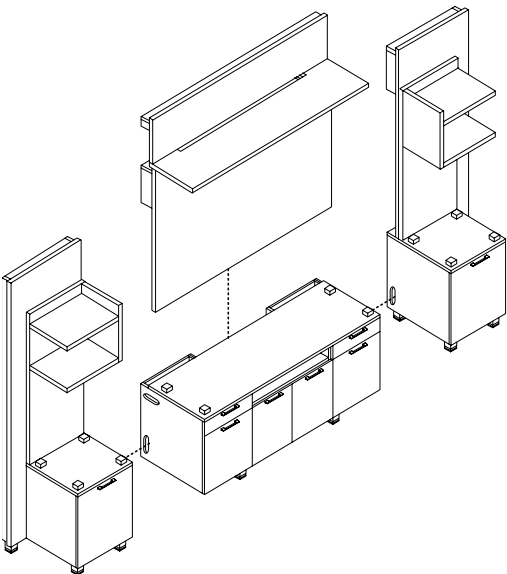

Media Wall with Technology Credenza
(Front View)

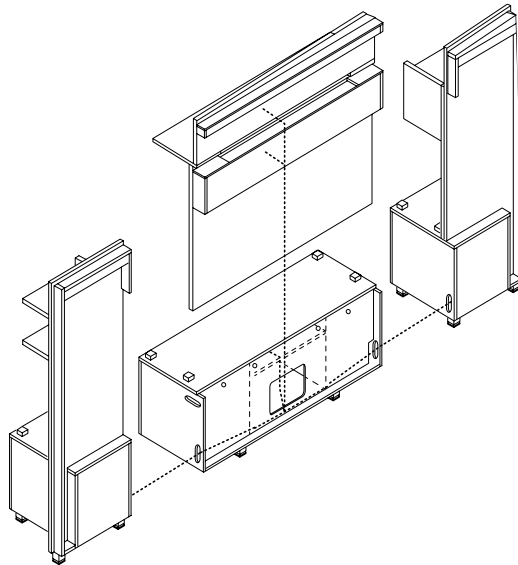

Media Wall with Technology Credenza
(Front View)

Collective Presentation Product Information

Access Panel Wiring

The access panel consist of two hinged panels with a lid stay mechanism on upper panel. The panel allows access to building power and communication and features concealed lay-in cable channel, and optional modular power distribution system.

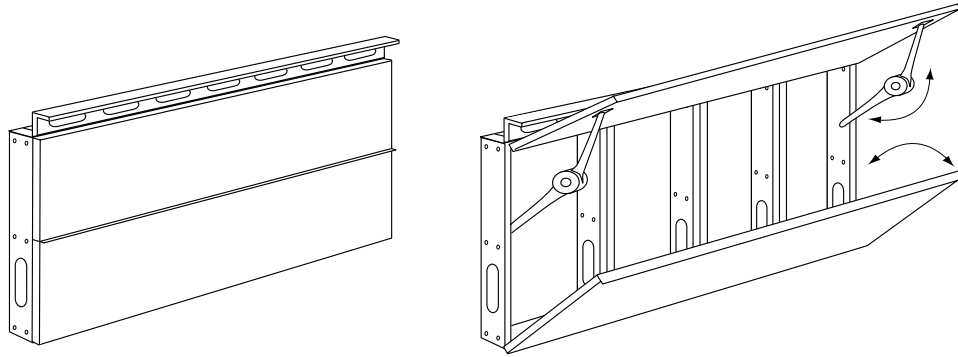

Installation of the Data Adapter Kit & Base Plate

1. Select the appropriate adapter.
2. Snap jack into adapter following the instructions provided with the jack.
3. Once assembled, snap adapter into the notched, square holes in the orientation shown.
4. If provided, snap adapter into any 1 $\frac{3}{8}$ " x 2 $\frac{3}{4}$ " opening.

Note: Verify fit of jack in adapter before ordering large quantities as manufacturer designs may change without notice.

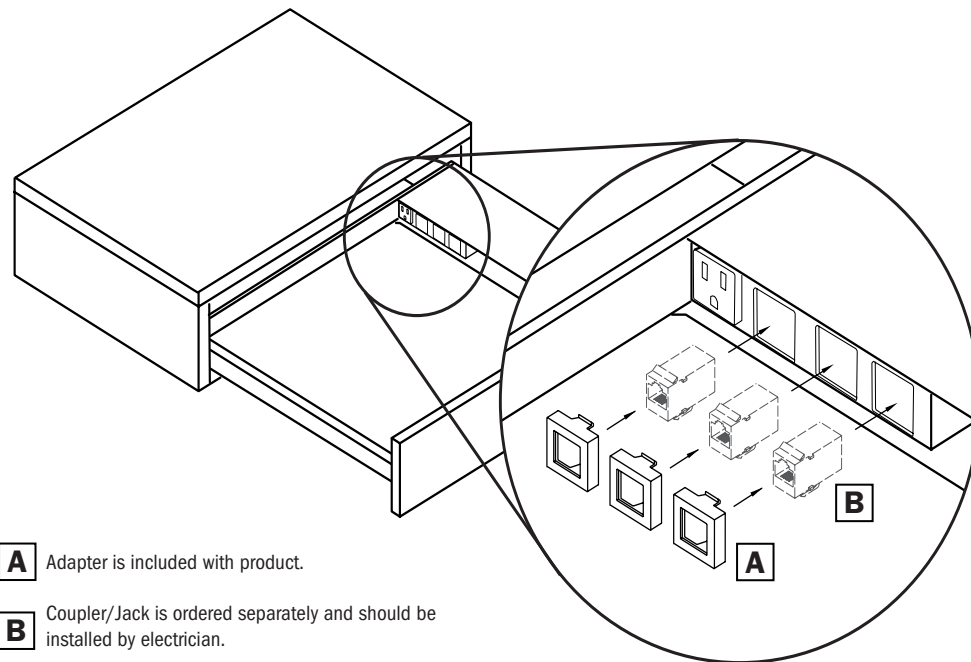

A Adapter is included with product.

B Coupler/Jack is ordered separately and should be installed by electrician.

Collective Presentation Product Information

Material Options and Finish Schemes

Collective Presentation uses a modern mix of materials: paint, veneer, and aluminum. Veneer choices are maple, cherry, makore and walnut. Anegre wood species requires an upcharge; see page 161. Eleven paint colors are available; see page 161. Wood worksurface tops or rims on laminate worksurface top, are available in veneer finishes only.

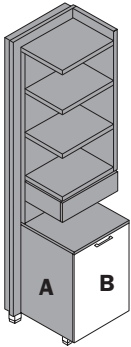

Interactive Wall End Tower

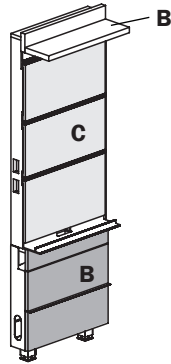

Interactive Wall End Display

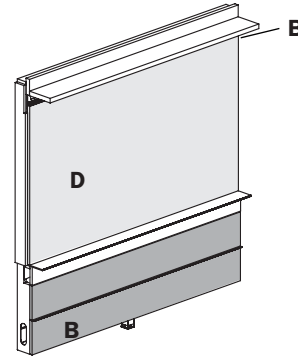

Interactive Wall Center

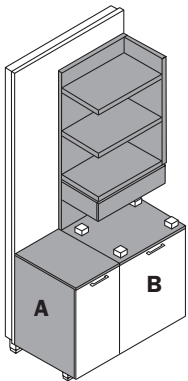

Media Wall End Tower

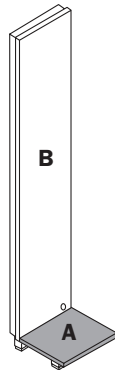

Media Wall Speaker Tower

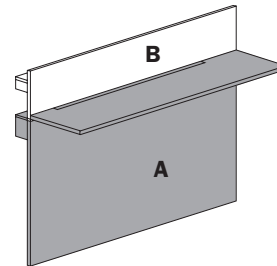

Media Wall Center Wall Panel

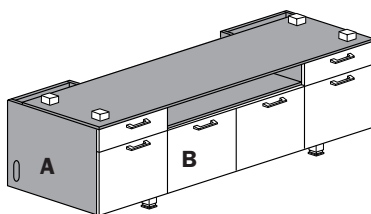

Media Wall Technology Credenza

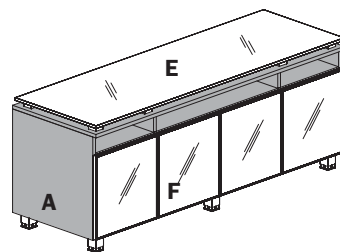

Freestanding Media Credenza

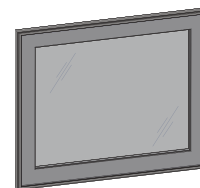

Aluminum Frame Door with[▲]
 Frosted Glass with Acid Etch Front
 Frosted Glass with Acid Etch Front (matte)
 Glossy Low Iron White Back Painted Glass (shiny)

(clear anodized aluminum frame)

Material Key

- A veneer finish only
- B veneer or paint
- C fabric tackable surface (aluminum tool rail between panels)
- D dry erase marker board (marker/eraser tray)
- E frosted glass top - screen print on underside
- F aluminum frame glass doors

Collective Presentation Product Information

Finish and Product Reference Codes

Select	Code	Select	Code	Select	Code
Veneer		Walnut Finishes		Laminate Coordinates	
Cherry Flat Cut	CH1	Auburn	AUB	Cherry Wood Grain Patterns	
Makore Quarter Cut	MK2	Espresso	ESP	Autumn	AUT
Maple Flat Cut	MA1	Mocha	MCH	Barley	BRL
Walnut Flat Cut	WA1	Night Owl	NTO	Bourbon	BBN
Anegre <i>(add 15% to list)</i>	AN5	Sienna	SIE	Brighton	BRG
		Toffee	TOF	Classic	CLA
		Truffle	TRF	Legacy	LGC
				Praline	PRL
Finish		Anegre Finishes		Saffron	SAF
Cherry/Makore Finishes		Champagne	CHM		
Autumn	AUT	Topaz	TPZ	Maple Wood Grain Patterns	
Barley	BRL			Ale	ALE
Bourbon	BBN	Paint Finishes		Cinnamon	CIN
Brighton	BRG	Backdrop	BKD	Venetian	VEN
Classic	CLA	Black Fox	BFX		
Earthy	EAR	Bright White	BWH	Walnut Wood Grain Patterns	
Legacy	LGC	Cargo Pants	CGP	Auburn	AUB
Praline	PRL	Chatroom	CHT	Mocha	MCH
Saffron	SAF	French Roast	FRR	Night Owl	NTO
		Greek Villa	GRV	Sienna	SIE
		Network Gray	NET	Toffee	TOF
		Nonchalant White	NWH	Truffle	TRF
		Storm	STM		
		Tricorn Black	TRC	Metal Finish	
				Arctic Silver	ASL
				Anodized Clear Aluminum	AAL

Order Check List:

Specify:

- 1. Model Number
- 2. Finish Scheme/Color (see page 166)
- 3. Wood Species - cherry - makore - maple - walnut - anegre (15% upcharge to list applies)
- 4. Top Options - standard veneer - laminate surface (see page 162)
- 5. Other Product Options
- 6. Power and Data Accessories (*drawing showing location and orientation must accompany order*)
- 7. Side Mark Information (*i.e. room number, East Conference Room*)
- 8. Shipping Address (*contact name and phone number*)
- 9. Special Delivery Instructions (*i.e. call before delivery, deliver to job site*)

Description	D	W	H	CTN WT	CU FT	① Model	List Price
86" h Storage Tower with Laptop Drawer	24	34 1/2	86 1/4	316	48	MDOQDTAR-2435	\$7,250
	24	34 1/2	86 1/4	316	48	MDOQDTAL-2435	\$7,250

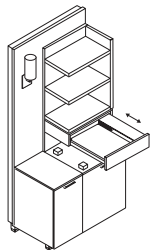

left shown with optional sconce

- use with 18 1/2" d top
- three open fixed shelves
- laptop drawer with power port
- three blanks (for future data use)
- two adaptor kits to fit coupler/jacks
- aluminum spacers included
- 20 1/2" w storage compartment with one adjustable shelf and cut-out for wall access
- 14" w storage compartment with a concealed storage drawer
- wire management cut-out in pedestal opposite door hinge
- telescopic feet
- locking doors available, specify and add \$210 list
- pull-out shelf in large compartment available, specify and add \$220 list
- wall sconce available, specify and add \$312 list

86" h Storage Tower with Drawer	24	34 1/2	86 1/4	304	48	MDOQDTBR-2435	\$6,635
	24	34 1/2	86 1/4	304	48	MDOQDTBL-2435	\$6,635

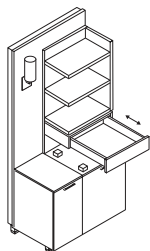

left shown with optional sconce

- use with 18 1/2" d top
- three open fixed shelves and drawer
- aluminum spacers included
- 20 1/2" w storage compartment with one adjustable shelf and cut-out for wall access
- 14" w storage compartment with a concealed storage drawer
- wire management cut-out in pedestal opposite door hinge
- telescopic feet
- locking doors available, specify and add \$210 list
- pull-out shelf in large compartment available, specify and add \$220 list
- wall sconce available, specify and add \$312 list

86" h Storage Tower	24	34 1/2	86 1/4	273	48	MDOQDT1R-2435	\$5,665
	24	34 1/2	86 1/4	273	48	MDOQDT1L-2435	\$5,665

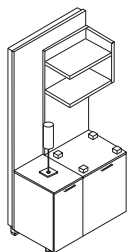

left shown with optional lamp

- use with 18 1/2" d top
- two open fixed shelves and drawer
- aluminum spacers included
- 20 1/2" w storage compartment with one adjustable shelf and cut-out for wall access
- 14" w storage compartment with a concealed storage drawer
- wire management cut-out in pedestal opposite door hinge
- telescopic feet
- locking doors available, specify and add \$210 list
- pull-out shelf in large compartment available, specify and add \$220 list
- credenza lamp available, specify and add \$346 list

COLLECTIVE PRESENTATION

Description	D	W	H	CTN WT	CU FT	① Model	List Price
86" h Wood Door Storage Tower	24	34 ½	86 ¼	247	48	MDOQTT1R-2435	\$6,335
	24	34 ½	86 ¼	247	48	MDOQTT1L-2435	\$6,335

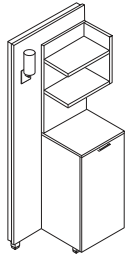

left shown with optional scance

- two open fixed shelves
- storage compartment with two adjustable shelves and cut-out for wall access
- wire management cut-out in pedestal opposite door hinge
- telescopic feet
- locking doors available, *specify and add \$105 list* ▲
- pull-out shelf in closed compartment available, *specify and add \$220 list*
- wall scance available, *specify and add \$312 list*

86" h Glass Door Storage Tower	24	34 ½	86 ¼	244	48	MDOQTGR-2435	\$6,170
	24	34 ½	86 ¼	244	48	MDOQTGL-2435	\$6,170

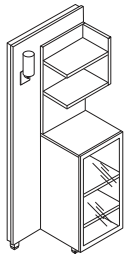

left shown with optional scance

- two open fixed shelves
- glass door is touch latch
- storage compartment with two adjustable shelves and cut-out for wall access
- telescopic feet
- locking not available
- pull-out shelf in closed compartment available, *specify and add \$220 list*
- wall scance available, *specify and add \$312 list*

To Order, Specify:

- ① Model Number
- ② Wood Species on Top/Chassis/Shelves -
Cherry (CH1), Makore (MK2), Maple (MA1),
Walnut (WA1) or Anegre Premium (AN5)
(see page 161)
- ③ Finish Color for Top/Chassis/Shelves (see page 166)
- ④ Finish Color for Back Panel and Door Fronts
A. Same as Top
B. Paint Color (see page 161)
- ⑤ Glass Door Option (see page 166) ▲

Description	D	W	H	CTN WT	CU FT	① Model	List Price
86" h Refreshment/Storage Tower	24	30	86 1/4	268	41	MDOQRT1R-2430	\$5,957
	24	30	86 1/4	268	41	MDOQRT1L-2430	\$5,957

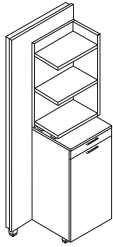

left shown

- three open fixed shelves
- aluminum spacers included
- storage drawer
- storage compartment with cut-out for ventilation or wall access
- wire management cut-out in pedestal opposite door hinge
- telescopic feet
- locking door available, specify and add \$105 list
- two adjustable shelves, specify and add \$280 list
- open interior space: 22 1/2" d x 22 1/2" w x 31" h

86" h Garage Tower	24	30	86 1/4	254	42	MDOQGT1R-2430	\$5,256
	24	30	86 1/4	254	42	MDOQGT1L-2430	\$5,256

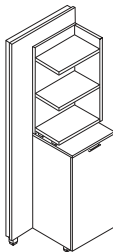

left shown

- three open fixed shelves
- aluminum spacers included
- stores mobile technology cart, see page 195 (order separately)
- wire management cut-out in pedestal opposite door hinge
- telescopic feet
- locking door available, specify and add \$105 list
- open bottom: 20 3/4" d x 17" w

Description	D	W	H	CTN WT	CU FT	① Model	List Price
86" h Storage Tower with Laptop Drawer	24	26 ½	86 ¼	239	37	MDOQSTAR-2427	\$5,711
	24	26 ½	86 ¼	239	37	MDOQSTAL-2427	\$5,711

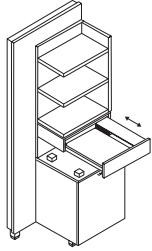

left shown

- use with 18 ½" d top
- three open fixed shelves
- laptop drawer with power port
- three blanks (for future data use)
- two adaptor kits to fit coupler/jacks
- aluminum spacers included
- 20 ½" w storage compartment with one adjustable shelf and cut-out for wall access
- wire management cut-out in pedestal opposite door hinge
- telescopic feet
- locking door available, specify and add \$105 list
- pull-out shelf in closed compartment available, specify and add \$312 list

86" h Storage Tower with Drawer	24	26 ½	86 ¼	239	37	MDOQSTBR-2427	\$5,096
	24	26 ½	86 ¼	239	37	MDOQSTBL-2427	\$5,096

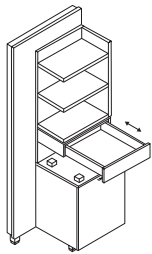

left shown

- use with 18 ½" d top
- three open fixed shelves and drawer
- aluminum spacers included
- 20 ½" w storage compartment with one adjustable shelf and cut-out for wall access
- wire management cut-out in pedestal opposite door hinge
- telescopic feet
- locking door available, specify and add \$105 list
- pull-out shelf in closed compartment available, specify and add \$312 list

To Order, Specify:

- ① Model Number
- ② Wood Species on Top/Chassis/Shelves -
Cherry (CH1), Makore (MK2), Maple (MA1),
Walnut (WA1) or Anegre Premium (AN5)
(see page 161)
- ③ Finish Color for Top/Chassis/Shelves (see page 161)
- ④ Finish Color for Back Panel and Door Fronts
A. Same as Top
B. Paint Color (see page 161)

Description	D	W	H	CTN WT	CU FT	① Model	List Price
86" h Storage Tower	24	26 1/2	86 1/4	197	37	MDOQST1R-2427	\$4,351
	24	26 1/2	86 1/4	197	37	MDOQST1L-2427	\$4,351

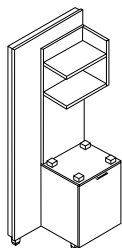

left shown

- use with 18 1/2" d top
- two open fixed shelves
- aluminum spacers included
- 20 1/2" w storage compartment with one adjustable shelf and cut-out for wall access
- wire management cut-out in pedestal opposite door hinge
- telescopic feet
- locking door available, specify and add \$105 list
- pull-out shelf in closed compartment available, specify and add \$220 list
- credenza lamp available, specify and add \$329 list

86" h Storage Tower	24	27	86 1/4	163	38	MDOQSTZR-2427	\$4,292
	24	27	86 1/4	163	38	MDOQSTZL-2427	\$4,292

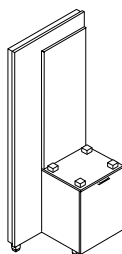

left shown

- use with 18 1/2" d top
- aluminum spacers included
- 20 1/2" w storage compartment with one adjustable shelf and cut-out for wall access
- wire management cut-out in pedestal opposite door hinge
- telescopic feet
- locking door available, specify and add \$105 list
- pull-out shelf in closed compartment available, specify and add \$220 list
- credenza lamp available, specify and add \$346 list

86" h Glass Door Storage Tower	24	20 1/2	86 1/4	214	30	MDOQNT1R-2421	\$4,935
	24	20 1/2	86 1/4	214	30	MDOQNT1L-2421	\$4,935

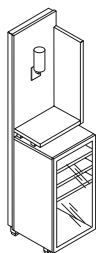

left shown with optional sconce

- one open fixed shelf
- aluminum spacers included
- glass door is touch latch
- storage compartment with two adjustable shelves and cut out for wall access
- wire management cut-out in pedestal opposite door hinge
- telescopic feet
- locking not available
- pull-out shelf in closed compartment available, specify and add \$220 list
- wall sconce available, specify and add \$312 list

86" h Speaker Tower	24	14	86 1/4	63	21	MDOQHT1R-2414	\$2,726
	24	14	86 1/4	63	21	MDOQHT1L-2414	\$2,726

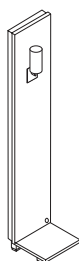

left shown with optional sconce

- 1 1/4" d grommet installed on attaching side of back panel
- position on media wall determines left or right
- telescopic feet
- wall sconce available, specify and add \$312 list

COLLECTIVE PRESENTATION

Description	D	W	H	CTN WT	CU FT	① Model	List Price
71" h Storage Tower with Laptop Drawer	24	34 ½	71 ¼	276	43	MDOQDSAR-2435	\$5,984
	24	34 ½	71 ¼	276	43	MDOQDSAL-2435	\$5,984

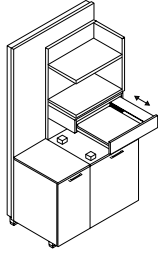

left shown

- use with 18 ½" d top
- two open fixed shelves
- laptop drawer with power port
- three blanks (for future data use)
- two adaptor kits to fit coupler/jacks
- aluminum spacers included
- 20 ½" w storage compartment with one adjustable shelf and cut-out for wall access
- 14" w storage compartment with a concealed storage drawer
- one power port
- wire management cut-out in pedestal opposite door hinge
- telescopic feet
- locking doors available, specify and add \$210 list
- pull-out shelf in large compartment available, specify and add \$220 list

71" h Storage Tower with Drawer	24	34 ½	71 ¼	264	43	MDOQDSBR-2435	\$5,370
	24	34 ½	71 ¼	264	43	MDOQDSBL-2435	\$5,370

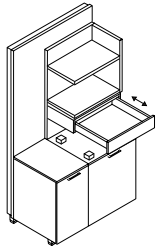

left shown

- use with 18 ½" d top
- two open fixed shelves and drawer
- aluminum spacers included
- 20 ½" w storage compartment with one adjustable shelf and cut-out for wall access
- 14" w storage compartment with a concealed storage drawer
- telescopic feet
- locking doors available, specify and add \$210 list
- pull-out shelf in large compartment available, specify and add \$220 list

71" h Storage Tower	24	34 ½	71 ¼	233	43	MDOQDS1R-2435	\$5,157
	24	34 ½	71 ¼	233	43	MDOQDS1L-2435	\$5,157

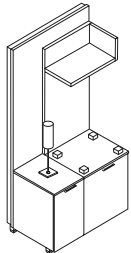

left shown

- use with 18 ½" d top
- one open fixed shelf
- aluminum spacers included
- 20 ½" w storage compartment with one adjustable shelf and cut-out for wall access
- 14" w storage compartment with a concealed storage drawer
- wire management cut-out in pedestal opposite door hinge
- telescopic feet
- locking doors available, specify and add \$210 list
- pull-out shelf in large compartment available, specify and add \$220 list
- credenza lamp available, specify and add \$346 list

To Order, Specify:

- ① Model Number
- ② Wood Species on Top/Chassis/Shelves - Cherry (CH1), Makore (MK2), Maple (MA1), Walnut (WA1) or Anegre Premium (AN5) (see page 161)
- ③ Finish Color for Top/Chassis/Shelves (see page 161)
- ④ Finish Color for Back Panel and Door Fronts
 - A. Same as Top
 - B. Paint Color (see page 161)
- ⑤ Glass Door Option (see page 166)

Description	D	W	H	CTN WT	CU FT	① Model	List Price
71" h Storage Tower with Laptop Drawer	24	26½	71¼	203	33	MDOQSSAR-2427	\$5,599
	24	26½	71¼	203	33	MDOQSSAL-2427	\$5,599

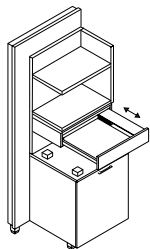

left shown

- use with 18½" d top
- two open fixed shelves
- laptop drawer with one power port
- three blanks (for future data use)
- two adaptor kits to fit coupler/jacks
- aluminum spacers included
- 20½" w storage compartment with one adjustable shelf and cut-out for wall access
- wire management cut-out in pedestal opposite door hinge
- telescopic feet
- locking doors available, specify and add \$210 list
- pull-out shelf in large compartment available, specify and add \$220 list

71" h Storage Tower with Drawer	24	26½	71¼	203	33	MDOQSSBR-2427	\$4,985
	24	26½	71¼	203	33	MDOQSSBL-2427	\$4,985

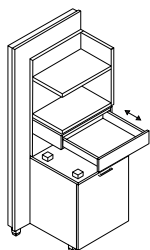

left shown

- use with 18½" d top
- two open fixed shelves and drawer
- aluminum spacers included
- 20½" w storage compartment with one adjustable shelf and cut-out for wall access
- wire management cut-out in pedestal opposite door hinge
- telescopic feet
- locking doors available, specify and add \$105 list
- pull-out shelf in large compartment available, specify and add \$220 list

71" h Storage Tower	24	26½	71¼	161	33	MDOQSS1R-2427	\$3,443
	24	26½	71¼	161	33	MDOQSS1L-2427	\$3,443

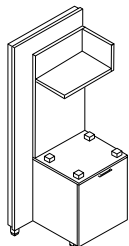

left shown

- use with 18½" d top
- one open fixed shelf
- aluminum spacers included
- 20½" w storage compartment with one adjustable shelf and cut-out for wall access
- wire management cut-out in pedestal opposite door hinge
- telescopic feet
- locking doors available, specify and add \$105 list
- pull-out shelf in large compartment available, specify and add \$220 list
- credenza lamp available, specify and add \$346 list

COLLECTIVE PRESENTATION

Description	D	W	H	CTN WT	CU FT	① Model	List Price
71" h Storage Tower	24	27	71 ¼	148	33	MDOQSSZR-2427	\$2,951
	24	27	71 ¼	148	33	MDOQSSZL-2427	\$2,951

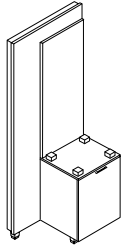

left shown

- use with 18 ½" d top
- aluminum spacers included
- 20 ½" w storage compartment with one adjustable shelf and cut-out for wall access
- wire management cut-out in pedestal opposite door hinge
- telescopic feet
- locking door available, specify and add \$105 list
- pull-out shelf in closed compartment available, specify and add \$220 list
- credenza lamp available, specify and add \$346 list

71" h Speaker Tower	19 ¾	14	71 ¼	55	14	MDOQHS1R-2414	\$2,340
	19 ¾	14	71 ¼	55	14	MDOQHS1L-2414	\$2,340



left shown with optional sconce

- 1 ¼" grommet installed on attaching side of back panel
- position on media wall determines left or right
- telescopic feet
- wall sconce available, specify and add \$312 list

To Order, Specify:

- ① Model Number
- ② Wood Species on Top/Chassis/Shelves -
Cherry (CH1), Makore (MK2), Maple (MA1),
Walnut (WA1) or Anegre Premium (AN5)
(see page 161)
- ③ Finish Color for Top/Chassis/Shelves (see page 161)
- ④ Finish Color for Back Panel and Door Front
A. Same as Top
B. Paint Color (see page 161)

Description	D	W	H	CTN WT	CU FT	① Model	List Price
Technology Credenza	24	72	26½	238	32	MDOTCRD-2472	\$5,519
	24	66	26½	234	29	MDOTCRD-2466	\$5,340

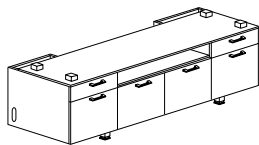

- unhanded
- not freestanding
- order top separately, see next page
- 2 pencil/hinge pedestals with adjustable shelves each end, 18" w
- 2 hinge/door pedestals center, 18" w
- technology cubby, 36" w
- wire management cut-outs in back panel
- aluminum spacers included
- telescopic feet
- locking drawers not available
- locking doors available, specify and add \$315 list
- pull-out shelf (on outside hinged doors) available, specify and add \$220 list each

Technology Credenza	24	54	26½	194	24	MDOTCRD-2454	\$4,837
---------------------	----	----	-----	-----	----	--------------	---------

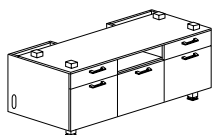

- unhanded
- not freestanding
- order top separately, see next page
- 2 pencil/hinge pedestals with adjustable shelves each end, 18" w
- 1 hinge/door pedestal center, 18" w
- technology cubby, 18" w
- wire management cut-outs in back panel
- aluminum spacers included
- telescopic feet
- locking drawers not available
- locking doors available, specify and add \$315 list
- pull-out shelf (on outside hinged doors) available, specify and add \$220 list each

Technology Credenza	24	72	26½	225	32	MDOTCRO-2472	\$4,483
	24	66	26½	210	29	MDOTCRO-2466	\$4,379

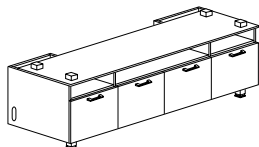

- unhanded
- not freestanding
- order top separately, see next page
- 4 hinge door pedestals, 18" w
- outer hinge door pedestals with adjustable shelves
- 2 technology cubbies, 18" w
- 1 technology cubby, 36" w
- wire management cut-outs in back panel
- aluminum spacers included
- telescopic feet
- locking doors available, specify and add \$315 list
- pull-out shelf (on outside hinged doors) available, specify and add \$220 list each

Technology Credenza	24	54	26½	182	24	MDOTCRO-2454	\$3,608
---------------------	----	----	-----	-----	----	--------------	---------

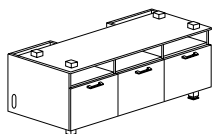

- unhanded
- not freestanding
- order top separately, see next page
- 3 hinge door pedestals, 18" w
- outer hinge door pedestals with adjustable shelves
- 3 technology niches, 18" w
- wire management cut-outs in back panel
- mount to end units for support
- aluminum spacers included
- telescopic feet
- locking doors available, specify and add \$315 list
- pull-out shelf (on outside hinged doors) available, specify and add \$220 list each

COLLECTIVE PRESENTATION

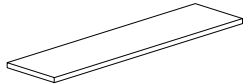
Description	D	W	H	CTN WT	CU FT	① Model	List Price
Wood Tops 	18½	113	1¼	68	4	MD7WTU1-19113	\$2,081
	18½	107	1¼	65	4	MD7WTU1-19107	\$1,993
	18½	101	1¼	61	4	MD7WTU1-19101	\$1,882
	18½	95	1¼	57	4	MD7WTU1-1995	\$1,770
	18½	72	1¼	43	3	MD7WTU1-1972	\$956
	18½	66	1¼	40	3	MD7WTU1-1966	\$919
	18½	60	1¼	36	2	MD7WTU1-1960	\$836
	18½	54	1¼	33	2	MD7WTU1-1954	\$700
	18½	20½	1¼	12	1	MD7WTU1-1921	\$410

• long grain veneer direction

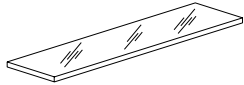
Glass Tops 	18½	113	¾	102	4	MD7WTUG-19113	\$3,050
	18½	107	¾	96	3	MD7WTUG-19107	\$2,956
	18½	101	¾	91	3	MD7WTUG-19101	\$2,793
	18½	95	¾	85	3	MD7WTUG-1995	\$2,628
	18½	72	¾	65	2	MD7WTUG-1972	\$1,522
	18½	66	¾	59	2	MD7WTUG-1966	\$1,465
	18½	60	¾	54	2	MD7WTUG-1960	\$1,332
	18½	54	¾	49	2	MD7WTUG-1954	\$1,201
	18½	20½	¾	18	1	MD7WTUG-1921	\$654

- frosted glass top - screen print on underside ▲
- eased edges
- fingerprint resisting coating on underside

To Order, Specify:

Credenzas

- ① Model Number
- ② Wood Species on Top/Chassis/Cubby- Cherry (CH1), Makore (MK2), Maple (MA1), Walnut (WA1) or Anegre Premium (AN5) (see page 161)
- ③ Finish Color for Top/Chassis (see page 161)
- ④ Finish Color for Door/Drawer Fronts
 - A. Same as Top
 - B. Paint Color (see page 161)

Wood Tops

- ① Model Number
- ② Wood Species - Cherry (CH1), Makore (MK2), Maple (MA1), Walnut (WA1) or Anegre Premium (AN5) (see page 161)
- ③ Finish Color (see page 161)

Description	D	W	H	CTN WT	CU FT	① Model	List Price
Technology Cubby Storage with Access Panel	21 ¾	72	26 ½	125	17	MD0TNS1-2272	\$3,281
	21 ¾	66	26 ½	115	15	MD0TNS1-2266	\$3,075
	21 ¾	60	26 ½	106	14	MD0TNS1-2260	\$2,823
	21 ¾	54	26 ½	96	13	MD0TNS1-2254	\$2,539

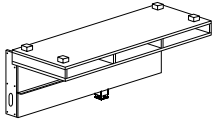

- unhanded
- not freestanding
- mount to end units for support
- use below credenza top
- panels open top up and bottom down for wire access

Center Wall Panel with Technology Shelf	19 ½	72	59 ¾	212	28	MD0TPT1-2072	\$3,171
	19 ½	66	59 ¾	195	26	MD0TPT1-2066	\$2,908
	19 ½	60	59 ¾	144	24	MD0TPT1-2060	\$2,683
	19 ½	54	59 ¾	162	21	MD0TPT1-2054	\$2,465

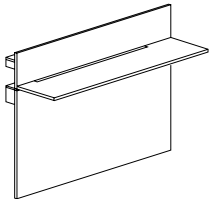

- use with 86" h ends
- unhanded
- 42" x 1 ¼" wire management opening (center shelf)

Center Wall Panel	5 ½	72	59 ½	184	20	MD0TPTZ-2072	\$2,751
	5 ½	66	59 ½	168	18	MD0TPTZ-2066	\$2,630
	5 ½	60	59 ½	153	17	MD0TPTZ-2060	\$2,431
	5 ½	54	59 ½	140	17	MD0TPTZ-2054	\$2,300

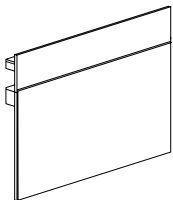

- use with 86" h ends
- unhanded

Center Wall Panel	5 ½	72	44 ¾	146	15	MD0TPS1-0672	\$1,730
	5 ½	66	44 ¾	135	14	MD0TPS1-0666	\$1,588
	5 ½	60	44 ¾	129	13	MD0TPS1-0660	\$1,465
	5 ½	54	44 ¾	111	11	MD0TPS1-0654	\$1,355

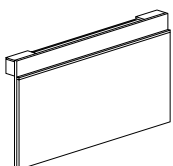

- use with 71" h ends
- unhanded

Description	D	W	H	CTN WT	CU FT	① Model	List Price
Serving Height Credenza	24	72	36 1/8	411	47	MD2BCR1-2472	\$6,752

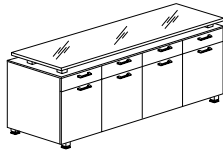

- freestanding
- frosted glass top - screen print on underside ▲
- 4 pencil/hinge pedestal with adjustable shelves, 18" w
- aluminum spacers included
- telescopic feet
- locking drawers not available
- locking doors available, specify and add \$315 list
- wood top, deduct \$326 list - species and finish will match chassis

To Order, Specify:

Access Panel

- ① Model Number
- ② Wood Species on Top/Chassis- Cherry (CH1), Makore (MK2), Maple (MA1), Walnut (WA1) or Anegre Premium (AN5) (see page 161)

Center Wall Panels

- ① Model Number
- ② Wood Species on Lower Panel/Shelf - Cherry (CH1), Makore (MK2), Maple (MA1), Walnut (WA1) or Anegre Premium (AN5), (see page 161)
- ③ Finish Color for Lower Panel/Shelf (see page 161)
- ④ Finish Color for Upper Center Panel
 - A. Same as Lower Panel/Shelf
 - B. Paint Color (see page 161)

Credenzas

- ① Model Number
- ② Wood Species on Chassis- Cherry (CH1), Makore (MK2), Maple (MA1), Walnut (WA1) or Anegre Premium (AN5) (see page 161)
- ③ Finish Color for Chassis (see page 161)
- ④ Finish Color for Door/Drawer Fronts
 - A. Same as Chassis
 - B. Paint Color (see page 161)

Description	D	W	H	CTN WT	CU FT	① Model	List Price
72" w Technology Credenza	24	72	29	357	39	MD0FCRG-2472	\$5,893

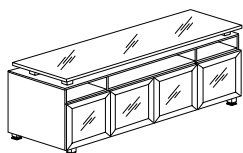

- freestanding
- frosted glass top - screen print on underside ▲
- 4 glass hinge door pedestals, 18" w
- outer hinge door pedestals with adjustable shelves
- 2 technology cubbies, 18" w
- 1 technology cubby, 36" w
- wire management cut-outs in back panel
- aluminum spacers included
- locking not available
- wood top, deduct \$326 list - species and finish will match chassis

72" w Technology Credenza	24	72	29	374	39	MD0FCRD-2472	\$5,434
---------------------------	----	----	----	-----	----	--------------	---------

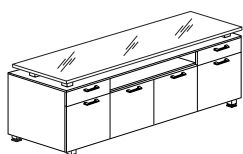

- freestanding
- frosted glass top - screen print on underside ▲
- 2 pencil/hinge door pedestals with adjustable shelves each end, 18" w
- 2 hinge door pedestals center, 18" w
- technology cubby 36" w
- wire management cut-outs in back panel
- aluminum spacers included
- telescopic feet
- locking drawers not available
- locking doors available, specify and add \$315 list
- wood top, deduct \$326 list - species and finish will match chassis

60" w Technology Credenza	24	60	29	302	33	MD0FCRE-2460	\$4,907
---------------------------	----	----	----	-----	----	--------------	---------



- freestanding
- frosted glass top - screen print on underside ▲
- 2 pencil/hinge door pedestals with adjustable shelves each end, 18" w
- open center, 24" w
- technology cubby 24" w
- wire management cut-outs in back panel
- adjustable shelf per compartment
- aluminum spacers included
- telescopic feet
- locking drawers not available
- locking doors available, specify and add \$210 list
- wood top, deduct \$326 list - species and finish will match chassis

Description	D	W	H	CTN WT	CU FT	① Model	List Price
90"w Technology Console	24	90	24 ¾	348	42	MDOFCSD-2490	\$6,077

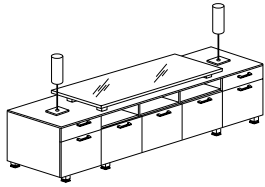

- freestanding
- frosted glass top - screen print on underside ▲
- 2 pencil/hinge door pedestals with adjustable shelves each end, 18"w
- 3 hinge door pedestals center, 18"w
- 3 technology cubbies center, 18"w
- wire management cut-outs in back panel
- aluminum spacers included
- two credenza lamps
- telescopic feet
- locking drawers not available
- locking doors available, specify and add \$525 list
- wood top, deduct \$245 list - species and finish will match chassis

72"w Asymmetric Technology Console	24	72	24 ¾	251	34	MDOACSDR-2472	\$5,681
	24	72	24 ¾	251	34	MDOACSDL-2472	\$5,681

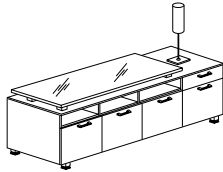

right shown

- freestanding
- frosted glass top - screen print on underside ▲
- 1 pencil/hinge door pedestal with adjustable shelf, 18"w
- 3 hinge door pedestals center, 18"w
- 3 technology cubbies, 18"w
- wire management cut-outs in back panel
- aluminum spacers included
- credenza lamp
- telescopic feet
- locking drawer not available
- locking doors available, specify and add \$315 list
- wood top, deduct \$245 list - species and finish will match chassis

To Order, Specify:

- ① Model Number
- ② Wood Species on Chassis- Cherry (CH1), Makore (MK2), Maple (MA1), Walnut (WA1) or Anegre Premium (AN5) (see page 161)
- ③ Finish Color for Chassis (see page 161)
- ④ Finish Color for Door/Drawer Fronts
 - A. Same as Chassis
 - B. Paint Color (see page 161)
- ⑤ Glass Door Option (see page 166)

▲ Revised 11/20/15

Description	D	W	H	CTN WT	CU FT	① Model	List Price
-------------	---	---	---	-----------	----------	---------	------------

72" w Technology Console

24	72	24 ¾	270	34	MD0FCSD-2472	\$5,250
----	----	------	-----	----	---------------------	----------------

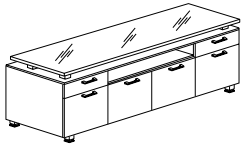

- freestanding
- frosted glass top - screen print on underside ▲
- 2 pencil/hinge door pedestals with adjustable shelves, 18" w
- 2 hinge door pedestals center, 18" w
- 1 technology cubby, 18" w
- wire management cut-outs in back panel
- aluminum spacers included
- telescopic feet
- locking drawers not available
- locking doors available, specify and add \$315 list
- wood top, deduct \$326 list - species and finish will match chassis

54" w Technology Console

24	54	24 ¾	216	26	MD0FCSOR-2454	\$4,749
24	54	24 ¾	216	26	MD0FCSOL-2454	\$4,749

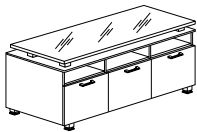

left shown

- freestanding
- frosted glass top - screen print on underside ▲
- 3 hinge door pedestals, 18" w
- 3 technology cubbies 18" w
- wire management cut-outs in back panel
- aluminum spacers included
- telescopic feet
- locking doors available, specify and add \$315 list
- wood top, deduct \$245 list - species and finish will match chassis

Low Platform

24	24	26 ½	53	11	MD0SOL1R-2424	\$1,619
24	24	26 ½	53	11	MD0SOL1L-2424	\$1,619

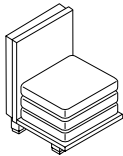

shown with optional cushions

- freestanding
- telescopic feet
- attachment determines left or right
- cushions available, see next page

Description	D	W	H	CTN WT	CU FT	① Model	List Price
Low Technology Console	24	72	26 ½	175	27	MD0FCLO-2472	\$4,115

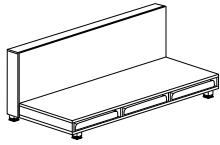

shown with optional cushions

- freestanding
- 3 technology cubbies
- wire management cut-outs
- telescopic feet
- cushions available, see below

Low Technology Console	24	66	26 ½	162	25	MD0FCLO-2466	\$3,741
	24	60	26 ½	148	22	MD0FCLO-2460	\$3,140

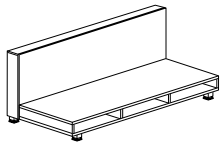

- freestanding
- 3 technology cubbies
- wire management cut-outs
- telescopic feet
- cushions available (will fit two cushions with a space in between), see below

Description	D	W	H	CTN WT	CU FT	① Model	List Price Per Grade
Cushion for Low Console	19 ¼	21 ¾	4	12	2	COL2424CUSH	COM \$290
							A \$301
							B \$320
							COL/C \$354
							D \$398
							E \$443
							F \$511
							G \$584
							H \$662
							I \$785
							J \$931
							L1 \$638
							L2 \$726

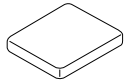

- com ydg: 1
- col sq ft: 18

To Order, Specify:

Low Console

- ① Model Number
- ② Wood Species on Chassis- Cherry (CH1), Makore (MK2), Maple (MA1), Walnut (WA1) or Anegre Premium (AN5) (see page 161)
- ③ Finish Color for Chassis (see page 161)
- ④ Finish Color for Door/Drawer Fronts
 - A. Same as Chassis
 - B. Paint Color (see page 161)

Low Platform and Low Technology Console

- ① Model Number
- ② Wood Species on Top - Cherry (CH1), Makore (MK2), Maple (MA1), Walnut (WA1), or Anegre Premium (AN5) (see page 161)
- ③ Finish Color for Top (see page 161)
- ④ Finish Color for Back Panel
 - A. Same as Top
 - B. Paint Color (see page 161)

Cushion

- ① Model Number
- ② Fabric - vendor, pattern, color

Description	D	W	H	CTN WT	CU FT	① Model	List Price
Asymmetric Hinged Door Storage	24	34 ½	29	172	19	MD0AHD1R-2435	\$2,148
	24	34 ½	29	172	19	MD0AHD1L-2435	\$2,148

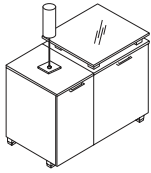

left shown with optional lamp

- freestanding
- frosted glass top - screen print on underside ▲
- credenza lamp
- lamp end determines left or right
- wire management cut-out in pedestal opposite door hinge
- telescopic feet
- locking doors available, specify and add \$210 list
- wood top, deduct \$191 - species and finish will match chassis

34 ½" w Hinged Door Storage	24	34 ½	29	179	19	MD0FHD1R-2435	\$1,897
	24	34 ½	29	179	19	MD0FHD1L-2435	\$1,897

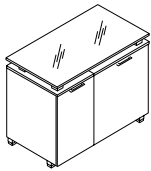

left shown

- freestanding
- frosted glass top - screen print on underside ▲
- wire management cut-out in pedestal opposite door hinge
- telescopic feet
- locking doors available, specify and add \$210 list
- wood top, deduct \$218 - species and finish will match chassis

20 ½" w Hinged Door Storage	24	20 ½	29	130	12	MD0FHD1R-2420	\$1,487
	24	20 ½	29	130	12	MD0FHD1L-2420	\$1,487

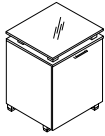

- freestanding
- frosted glass top - screen print on underside ▲
- wire management cut-out in pedestal opposite door hinge
- hinge determines left or right
- telescopic feet
- locking door available, specify and add \$105 list
- wood top, deduct \$191 - species and finish will match chassis

Wall Mount Storage Shelves	8	72	1 ¼	20	1	MD0WSS1-0872	\$1,045
	8	66	1 ¼	19	1	MD0WSS1-0866	\$971
	8	60	1 ¼	17	1	MD0WSS1-0860	\$870
	8	54	1 ¼	16	1	MD0WSS1-0854	\$730

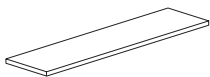

- mounting hardware included

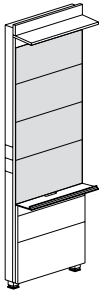
Description	D	W	H	CTN WT	CU FT	① Model	List Price Per Grade
86" h End Display Unit 	10 ¼	36	86 ¼	110	25	IT0EFT1R-1036	COM \$3,493
	10 ¼	36	86 ¼	110	25	IT0EFT1L-1036	A \$3,523 B \$3,581 C \$3,684 D \$3,816 E \$3,947 F \$4,153 G \$4,373 H \$4,608 I \$4,974 J \$5,414
						<ul style="list-style-type: none"> · use for 86" h interactive wall · wall mounted · upper panels: fabric · lower panels: veneer · anodized aluminum tray is 5 ⅜" d · lower panels open top up, bottom down for wire access · left or right determined by the placement on the wall · com ydg: 3 	

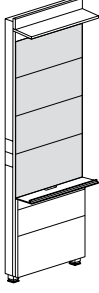
86" h End Display Unit 	10 ¼	30	86 ¼	94	21	IT0EFT1R-1030	COM \$2,842
	10 ¼	30	86 ¼	94	21	IT0EFT1L-1030	A \$2,872 B \$2,930 C \$3,033 D \$3,165 E \$3,296 F \$3,502 G \$3,722 H \$3,957 I \$4,323 J \$4,763
						<ul style="list-style-type: none"> · use for 86" h interactive wall · wall mounted · upper panels: fabric · lower panels: veneer · anodized aluminum tray is 5 ⅜" d · lower panels open top up, bottom down for wire access · left or right determined by the placement on the wall · com ydg: 3 	

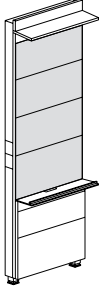
86" h End Display Unit 	10 ¼	24	86 ¼	76	21	IT0EFT1R-1024	COM \$2,202
	10 ¼	24	86 ¼	76	21	IT0EFT1L-1024	A \$2,228 B \$2,276 C \$2,362 D \$2,472 E \$2,581 F \$2,753 G \$2,936 H \$3,132 I \$3,437 J \$3,804
						<ul style="list-style-type: none"> · use for 86" h interactive wall · wall mounted · upper panels: fabric · lower panels: veneer · anodized aluminum tray is 5 ⅜" d · lower panels open top up, bottom down for wire access · left or right determined by the placement on the wall · com ydg: 2 ½ 	

To Order, Specify:

Storage Units

- ① Model Number
- ② Wood Species on Top/Chassis- Cherry (CH1), Makore (MK2), Maple (MA1), Walnut (WA1) or Anegre Premium (AN5) (see page 161)
- ③ Finish Color for Top/Chassis (see page 161)
- ④ Finish Color for Door Fronts
 - A. Same as Top
 - B. Paint Color (see page 161)

End Display Unit

- ① Model Number
- ② Wood Species - Cherry (CH1), Makore (MK2), Maple (MA1), Walnut (WA1) or Anegre Premium (AN5) (see page 161)
- ③ Finish Color (see page 161)
- ④ Fabric - vendor, pattern, color

Description	D	W	H	CTN WT	CU FT	① Model	List Price
86"h End Trim Panel	¼	3 ¼	74 ¼	3	1	IT0ETT1-0103	\$354

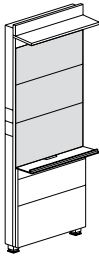

- used to cap end display unit
- must use for 86"h interactive wall
- order with end panel

Description	D	W	H	CTN WT	CU FT	① Model	List Price Per Grade
74" h End Display Unit 	10 ¼	36	74 ½	100	22	ITOEFS1R-1036	COM \$2,870
	10 ¼	36	74 ½	100	22	ITOEFS1L-1036	A \$2,901 B \$2,958 C \$3,061 D \$3,194 E \$3,325 F \$3,531 G \$3,750 H \$3,985 I \$4,352 J \$4,792
<ul style="list-style-type: none"> · use for 74" h interactive wall · wall mounted · upper panels: fabric · lower panels: veneer · anodized aluminum tray is 5 ⅜" d · lower panels open top up, bottom down for wire access · left or right determined by the placement on the wall 							

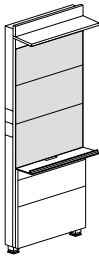
74" h End Display Unit 	10 ¼	30	74 ½	84	18	ITOEFS1R-1030	COM \$2,323
	10 ¼	30	74 ½	84	18	ITOEFS1L-1030	A \$2,354 B \$2,411 C \$2,514 D \$2,646 E \$2,778 F \$2,984 G \$3,203 H \$3,438 I \$3,805 J \$4,245
<ul style="list-style-type: none"> · use for 74" h interactive wall · wall mounted · upper panels: fabric · lower panels: veneer · anodized aluminum tray is 5 ⅜" d · lower panels open top up, bottom down for wire access · left or right determined by the placement on the wall 							

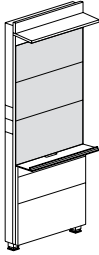
74" h End Display Unit 	10 ¼	24	74 ½	66	15	ITOEFS1R-1024	COM \$1,787
	10 ¼	24	74 ½	66	15	ITOEFS1L-1024	A \$1,812 B \$1,860 C \$1,946 D \$2,056 E \$2,166 F \$2,337 G \$2,520 H \$2,716 I \$3,021 J \$3,388
<ul style="list-style-type: none"> · use for 74" h interactive wall · wall mounted · upper panels: fabric · lower panels: veneer · anodized aluminum tray is 5 ⅜" d · lower panels open top up, bottom down for wire access · left or right determined by the placement on the wall 							

To Order, Specify:

End Trim Panel

- ① Model Number
- ② Wood Species on Top/Chassis- Cherry (CH1), Makore (MK2), Maple (MA1), Walnut (WA1) or Anegre Premium (AN5) (see page 161)

End Display Unit

- ① Model Number
- ② Wood Species - Cherry (CH1), Makore (MK2), Maple (MA1), Walnut (WA1) or Anegre Premium (AN5) (see page 161)
- ③ Finish Color (see page 161)
- ④ Fabric - vendor, pattern, color

Description	D	W	H	CTN WT	CU FT	① Model	List Price
74"h End Trim Panel	¼	3 ¼	74 ¼	3	1	IT0ETS1-0103	\$315



- used to cap end display unit
- must use for 74"h interactive wall
- order with end panel

Description	D	W	H	CTN WT	CU FT	① Model	List Price
86 ¼" h Center Wall Panel	11 ¼	72	86 ¼	185	44	ITOMPT1-1172	\$5,163
	11 ¼	66	86 ¼	172	41	ITOMPT1-1166	\$4,679
	11 ¼	60	86 ¼	156	38	ITOMPT1-1160	\$4,370
	11 ¼	54	86 ¼	141	34	ITOMPT1-1154	\$3,812
	11 ¼	48	86 ¼	132	30	ITOMPT1-1148	\$3,380

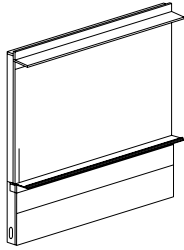

- use for 86" h interactive wall
- wall mounted
- dry erase - marker board 2" d x 53 ¼" w
- anodized aluminum tray is 5 ¾" d
- lower panels open top up, bottom down for wire access

Description	D	W	H	CTN WT	CU FT	① Model	List Price
74 ¼" h Center Wall Panel	11 ¼	72	74 ¼	172	37	ITOMPS1-1172	\$4,756
	11 ¼	66	74 ¼	159	35	ITOMPS1-1166	\$4,305
	11 ¼	60	74 ¼	146	31	ITOMPS1-1160	\$3,910
	11 ¼	54	74 ¼	130	29	ITOMPS1-1154	\$3,507
	11 ¼	48	74 ¼	116	25	ITOMPS1-1148	\$3,110

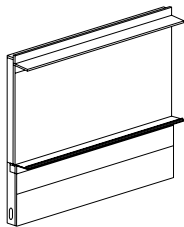

- use for 74" h interactive wall
- wall mounted
- dry erase - marker board 2" d x 41 ¼" w
- anodized aluminum tray is 5 ¾" d
- lower panels open top up, bottom down for wire access

To Order, Specify:

End Trim Panel

- ① Model Number
- ② Wood Species on Top/Chassis- Cherry (CH1), Makore (MK2), Maple (MA1), Walnut (WA1) or Anegre Premium (AN5) (see page 161)

Center Wall Panel

- ① Model Number
- ② Wood Species - Cherry (CH1), Makore (MK2), Maple (MA1), Walnut (WA1) or Anegre Premium (AN5) (see page 161)
- ③ Finish Color (see page 161)

Description	D	W	H	CTN WT	CU FT	① Model	List Price
86" h Storage Tower with Laptop Drawer	24	34 1/2	86 1/4	262	41	ITOQSTAR-2435	\$6,455
	24	34 1/2	86 1/4	262	41	ITOQSTAL-2435	\$6,455

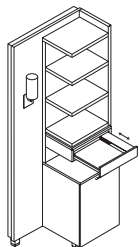

left shown with optional sconce

- use to create 86" h interactive wall
- four open fixed shelves
- laptop drawer with port power
- three blanks (for future data use)
- two adaptor kits to fit coupler/jacks
- storage compartment with one adjustable shelf for wall access
- wire management cut-out in pedestal opposite door hinge
- telescopic feet
- locking door available, specify and add \$105 list
- pull-out shelf in closed compartment available, specify and add \$220 list
- wall sconce available, specify and add \$312 list

86" h Storage Tower with Drawer	24	34 1/2	86 1/4	262	41	ITOQSTBR-2435	\$5,896
	24	34 1/2	86 1/4	262	41	ITOQSTBL-2435	\$5,896

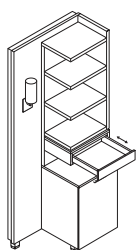

left shown with optional sconce

- use to create 86" h interactive wall
- four open fixed shelves and drawer
- storage compartment with one adjustable shelf for wall access
- wire management cut-out in pedestal opposite door hinge
- telescopic feet
- locking door available, specify and add \$105 list
- pull-out shelf in closed compartment available, specify and add \$220 list
- wall sconce available, specify and add \$312 list

86" h Storage Tower with Laptop Drawer	24	23 1/2	86 1/4	234	31	ITOQSTAR-2424	\$5,810
	24	23 1/2	86 1/4	234	31	ITOQSTAL-2424	\$5,810

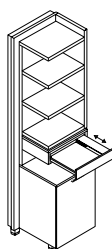

left shown

- use to create 86" h interactive wall
- four open fixed shelves
- laptop drawer with power port
- three blanks (for future data use)
- two adaptor kits to fit coupler/jacks
- storage compartment with one adjustable shelf for wall access
- wire management cut-out in pedestal opposite door hinge
- telescopic feet
- locking door available, specify and add \$105 list
- pull-out shelf in closed compartment available, specify and add \$220 list

86" h Storage Tower with Drawer	24	23 1/2	86 1/4	234	31	ITOQSTBR-2424	\$5,252
	24	23 1/2	86 1/4	234	31	ITOQSTBL-2424	\$5,252

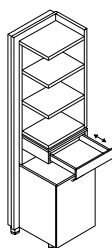

left shown

- use to create 86" h interactive wall
- four open fixed shelves and drawer
- storage compartment with one adjustable shelf for wall access
- wire management cut-out in pedestal opposite door hinge
- telescopic feet
- locking door available, specify and add \$105 list
- pull-out shelf in closed compartment available, specify and add \$220 list

COLLECTIVE PRESENTATION

Description	D	W	H	CTN WT	CU FT	① Model	List Price
86" h Refreshment Tower	26 1/2	24	86 1/4	234	32	ITOQRT1R-2724	\$4,946
	26 1/2	24	86 1/4	234	32	ITOQRT1L-2724	\$4,946

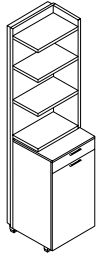

left shown

- use to create 86" h interactive wall
- four open fixed shelves
- storage drawer
- storage compartment with cut-out for ventilation or wall access
- wire management cut-out in pedestal opposite door hinge
- telescopic feet
- locking door available, specify and add \$105 list
- two adjustable shelves available, specify and add \$280
- open interior space: 20 1/2" d x 22 3/8" w x 31" h ▲

86" h Garage Tower	26 1/2	24	86 1/4	224	32	ITOQGT1R-2724	\$4,246
	26 1/2	24	86 1/4	224	32	ITOQGT1L-2724	\$4,246

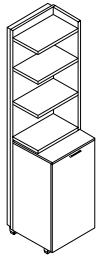

left shown

- use to create 86" h interactive wall
- four open fixed shelves
- stores mobile technology cart, see page 195 (order separately)r
- wire management cut-out in pedestal opposite door hinge
- telescopic feet
- locking door available, specify and add \$105 list
- open bottom: 20 1/2" d x 17" w ▲

86" h Tech Tower	26 1/2	20 1/2	86 1/4	226	29	ITOQNT1R-2721	\$3,893
	26 1/2	20 1/2	86 1/4	226	29	ITOQNT1L-2721	\$3,893

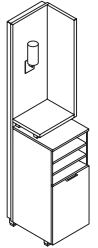

left shown with optional sconce

- use to create 86" h interactive wall
- one open fixed shelf
- aluminum spacers included
- open storage compartment with two fixed shelves
- closed storage compartment with one adjustable shelf for wall access
- wire management cut-out in pedestal opposite door hinge
- telescopic feet
- locking door available, specify and add \$105 list
- pull-out shelf in closed compartment available, specify and add \$220 list
- wall sconce available, specify and add \$312 list

To Order, Specify:

- ① Model Number
- ② Wood Species on Top/Chassis/Shelves -
Cherry (CH1), Makore (MK2), Maple (MA1),
Walnut (WA1) or Anegre Premium (AN5)
(see page 161)
- ③ Finish Color for Top/Chassis/Shelves (see page 161)
- ④ Finish Color for Back Panel and Door Front
A. Same as Top
B. Paint Color (see page 161)

Description	D	W	H	CTN WT	CU FT	① Model	List Price
74" h Storage Tower with Laptop Drawer	24	23 ½	74 ¼	222	29	ITOQSSAR-2424	\$4,754
	24	23 ½	74 ¼	222	29	ITOQSSAL-2424	\$4,754

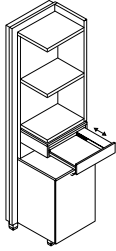

left shown

- use to create 74" h interactive wall
- three open fixed shelves
- laptop drawer with port power
- three blanks (for future data use)
- two adaptor kits to fit coupler/jacks
- storage compartment with one adjustable shelf for wall access
- wire management cut-out in pedestal opposite door hinge
- telescopic feet
- locking door available, specify and add \$105 list
- pull-out shelf in closed compartment available, specify and add \$220 list

74" h Storage Tower with Drawer	24	23 ½	74 ¼	222	29	ITOQSSBR-2424	\$4,199
	24	23 ½	74 ¼	222	29	ITOQSSBL-2424	\$4,199

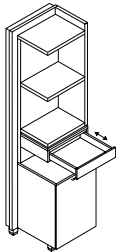

left shown

- use to create 74" h interactive wall
- three open fixed shelves and drawer
- storage compartment with one adjustable shelf for wall access
- wire management cut-out in pedestal opposite door hinge
- telescopic feet
- locking door available, specify and add \$105 list
- pull-out shelf in closed compartment available, specify and add \$220 list

Description	D	W	H	CTN WT	CU FT	① Model	List Price
74" h Refreshment/Storage Tower	26½	24	74¼	222	29	ITOQRS1R-2724	\$3,788
	26½	24	74¼	222	29	ITOQRS1L-2724	\$3,788

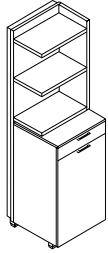

left shown

- use to create 74" h interactive wall
- three open fixed shelves
- storage drawer
- storage compartment with cut-out for ventilation or wall access
- wire management cut-out in pedestal opposite door hinge
- telescopic feet
- locking door available, specify and add \$105 list
- two adjustable shelves available, specify and add \$280
- open interior space: 20½" d x 22¾" w x 31" h ▲

74" h Garage Tower	26½	24	74¼	213	29	ITOQGS1R-2724	\$3,475
	26½	24	74¼	213	29	ITOQGS1L-2724	\$3,475

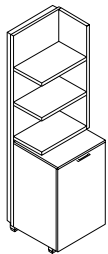

left shown

- use to create 74" h interactive wall
- three open fixed shelves
- stores mobile technology cart, see page 195 (order separately)
- wire management cut-out in pedestal opposite door hinge
- telescopic feet
- locking door available, specify and add \$105 list
- open bottom: 20½" d x 17" w ▲

74" h Tech Tower	26½	20½	74¼	219	26	ITOQNS1R-2721	\$3,117
	26½	20½	74¼	219	26	ITOQNS1L-2721	\$3,117

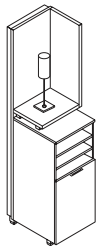

left shown with optional scionce

- use to create 74" h interactive wall
- one open fixed shelf
- aluminum spacers included
- open storage compartment with two fixed shelves
- closed storage compartment with one adjustable shelf for wall access
- wire management cut-out in pedestal opposite door hinge
- telescopic feet
- locking door available, specify and add \$105 list
- pull-out shelf in closed compartment available, specify and add \$220 list
- credenza lamp available, specify and add \$346 list

To Order, Specify:

- ① Model Number
- ② Wood Species on Top/Chassis/Shelves -
Cherry (CH1), Makore (MK2), Maple (MA1),
Walnut (WA1) or Anegre Premium (AN5)
(see page 161)
- ③ Finish Color for Top/Chassis/Shelves (see page 161)
- ④ Finish Color for Back Panel and Door/Drawer Front
A. Same as Top
B. Paint Color (see page 161)

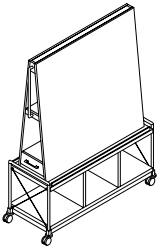
Description	D	W	H	CTN WT	CU FT	① Model	List Price Per Grade
Mobile Marker Board	20	51 1/2	71 3/4	227	50	MDOMMB1-2052	COM \$9,587
 <ul style="list-style-type: none"> · 48" x 48" porcelain enamel marker board · 48" x 48" tackable surface · handles for easy mobility · thumbs screws for flip chart · frame is arctic silver · 8 1/2" x 16" wood drawer boxes on each side · three lower open compartments · X-shaped steel cables on sides · two locking/two non-locking casters · com ydg: 1 3/4 							A \$9,605
							B \$9,638
							C \$9,698
							D \$9,776
							E \$9,853
							F \$9,972
							G \$10,100
							H \$10,238
							I \$10,451
							J \$10,707

Description	D	W	H	CTN WT	CU FT	① Model	List Price
Mobile Serving Cart	19	35 5/8	38 1/4	88	18	MDOMCS1-1936	\$6,521

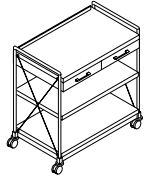

- handles for easy mobility
- frame is arctic silver
- top and bottom fixed shelves
- one adjustable shelf
- X-shaped steel cables on sides
- two locking/two non-locking casters

Mobile Technology Cart	15	17 3/8	38 1/4	32	8	MDOMCT1-1517	\$5,870
------------------------	----	--------	--------	----	---	--------------	---------

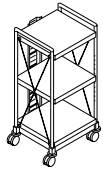

- handles for easy mobility
- frame is arctic silver
- top and bottom fixed shelves
- one adjustable shelf
- vertical wire management channel on back
- X-shaped steel cables on sides
- two locking/two non-locking casters

To Order, Specify:

- ① Model Number
- ② Wood Species on - Cherry (CH1), Makore (MK2), Maple (MA1), Walnut (WA1) or Anegre Premium (AN5) (see page 161)
- ③ Finish Color (see page 161)
- ④ Fabric - vendor, pattern, color

Finale Conference Product Information



FINALE

Finale Conference Product Information

Exterior Wood Materials

Exterior surfaces are made from the finest selected veneers to achieve clarity and consistency in the Finale product line. To attain a pleasing, symmetrical pattern, all veneers in Finale are book-matched. All exterior solid lumber is matched to coordinate with the veneer.

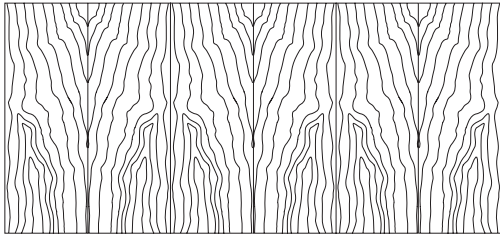

Book Matched Example

Alternating pieces of veneer are flipped over so they face each other like the pages within a book.

Finale is available in flat cut cherry, maple and walnut veneer. A wide range of wood stains have been formulated to enhance the beauty of the veneer.

Solid painted finishes on the veneer are also offered to provide an accent to the Finale product.

Work Surface Construction

Tops are 5-ply balanced construction, 1 3/16" thick with solid matching hardwood edges. Tops are available in six edge profile.

Matching or coordinating high pressure laminate in a veneer grain can be applied to the top surface and is available at no additional charge.

Base Construction

Panels are joined together by mortise and tenon construction. In addition to mortise and tenon joint construction. Leveling glides are set into solid hardwood with t-nut inserts, which helps to prevent the leveling glide from tear out. Tops are secured to the bases with top fastening cleats screwed to the inside of the panels.

Drawers

The 9ply unidirectional hardwood sides of the drawer box are 7/16" thick assembled with English dovetail construction at each corner of the box. The drawer bottom panel is 1/4" thick fitting into a groove machined into the side of the box. Interiors are sanded and coated with clear U.V. finish to protect against shrinking, swelling or warping, and to provide a clean, smooth feel and appearance.

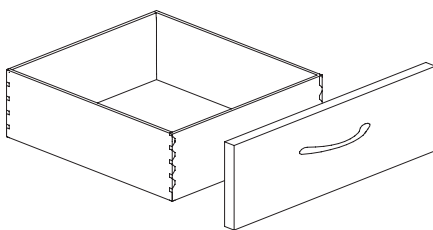

Drawer Suspension

The high quality black drawer suspensions carry a lifetime warranty. Slides feature steel ball bearings for longer life with cushioned in/out stops. File and box drawers have 100% full extension with over travel.

Finish - Stain/Colors

We offer a variety of wood stains and paint colors on Finale. Please see the chart below. Samples are available upon request. Former finish names are listed in parentheses for reference.

CH1 Cherry Flat Cut Veneer

AUT Autumn (<i>Autumn Cherry</i>)	EAR Earthy
BRL Barley	LGC Legacy (<i>Legacy Cherry</i>)
BBN Bourbon (<i>Natural Cherry</i>)	PRL Praline (<i>Vintage Cherry</i>)
BRG Brighton (<i>Brighton Cherry</i>)	SAF Saffron (<i>Medium Cherry</i>)
CLA Classic (<i>Classic Cherry</i>)	

MA1 Maple Flat Cut Veneer

ALE Ale (<i>Natural Maple</i>)	FLX Flax
BUT Butterscotch	VEN Venetian (<i>Dark Mahogany</i>)
CIN Cinnamon	

WA1 Walnut Flat Cut Veneer

AUB Auburn (<i>Windsor Mahogany</i>)	SIE Sienna
ESP Espresso	TOF Toffee
MCH Mocha	TRF Truffle
NTO Night Owl (<i>Vintage Walnut</i>)	

Protective Top Coat

DuraTex™ offers exceptional hardness along with abrasion and impact resistance, it has been formulated to eliminate hazardous and harmful gases that are normally associated with wood finish.

DuraTex™ Features

Safety - Significantly reduces hazardous formaldehyde emissions, which help improve the quality of the of the indoor air we breathe.

Quality - Developed to be tough and durable with special attention to appearance. The DuraTex™ finish preserves the natural beauty of wood.

Durability - Designed to meet a wide range of demanding performance and environmental standards to withstand even the highest wear and tear.

Finale Conference Product Information

Product Modification

Laminate Tops

Worksurface only, no additional upcharge if coordinating wood grain laminate is specified. Contact Customer Service for any other laminate request. Listed below are finishes that have coordinating wood grain HPL laminates.

Cherry Finishes	Maple Finishes	Walnut Finishes
<i>Autumn</i>	<i>Ale</i>	<i>Auburn</i>
<i>Barley</i>	<i>Cinnamon</i>	<i>Mocha</i>
<i>Bourbon</i>	<i>Venetian</i>	<i>Night Owl</i>
<i>Brighton</i>		<i>Sienna</i>
<i>Classic</i>		<i>Toffee</i>
<i>Legacy</i>		<i>Truffle</i>
<i>Praline</i>		
<i>Saffron</i>		

Special Finishes

Special finishes can be requested by following the instruction in the general introduction section, page 3. There is a one time charge of \$289 list per order.

Finish Sheen Modification

Finish sheen can be modified on the worksurface tops. There is a 15% upcharge added to the list of each item.

Oak Veneer

Upon request veneer can be changed from the standard offering to oak flat cut veneer with an additional 40% upcharge to the list of each item.

Finale Conference Product Information

Top Edge Details

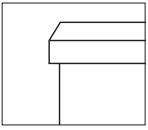

Bevel (B)▲

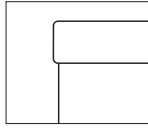

Eased (R4)▲

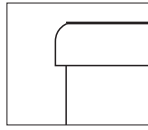

Gael (G)

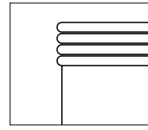

Reeded (H)

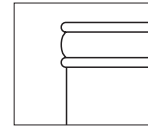

Transitional (C)

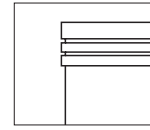

Triad (F)

Drawer Style Color Options

Finish Color MBK = Matte Black MNK = Matte Nickel MSL = Matte Silver



Arch
(MBK or MSL)



Block
(MNK)



Bow
(MNK)



Curve
(MNK)



Slotted
(MBK or MNK)



Twist
(MNK)

Top Shapes - size - base requirement - seating capacity

top sizes 108" through 192" are 2 pieces

top sizes above 192" are 3 pieces

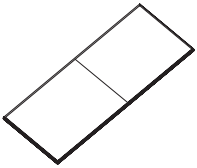

rectangular

264" x 60"	4 bases	seats 24
240" x 60"	4 bases	seats 22
216" x 60"	4 bases	seats 20
192" x 60"	3 bases	seats 18
264" x 54"	4 bases	seats 22
240" x 54"	4 bases	seats 20
216" x 54"	4 bases	seats 18
192" x 54"	3 bases	seats 16
264" x 48"	4 bases	seats 22
240" x 48"	4 bases	seats 20
216" x 48"	4 bases	seats 18
192" x 48"	3 bases	seats 16
168" x 48"	3 bases	seats 14
144" x 48"	3 bases	seats 12
120" x 48"	2 bases	seats 8
120" x 42"	2 bases	seats 8
108" x 42"	2 bases	seats 8
96" x 48"	2 bases	seats 8
96" x 42"	2 bases	seats 8
84" x 42"	2 bases	seats 8
72" x 36"	2 bases	seats 6

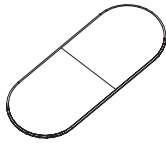

racetrack

264" x 60"	4 bases	seats 24
240" x 60"	4 bases	seats 22
216" x 60"	4 bases	seats 20
192" x 60"	3 bases	seats 18
264" x 54"	4 bases	seats 22
240" x 54"	4 bases	seats 20
216" x 54"	4 bases	seats 18
192" x 54"	3 bases	seats 16
264" x 48"	4 bases	seats 22
240" x 48"	4 bases	seats 20
216" x 48"	4 bases	seats 18
192" x 48"	3 bases	seats 16
168" x 48"	3 bases	seats 14
144" x 48"	3 bases	seats 12
120" x 48"	2 bases	seats 8
120" x 42"	2 bases	seats 8
108" x 42"	2 bases	seats 8
96" x 48"	2 bases	seats 8
96" x 42"	2 bases	seats 8
84" x 42"	2 bases	seats 8
72" x 36"	2 bases	seats 6

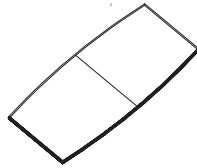

boat

264" x 60"	4 bases	seats 24
240" x 60"	4 bases	seats 22
216" x 60"	4 bases	seats 20
192" x 60"	3 bases	seats 18
264" x 54"	4 bases	seats 22
240" x 54"	4 bases	seats 20
216" x 54"	4 bases	seats 18
192" x 54"	3 bases	seats 16
264" x 48"	4 bases	seats 22
240" x 48"	4 bases	seats 20
216" x 48"	4 bases	seats 18
192" x 48"	3 bases	seats 16
168" x 48"	3 bases	seats 14
144" x 48"	3 bases	seats 12
120" x 48"	2 bases	seats 8
120" x 42"	2 bases	seats 8
108" x 42"	2 bases	seats 8
96" x 48"	2 bases	seats 8
96" x 42"	2 bases	seats 8
84" x 42"	2 bases	seats 8
72" x 36"	2 bases	seats 6



round*

60" dia.	Seats 6
54" dia.	Seats 6
48" dia.	Seats 4
42" dia.	Seats 4
36" dia.	Seats 4

*requires 1 base

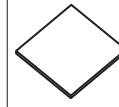

square*

60" sq.	seats 8
54" sq.	seats 6
48" sq.	seats 4
42" sq.	seats 4
36" sq.	seats 4
30" sq.	seats 4

*requires 1 base

Base (units with access panel in the base for wire management are available, order this feature with the appropriate model number.)

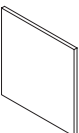

panel base
30" and 24" width

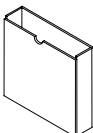

rectangle base
30" and 24" width

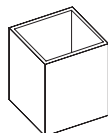

square base
24" and 18" width

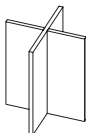

cross base
24" and 18" width

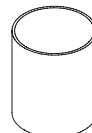

round base
24", 20" and 18" dia.



half-round base
24", 20 and 18" dia.

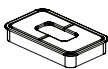

Worksurface Grommet

Additional worksurface grommets can be specified on veneer/laminate worksurfaces. The grommet location must be approved by JSI manufacturing, contact Customer Service. Add \$79 to the list for each additional grommet.

Grommet color must be specified, select Matte Black or Stardust Silver. Lock cores will match grommet color Matte Black (MBK) or Stardust Silver (STS).



End/Back Panel Grommet

The end/back panel grommets are standard, for any special consideration contact Customer Service.

Finale Conference Product Information

Finish and Product Reference Codes

Select Code

Veneer

Cherry Flat Cut	CH1
Maple Flat Cut	MA1
Walnut Flat Cut	WA1

Finish

Cherry Finishes

Autumn	AUT
Barley	BRL
Bourbon	BBN
Brighton	BRG
Classic	CLA
Earthy	EAR
Legacy	LGC
Praline	PRL
Saffron	SAF

Maple Finishes

Ale	ALE
Butterscotch	BUT
Cinnamon	CIN
Flax	FLX
Venetian	VEN

Select Code

Walnut Finishes

Auburn	AUB
Espresso	ESP
Mocha	MCH
Night Owl	NTO
Sienna	SIE
Toffee	TOF
Truffle	TRF

Top Edge Details

Bevel	B
Eased	R4
Gael	G
Reeded	H
Transitional	C
Triad	F

Pull & Finish Codes

Arch - Matte Nickel	MNK
Arch - Matte Silver	MSL
Block - Matte Nickel	MNK
Bow - Matte Nickel	MNK
Curve - Matte Nickel	MNK
Slotted - Matte Black	MBK
Slotted - Matte Nickel	MNK
Twist - Matte Nickel	MNK

Select Code

Laminate Coordinators

Cherry Wood Grain Patterns

Autumn	AUT
Barley	BRL
Bourbon	BBN
Brighton	BRG
Classic	CLA
Legacy	LGC
Praline	PRL
Saffron	SAF

Maple Wood Grain Patterns

Ale	ALE
Cinnamon	CIN
Venetian	VEN

Walnut Wood Grain Patterns

Auburn	AUB
Mocha	MCH
Night Owl	NTO
Sienna	SIE
Toffee	TOF
Truffle	TRF





Metal Finish *(grommet)*

Matte Black	MBK
Stardust Silver	STS

Order Check List:

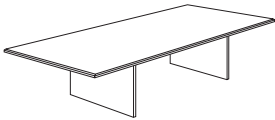
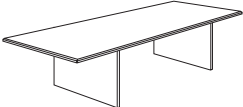
Specify:

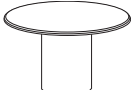
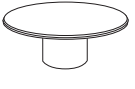
- 1. Model Number
- 2. Finish
- 3. Wood Species - cherry - makore - maple - walnut
- 4. Top Options - standard veneer - laminate surface (see page 199)
- 5. Other Product Options
- 6. Power and Data Accessories (*drawing showing location and orientation must accompany order*)
- 7. Side Mark Information (*i.e. room number, East Conference Room*)
- 8. Shipping Address (*contact name and phone number*)
- 9. Special Delivery Instructions (*i.e. call before delivery, deliver to job site*)

Description	D	W	H	CTN WT	CU FT	① Model	List Price
Conference Table	42	96	30			FN4296CTP	\$3,958
 <p>NOW!</p> <ul style="list-style-type: none"> ships KD in four cartons one piece top price reflects two bases price includes one FN0655SP stretcher panel must order (2) panel bases 					Consists of:		
			172	15	FN4296TT - Table Top	\$2,908	
			54 ea.	4 ea.	FN2428PB - Panel Bases	\$1,050	
Conference Table	36	72	30			FN3672CTP	\$2,919
 <p>NOW!</p> <ul style="list-style-type: none"> ships KD in four cartons one piece top price reflects two bases price includes one FN0631SP stretcher panel must order (2) panel bases 					Consists of:		
			110	10	FN3672TT - Table Top	\$1,869	
			54 ea.	4 ea.	FN2428PB - Panel Bases	\$1,050	
Round Conference Table	48	48	30			FN48CTD	\$2,259
 <p>NOW!</p> <ul style="list-style-type: none"> ships KD in two cartons 					Consists of:		
			73	7	FN48TT - Table Top	\$1,455	
			71	9	FN20RB - Round Base	\$804	
Round Conference Table	42	42	30			FN42CTD	\$1,915
 <p>NOW!</p> <ul style="list-style-type: none"> ships KD in two cartons 					Consists of:		
			56	5	FN42TT - Table Top	\$1,111	
			71	9	FN20RB - Round Base	\$804	
Round Conference Table	42	42	16			FN42MTD	\$1,863
 <p>NOW!</p> <ul style="list-style-type: none"> ships KD in two cartons 					Consists of:		
			73	7	FN42TT - Table Top	\$1,111	
			68	5	FN18-16RB - Round Base	\$752	
Round Conference Table	36	36	16			FN36MTD	\$1,730
 <p>NOW!</p> <ul style="list-style-type: none"> ships KD in two cartons 					Consists of:		
			42	4	FN36TT - Table Top	\$978	
			68	5	FN18-16RB - Round Base	\$752	

To Order, Specify:

- ① Model Number
- ② Wood Species
 - A. Work Surface
 - B. Chassis
- ③ Finish Color
 - A. Work Surface
 - B. Chassis
- ④ Edge Profile
- ⑤ Power and Data Options (see page 322)
- ⑥ Other Product Options

When ordering Quickship products, place a "Q" in front of model number.
Example: QV3072DD



NOW!
Need it.
JSI Quickship

Description	① Model	W	L	Seat Capacity	Top Pieces	Bases Required	CTN WT	CU FT	List Price
Rectangular Tops 	FN60264TT	60	264	24	3	4	673	57	\$12,280
	FN60240TT	60	240	22	3	4	613	51	\$11,163
	FN60216TT	60	216	20	3	4	552	48	\$10,050
	FN60192TT	60	192	18	2	3	490	42	\$8,931
	FN54264TT	54	264	22	3	4	609	52	\$10,234
	FN54240TT	54	240	20	3	4	554	50	\$9,303
	FN54216TT	54	216	18	3	4	498	43	\$8,375
	FN54192TT	54	192	16	2	3	441	38	\$7,443
	FN48264TT	48	264	22	3	4	548	47	\$9,099
	FN48240TT	48	240	20	3	4	498	43	\$8,272
	FN48216TT	48	216	18	3	4	447	38	\$7,443
	FN48192TT	48	192	16	2	3	396	33	\$6,618
	FN48168TT	48	168	14	2	3	346	30	\$5,791
	FN48144TT	48	144	12	2	3	296	28	\$4,964
	FN48120TT**	48	120	8	2	2	245	22	\$4,137
	FN4896TT	48	96	8	1	2	197	17	\$3,324
	FN42120TT**	42	120	8	2	2	217	19	\$3,620
	FN42108TT	42	108	8	2	2	195	17	\$3,260
	FN4296TT	42	96	8	1	2	172	15	\$2,908
	FN4284TT	42	84	8	1	2	151	13	\$2,531
FN3672TT	36	72	6	1	2	110	10	\$1,869	

**When ordering RECTANGLE or PANEL BASES - FN48120 and FN42120 require (3) panel bases and additional stretchers. Stretchers will be included as required.

Description	① Model	W	L	Seat Capacity	Top Pieces	Bases Required	CTN WT	CU FT	List Price
Racetrack Tops 	FN60264RT	60	264	24	3	4	646	57	\$14,511
	FN60240RT	60	240	22	3	4	589	51	\$13,193
	FN60216RT	60	216	20	3	4	530	48	\$11,875
	FN60192RT	60	192	18	2	3	471	42	\$10,556
	FN54264RT	54	264	22	3	4	586	52	\$12,093
	FN54240RT	54	240	20	3	4	530	50	\$10,994
	FN54216RT	54	216	18	3	4	474	43	\$9,896
	FN54192RT	54	192	16	2	3	417	38	\$8,796
	FN48264RT	48	264	22	3	4	529	47	\$10,750
	FN48240RT	48	240	20	3	4	479	43	\$9,774
	FN48216RT	48	216	18	3	4	428	38	\$8,796
	FN48192RT	48	192	16	2	3	377	33	\$7,819
	FN48168RT	48	168	14	2	3	327	30	\$6,760
	FN48144RT	48	144	12	2	3	277	28	\$5,866
	FN48120RT**	48	120	8	2	2	226	22	\$4,891
	FN4896RT	48	96	8	1	2	185	17	\$3,912
	FN42120RT**	42	120	8	2	2	203	19	\$4,277
	FN42108RT	42	108	8	2	2	180	17	\$3,851
	FN4296RT	42	96	8	1	2	157	15	\$3,422
	FN4284RT	42	84	8	1	2	142	13	\$3,007
FN3672RT	36	72	6	1	2	100	10	\$2,204	

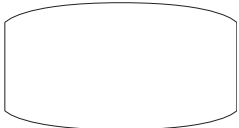
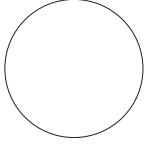
**When ordering RECTANGLE or PANEL BASES - FN48120 and FN42120 require (3) panel bases and additional stretchers. Stretchers will be included as required.

Description	① Model	W	L	Seat Capacity	Top Pieces	Bases Required	CTN WT	CU FT	List Price
Boat Shape Tops  • boat shape top end dimension is 6" less than center dimension **When ordering RECTANGLE or PANEL BASES - FN48120 and FN42120 require (3) panel bases and additional stretchers. Stretchers will be included as required.	FN60264BT	60	264	24	3	4	646	57	\$14,511
	FN60240BT	60	240	22	3	4	589	51	\$13,193
	FN60216BT	60	216	20	3	4	530	48	\$11,875
	FN60192BT	60	192	18	2	3	471	42	\$10,556
	FN54264BT	54	264	22	3	4	586	52	\$12,093
	FN54240BT	54	240	20	3	4	530	50	\$10,994
	FN54216BT	54	216	18	3	4	474	43	\$9,896
	FN54192BT	54	192	16	2	3	417	38	\$8,796
	FN48264BT	48	264	22	3	4	529	47	\$10,750
	FN48240BT	48	240	20	3	4	479	43	\$9,774
	FN48216BT	48	216	18	3	4	428	38	\$8,796
	FN48192BT	48	192	16	2	3	377	33	\$7,819
	FN48168BT	48	168	14	2	3	327	30	\$6,760
	FN48144BT	48	144	12	2	3	277	28	\$5,866
	FN48120BT**	48	120	8	2	2	226	22	\$4,891
	FN4896BT	48	96	8	1	2	185	17	\$3,912
	FN42120BT**	42	120	8	2	2	203	19	\$4,277
	FN42108BT	42	108	8	2	2	180	17	\$3,851
	FN4296BT	42	96	8	1	2	157	15	\$3,422
	FN4284BT	42	84	8	1	2	142	13	\$3,007
FN3672BT	36	72	6	1	2	100	10	\$2,204	
Round Tops 	FN60TT	60	N/A	6	1	1	112	10	\$2,461
	FN54TT	54	N/A	6	1	1	92	8	\$1,847
	FN48TT	48	N/A	4	1	1	73	7	\$1,455
	FN42TT	42	N/A	4	1	1	56	5	\$1,111
	FN36TT	36	N/A	3	1	1	42	4	\$978
	FN30TT	30	N/A	3	1	1	30	3	\$863
	Square Tops 	FN6060TT	60	60	8	1	1	154	10
FN5454TT		54	54	6	1	1	125	8	\$1,706
FN4848TT		48	48	4	1	1	99	7	\$1,347
FN4242TT		42	42	4	1	1	77	5	\$1,032
FN3636TT		36	36	4	1	1	56	4	\$931
FN3030TT		30	30	4	1	1	39	3	\$647

To Order, Specify:



- ① Model Number
- ② Wood Species
- ③ Finish Color
- ④ Edge Profile
- ⑤ Power and Data Options (see page 322)
- ⑥ Other Product Options



When ordering Quickship products, place a "Q" in front of model number.
 Example: QVV3072DD



NOW!
Need it.
 JSI Quickship

FINALE

Description	D	W	H	CTN WT	CU FT	① Model	List Price
Panel Base 	2 5/16	36	28 3/4	83	6	FN3628PB	\$632
	2 5/16	30	28 3/4	68	5	FN3028PB · for use with 54" width top	\$580
	2 5/16	24	28 3/4	54	4	FN2428PB · for use with 36", 42" and 48" width top · (3) bases are required when ordering FN48120 or FN42120	\$525

Description	D	W	H	CTN WT	CU FT	① Model	List Price
Rectangle Base   side 1 side 2	7 5/8	36	28 3/4	69	7	FN3628PBA	\$1,067
	7 5/8	30	28 3/4	60	6	FN3028PBA · for use with 54" width top · access panel	\$1,015
	7 5/8	24	28 3/4	52	5	FN2428PBA · for use with 36", 42" and 48" width top · access panel · (3) bases are required when ordering FN48120 or FN42120	\$958

Description	D	W	H	CTN WT	CU FT	① Model	List Price
Round Base 	24	N/A	28 3/4	74	12	FN24RB · for use with 54" and 60" width top	\$915
	24	N/A	28 3/4	37	12	FN24RBA · for use with 54" and 60" width top · access panel	\$1,022
	20	N/A	28 3/4	71	9	FN20RB  · for use with 42" and 48" width top	\$804
	20	N/A	28 3/4	34	9	FN20RBA · for use with 42" and 48" width top · access panel	\$912
	18	N/A	28 3/4	68	7	FN18RB · for use with 36" width top	\$752
	18	N/A	28 3/4	31	7	FN18RBA · for use with 36" width top · access panel	\$860

Description	D	W	H	CTN WT	CU FT	① Model	List Price
Half Round Base 	12	24	28 3/4	35	6	FN24HRB · for use with 54" width top	\$691
	12	24	28 3/4	33	6	FN24HRBA	\$813
	10	20	28 3/4	30	5	FN20HRB · for use with 42" and 48" width top	\$630
	10	20	28 3/4	28	5	FN20HRBA	\$754
	9	18	28 3/4	27	4	FN18HRB · for use with 36" width top	\$604
	9	18	28 3/4	26	4	FN18HRBA	\$730
	Square Base 	30	30	28 3/4	83	6	FN30SB
30		30	28 3/4	68	16	FN30SBA	\$973
24		24	28 3/4	68	12	FN24SB · for use with 54" and 60" width top	\$763
24		24	28 3/4	68	12	FN24SBA · for use with 54" and 60" width top · access panel	\$871
18		18	28 3/4	39	7	FN18SB · for use with 36", 42" and 48" width top	\$658
18		18	28 3/4	39	7	FN18SBA · for use with 30", 42" and 48" width top · access panel	\$766
Cross Base 		30	30	28 3/4	80	16	FN30XB
	24	24	28 3/4	80	12	FN24XB · for use with 48", 54" and 60" width top	\$644
	18	18	28 3/4	50	7	FN18XB · for use with 36" and 42" width top	\$575

To Order, Specify:

- ① Model Number
- ② Wood Species
- ③ Finish Color
- ④ Power and Data Options (see page 322)
- ⑤ Other Product Options

When ordering Quickship products, place a "Q" in front of model number.
Example: QV3072DD



Description	D	W	H	CTN WT	CU FT	① Model	List Price
Conference Lectern	23	27	48	250	23	FN2622LEC	\$2,447

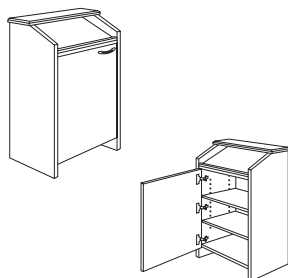

- two adjustable shelves
- four concealed, locking casters
- door non-locking
- standard door is hinged on left
- round grommet in bottom panel
- notches in adjustable shelves allow wires to pass through

Visual Board	3 ½	48	48	125	8	FN4848VB	\$2,840
---------------------	-----	----	----	-----	---	-----------------	----------------

NOW!

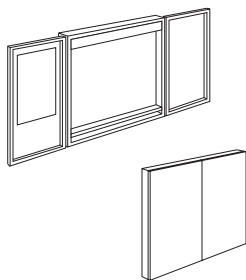

- corkboard on right and left doors; paper pad on left only
- marker board in center
- four markers and eraser included
- optional face applied pulls
- locking not available

Buffet Credenza	24	71 ¾	36	280	43	FN2472BSC	\$4,329
------------------------	----	------	----	-----	----	------------------	----------------

NOW!



- top edge profile on user side
- four door credenza
- four box drawers above doors
- locking doors and drawers not available
- adjustable shelf in storage cabinet
- two end panel grommets with wire pass thru
- flat screen mounting grommets in top
- back panel includes cord exit grommets

Buffet Credenza - Flat Screen Support	24	71 ¾	36	280	43	FN2472BSCT	\$4,700
--	----	------	----	-----	----	-------------------	----------------

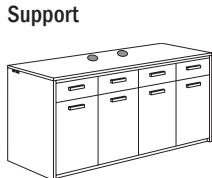

- top edge profile on user side
- four door credenza
- four box drawers above doors
- locking doors and drawers not available
- adjustable shelf in storage cabinet
- two end panel grommets with wire pass thru
- flat screen mounting grommets in top
- back panel includes cord exit grommets

Flat Screen Mounting Frame	2	14	55	35	4	FSTV	\$1,236
-----------------------------------	---	----	----	----	---	-------------	----------------

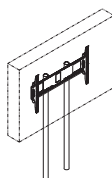

- round 2" tube frame with cable management to inside of credenza
- mounting bracket for TV provided (see page 322)
- available in black (B) or silver (S)
- TV not included
- coordinates with FN2472BSCT

Description	D	W	H	CTN WT	CU FT	1 Model	List Price
72" h File/File Lateral Storage Cabinet	24	35 ³ / ₈	72	360	43	FN3672SWLF	\$3,585

NOW!

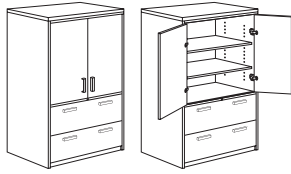

- two adjustable shelves
- locking doors available; specify and add \$105 list
- top edge profile on user side only
- file/file lateral
- pedestal locking

72" h Wardrobe	24	35 ³ / ₈	72	360	41	FN3672W	\$2,779
----------------	----	--------------------------------	----	-----	----	---------	---------

NOW!

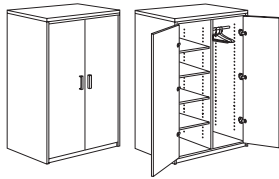

- top edge profile on user side
- chrome hanging bar on right
- one fixed shelf second from bottom on left
- locking doors available; specify and add \$210 list

Hanging Bar to Shelves Conversion Kit	24	18	¾	56	2	FN1824SK	\$634
---------------------------------------	----	----	---	----	---	----------	-------

NOW!

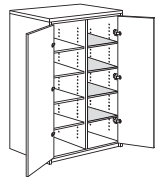

- four shelves
- for 36" wide wardrobe

To Order, Specify:

- 1 Model Number
- 2 Wood Species
- 3 Finish Color
- 4 Edge Profile
- 5 Pull (style and color)
- 6 Grommet Color
- 7 Power and Data Options (see page 322)
- 8 Other Product Options

When ordering Quickship products, place a "Q" in front of model number.
Example: QVW3072DD

NOW!
Need it.
JSI Quickship

Description	D	W	H	CTN WT	CU FT	① Model	List Price
72" h File/File Storage Wardrobe	24	23 5/8	72	340	29	FN2472SWR	\$2,617
	24	23 5/8	72	340	29	FN2472SWL	\$2,617

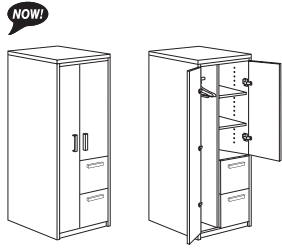

- top edge profile on user side
- chrome hanging bar
- two adjustable shelves
- file/file pedestal
- locking not available

left shown

Description	D	W	H	CTN WT	CU FT	① Model	List Price
72" h Wardrobe	24	18	72	233	23	FN1872WR	\$2,328
	24	18	72	233	23	FN1872WL	\$2,328

NOW!

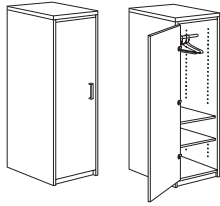

left shown

- top edge profile on user side
- chrome hanging bar at top
- one fixed shelf 26 1/2" from cabinet floor
- one adjustable shelf
- locking doors available; specify and add \$105 list

To Order, Specify:

- ① Model Number
- ② Wood Species
- ③ Finish Color
- ④ Edge Profile
- ⑤ Pull (style and color)
- ⑥ Grommet (style and color)
- ⑦ Power and Data Options (see page 322)
- ⑧ Other Product Options

When ordering Quickship products, place a "Q" in front of model number.
Example: QV3072DD





iXY Product Information

Exterior Wood Materials

Exterior surfaces are made from the finest selected veneers to achieve clarity and consistency in the iXY product line. To attain a pleasing, symmetrical pattern, all veneers in iXY are book-matched. All exterior solid lumber is matched to coordinate with the veneer.

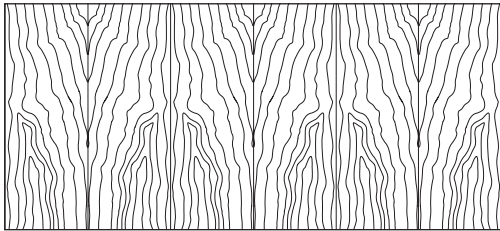

Book Matched Example

Alternating pieces of veneer are flipped over so they face each other like the pages within a book. The diagram above shows book-matched flat cut veneer.

iXY is available in flat cut cherry, maple and walnut veneer. A wide range of wood stains have been formulated to enhance the beauty of the veneer.

Double Cut veneer is another choice on iXY product. This veneer is a processed product that has at least two cuttings to create the final veneers. These cuts of veneer strands are dyed and layered into a block to create variation of patterns from a very tight grain pattern to an exotic figure grain pattern. The diagram below show the tight pattern used on iXY.

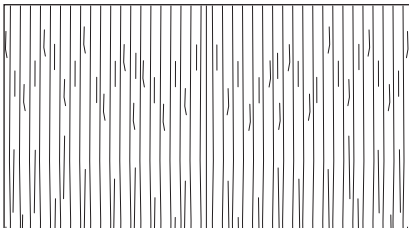

Solid painted finishes on MDF are also offered to provide an accent to the iXY product.

Table Frames

Die-cast aluminum corners with receivers for table rails and legs, attached to underside of the top. Table rails are extruded aluminum with allowance for optional features. Legs, die-cast aluminum with wire cavity and clip features to secure the wires. Glide has approximately 1" of adjustment and shroud ring to conceal threads.

Veneer Table Tops

Tops are 1 1/4" thick 3 ply with MDF core. Edges on table tops are undercut bevel with the 3/8" flat having a 1.5 mm matching self rim. Tops are secured with core fastening screws to the table rails. Two inch radius corners are on top shapes.

Primary Height Case Tops

Tops are 1 3/16" thick, 3 ply construction with a solid lumber band on user side and 1.5 mm veneer tape. Tops are securely fastened with screws through the pedestal stretcher and metal connecting plates.

Table with Glass Tops

Tops can be either clear or back painted opaque where applicable. Glass is 10 mm thick with a 1/32" bevel on both the top and bottom edges. Glass is low iron and tempered for safety. A series of small pucks are attached to the underside with an adhesive. These pucks then rest on the table rails.

Case Construction

Cases are constructed with a combination of mortise-tenon and dowels to secure joints of the case. Panels are 3/4" thick 3 ply construction. Reinforced metal corner braces secure corners and house the leveler.

Back of cases can be fixed 3/4" thick stationary or 1/4" thick removable. (Check individual items specification listing) Backs of cases are always finished.

Glides have a full adjustment 1 1/2" to allow for proper leveling.

Drawers

Standard V-fold drawer interior is a 1/2" durable, miter-fold drawer system. The four sided box is mitered, glued and doweled with an attached front. The drawer front is veneer rimmed MDF core and is attached to the four sided box. Routed bevel pull creates a self pull. Prism pull is available as an option

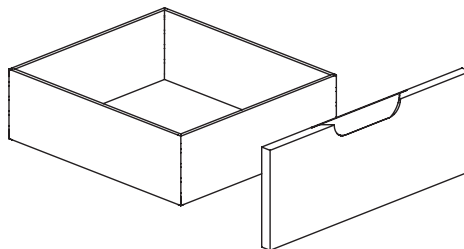

Drawer Suspension

High quality black drawer suspension carries a lifetime warranty. Ball bearing provide a smooth effortless access to the drawers. All drawers have soft close feature with the exception of lateral files. File drawers have provisions for legal and letter filing. Lateral file drawers have reinforced bottoms.

Locking

All drawers have locks as standard. The locks are pedestal locking, located in the upper right corner of the top drawer. Locks are optional on most door compartments.

Units are shipped randomly keyed as standard (units in the grouping are keyed alike). Keyed alike units available if requested at no upcharge. Removable cores for in-field re-keying are standard.

Doors

Hinge doors have a 110° swing with the soft close feature.

Sliding doors have a single pass hidden roller wheel with guide tracks. Locking is not available on sliding door units.

Overheads can be ordered with the optional back painted glass doors in a thin profile aluminum frame. Locks are not available on glass doors.

iXY Product Information

Adjustable Height Worksurface

Single lift column adjust worksurface up to 42 ¼" height. Control is flush mounted into the top of pedestal. Control for the Table Desk can be mounted either left or right of the top's center. Aluminum profile housing encloses the UL® certified driver and mechanism.

Pull-Out Shelf

Equipment can easily be accessed by specifying the pull out shelf option. This shelf is always located at the bottom of the cabinet and has a front stop rail incorporated as part of the shelf. The slide extensions are undermounts to provide a clean appearance.

Finish - Stain/Colors

We offer a variety of wood stains and paint colors on iXY. Please see the chart below. Samples are available upon request. Former finish names are listed in parentheses for reference.

CH1 Cherry *Flat Cut Veneer*

AUT Autumn (<i>Autumn Cherry</i>)	EAR Earthy
BRL Barley	LGC Legacy (<i>Legacy Cherry</i>)
BBN Bourbon (<i>Natural Cherry</i>)	PRL Praline (<i>Vintage Cherry</i>)
BRG Brighton (<i>Brighton Cherry</i>)	SAF Saffron (<i>Medium Cherry</i>)
CLA Classic (<i>Classic Cherry</i>)	

MA1 Maple *Flat Cut Veneer*

ALE Ale (<i>Natural Maple</i>)	FLX Flax
BUT Butterscotch	VEN Venetian (<i>Dark Mahogany</i>)
CIN Cinnamon	

WA1 Walnut *Flat Cut Veneer*

AUB Auburn (<i>Windsor Mahogany</i>)	SIE Sienna
ESP Espresso	TOF Toffee
MCH Mocha	TRF Truffle
NTO Night Owl (<i>Vintage Walnut</i>)	

DC1 Double Cut Veneer

COF Coffee	KHK Khaki
CRM Cremello	STU Studio Teak
GRH Graphite	

PNT Paint *Maple Flat Cut Veneer*

BKD Backdrop	GRV Greek Villa
BFX Black Fox	NET Network Gray
BWH Bright White	NWH Nonchalant White
CGP Cargo Pants	STM Storm
CHT Chatroom	TRC Tricorn Black
FRR French Roast	

Protective Top Coat

DuraTex™ offers exceptional hardness along with abrasion and impact resistance, it has been formulated to eliminate hazardous and harmful gases that are normally associated with wood finish.

DuraTex™ Features

Safety - Significantly reduces hazardous formaldehyde emissions which help improve the quality of the of the indoor air we breathe.

Quality - Developed to be tough and durable with special attention to appearance. The DuraTex™ finish preserves the natural beauty of wood.

Durability - Designed to meet a wide range of demanding performance and environmental standards to withstand even the highest wear and tear.

Special Finishes

Special finishes can be requested by following the instruction in the general introduction section, page 3. There is a one time charge of \$289 list per order.

iXY Product Information

Edge Profiles

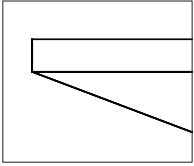

Worksurface Edge Profile
Tables
Adjustable Height Worksurface

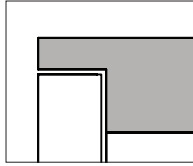

Storage Edge Profile
Primary Height Storage

Pulls + Finish Selection

Note: Pulls below the worksurface top are always horizontal; pulls above the worksurface top are vertical.

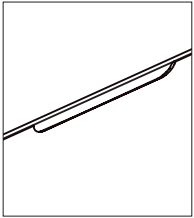

Recessed on Lower Storage
(Standard)
Arctic Silver
Bright White

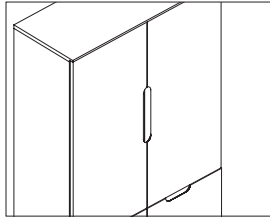

Recessed on Upper Storage
(Standard)
Arctic Silver
Bright White

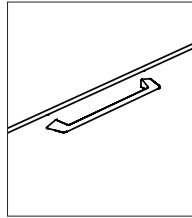

Prism on Lower Storage
(Optional)
Chrome
Matte Nickel

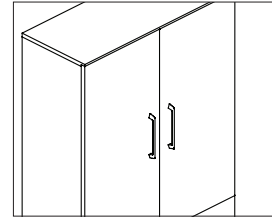

Prism on Upper Storage
(Optional)
Chrome
Matte Nickel

Legs & Rails + Finish

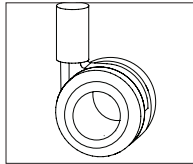
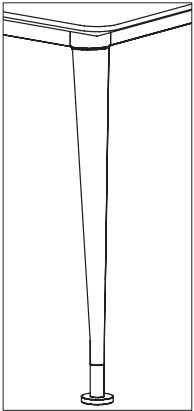

Caster
**Not available with glass top

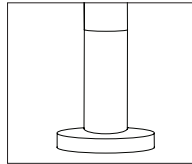

Glide
Polished Aluminum Frame - Chrome Glide
Arctic Silver/Bright White Frame - Arctic Silver Glide

Legs

Arctic Silver
Bright White
Polished Aluminum - \$462 list upcharge per table
Coordinating table rail finish is determined by leg finish.

iXY Product Information

Optional Worksurface Grommet

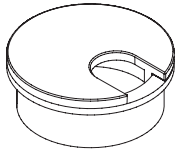

Matte Nickel
(MNK)

Worksurface Grommet Locations

The optional grommet locations on the desk, run-off desk and credenzas are predetermined. Grommet locations are indicated below with an (A) for left, (B) for center, (C) for right.

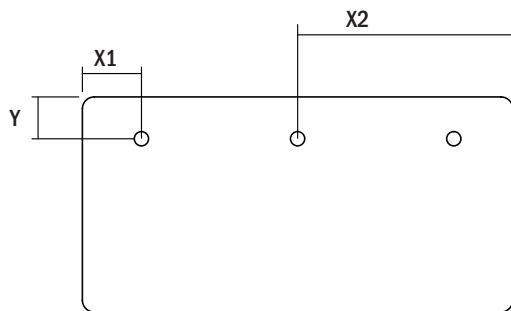

X1 = 9 7/8"
X2 = Center
Y1 = 7"

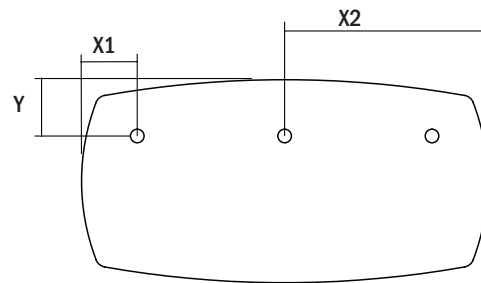

X1 = 9 7/8"
X2 = Center
Y = 10"

Credenzas

Center grommet is available on open corner lateral and kneespace credenzas.

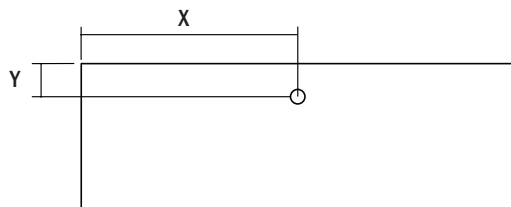

X = Center
Y = 5 1/2"

iXY Product Information

Table Desk Top Shapes



Rectangular
Freestanding
Adjustable Height

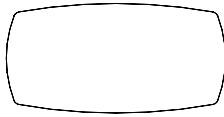

Bow
Freestanding
Adjustable Height

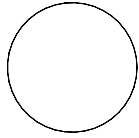

Round
Freestanding
Adjustable Height

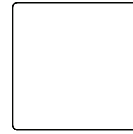

Square
Freestanding
Adjustable Height

Tables

Offering includes Freestanding, Adjustable Height, Pedestal Supported Pivoting or Pedestal Supported Fixed Table Desk.



Freestanding Tables
29 1/4" h Worksurface Height
Veneer
Back Painted White Glass
Clear Glass (low iron)



Adjustable Height Tables
29 3/4" - 42 1/4" h Worksurface Height
Veneer



Fixed Height Tables
29 1/4" h Worksurface Height
Veneer

Finish Features and Options

Tables

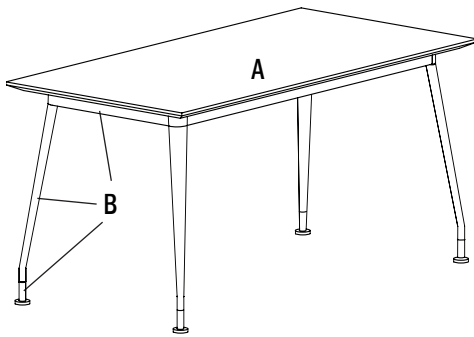

- A Worksurface**
 - Veneer
 - Clear Glass
 - Glossy Low Iron White Back Painted Glass
 - (note: glass not available in all configurations)*
- B Frame**
 - Scheme 1
 - Legs & Apron Rails - Arctic Silver
 - Glides - Arctic Silver
 - Scheme 2
 - Legs & Apron Rails - Bright White
 - Glides - Arctic Silver
 - Scheme 3
 - Legs - Polish Aluminum
 - Apron Rails - Bright Aluminum
 - Glides - Chrome

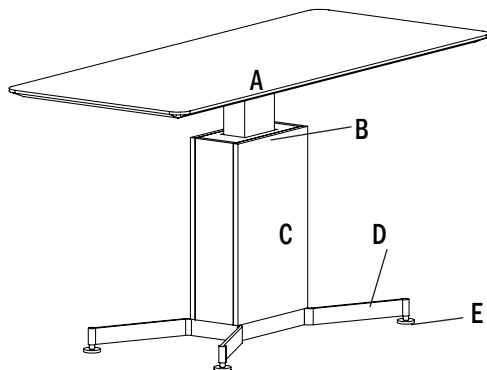

- A Worksurface** - Veneer
- B Lift** - Anodized Aluminum
- C Chassis** - Veneer or Paint
- D Legs/Base** - Arctic Silver or Bright White
- E Glides** - Arctic Silver

iXY Product Information

Wire Extrusion Channel

Leg cavity allows wiring to be routed along the inside of the leg to the floor, clips are provided with each leg

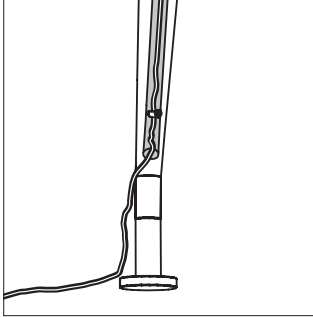

Control Button

The secondary adjustable height has a surface mounted control button to move the worksurface from 29 3/4" to 42 1/4" h.

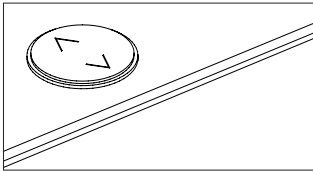

Surface Power Unit

- (2) Power Outlets, 72" cord,
- (1) USB 2-Port Simplex Charger,
- (1) Passive USB-A, 3.0 with 72" Cable

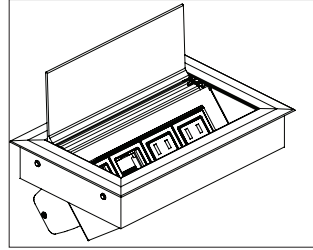

Glass Doors

Thin anodized aluminum profile, with glossy low iron white back painted glass.

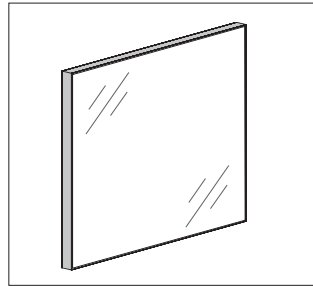

iXY Product Information

Finish and Product Reference Codes

Select	Code
--------	------

Veneer

Cherry Flat Cut	MK1
Maple Flat Cut	MA1
Walnut Flat Cut	WA1
Double Cut	DC1

Finish

Cherry Finishes

Autumn	AUT
Barley	BRL
Bourbon	BBN
Brighton	BRG
Classic	CLA
Earthy	EAR
Legacy	LGC
Praline	PRL
Saffron	SAF

Maple Finishes

Ale	ALE
Butterscotch	BUT
Cinnamon	CIN
Flax	FLX
Venetian	VEN

Walnut Finishes

Auburn	AUB
Espresso	ESP
Mocha	MCH
Night Owl	NTO
Sienna	SIE
Toffee	TOF
Truffle	TRF

Select	Code
--------	------

Double Cut Finishes

Coffee	COF
Cremello	CRM
Graphite	GRH
Khaki	KHK
Studio Teak	STU

Paint Finishes

Backdrop	BKD
Black Fox	BFX
Bright White	BWH
Cargo Pants	CGP
Chatroom	CHT
French Roast	FRR
Greek Villa	GRV
Network Gray	NET
Nonchalant White	NWH
Storm	STM
Tricorn Black	TRC

Pulls & Finishes

Recess - Arctic Silver	ASL
Recess - Bright White	BWH
Prism - Chrome	CHR
Prism - Matte Nickel	MNK

Leg & Rail Options

- a. Legs & Rails Arctic Silver
- b. Legs & Rails Bright White
- c. Legs
 - Polished Aluminum
 - Rails
 - Bright Anodized Aluminum

Select	Code
--------	------

Laminate Coordinates

Cherry Wood Grain Patterns

Autumn	AUT
Barley	BRL
Bourbon	BBN
Brighton	BRG
Classic	CLA
Legacy	LGC
Praline	PRL
Saffron	SAF

Maple Wood Grain Patterns

Ale	ALE
Cinnamon	CIN
Venetian	VEN

Walnut Wood Grain Patterns

Auburn	AUB
Mocha	MCH
Night Owl	NTO
Sienna	SIE
Toffee	TOF
Truffle	TRF

Glass Top Finishes

- Clear
- Glossy Low Iron
- White Back Painted

Order Check List:

Specify:

- 1. Model Number
- 2. Finish Scheme/Color (see page 218)
- 3. Wood Species - cherry - maple - walnut
- 4. Top Options - standard veneer - back painted white glass
- 5. Other Product Options
- 6. Power and Data Accessories (specify location see page 322)
- 7. Side Mark Information (*i.e.* room number, East Conference Room)
- 8. Shipping Address (*contact name and phone number*)
- 9. Special Delivery Instructions (*i.e.* call before delivery, deliver to job site)

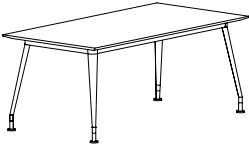
Description	D	W	H	CTN WT	CU FT	① Model	Wood	Clear Glass	Back Painted Glass
	36	78	29 1/4	156	57	DY1-TDR-1-3678	\$2,888	\$4,988	\$5,471
	36	72	29 1/4	131	52	DY1-TDR-1-3672	\$2,772	\$4,710	\$5,156
	36	66	29 1/4	125	48	DY1-TDR-1-3666	\$2,688	\$4,463	\$4,872
	30	78	29 1/4	124	48	DY1-TDR-1-3078	\$2,793	\$4,536	\$4,941
	30	72	29 1/4	116	44	DY1-TDR-1-3072	\$2,688	\$4,300	\$4,673
	30	66	29 1/4	108	41	DY1-TDR-1-3066	\$2,599	\$4,080	\$4,421
	30	60	29 1/4	99	37	DY1-TDR-1-3060	\$2,510	\$3,854	\$4,164
	30	54	29 1/4	91	33	DY1-TDR-1-3054	\$2,457	\$3,670	\$3,948
	24	78	29 1/4	104	39	DY1-TDR-1-2478	\$2,552	\$3,948	\$4,274
	24	72	29 1/4	98	36	DY1-TDR-1-2472	\$2,468	\$3,759	\$4,059
	24	66	29 1/4	91	33	DY1-TDR-1-2466	\$2,405	\$3,586	\$3,859
	24	60	29 1/4	84	30	DY1-TDR-1-2460	\$2,342	\$3,418	\$3,665
	24	54	29 1/4	78	27	DY1-TDR-1-2454	\$2,279	\$3,245	\$3,471
	24	48	29 1/4	71	24	DY1-TDR-1-2448	\$2,216	\$3,077	\$3,276

- shaped all sides
- wire chase clips on all legs
- wire extrusion channel included
- leveling glides
- non-locking casters available on front legs, specify when ordering; no upcharge
- non-locking casters available on all four legs, specify when ordering; no upcharge
- grommet available, specify and add \$79 list each; see page 217
- NOTE: casters, grommets or privacy screen not available on glass tops

Description	D	W	H	CTN WT	CU FT	① Model	Wood	Clear Glass	Back Painted Glass
Bow Table Desk 	36	78	29 ¼	140	57	DY1-TDB-1-3678	\$3,098	\$5,198	\$5,681
	36	72	29 ¼	129	52	DY1-TDB-1-3672	\$2,982	\$4,920	\$5,366

- shaped all sides
- wire chase clips on all legs
- wire extrusion channel included
- leveling glides
- non-locking casters available on front legs, specify when ordering; no upcharge
- non-locking casters available on all four legs, specify when ordering; no upcharge
- grommet available, specify and add \$79 list each; see page 217
- NOTE: casters, grommets or privacy screen not available on glass tops

Round Table Desk 	60	60	29 ¼	169	72	DY8-MTL-1-0060	\$2,751	\$4,851	\$5,334
	54	54	29 ¼	141	59	DY8-MTL-1-0054	\$2,625	\$4,368	\$4,773
	48	48	29 ¼	118	47	DY8-MTL-1-0048	\$2,499	\$3,843	\$4,153

- wire chase clips on all legs
- wire extrusion channel included
- leveling glides
- non-locking casters available on all four legs, specify when ordering; no upcharge
- NOTE: casters not available on glass tops

To Order, Specify:

- ① Model Number
- ② Wood Species on Top - Cherry (CH1), Maple (MA1), Walnut (WA1) or Double Cut (DC1) (see page 215)
- ③ Finish Color for Top (see page 215)
- ④ Leg Color (see page 216)

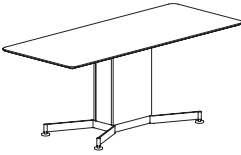
Description	D	W	H	CTN WT	CU FT	① Model	List Price
Fixed Height Table Desk 	36	72	29 ¼	179	52	DY1-TDR-CS-3672	\$3,917
	34	60	29 ¼	159	42	DY1-TDR-CS-3460	\$3,654
	34	54	29 ¼	148	38	DY1-TDR-CS-3454	\$3,602

- shaped all sides
- removable access panel
- leveling glides
- grommet available, specify and add \$79 list each; see page 217

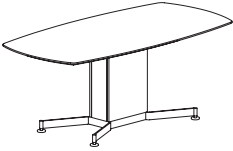
Bow Fixed Height Table Desk 	36	72	29 ¼	179	52	DY1-TDB-CS-3672	\$4,127
--	----	----	------	-----	----	------------------------	----------------

- shaped all sides
- removable access panel
- leveling glides
- grommet available, specify and add \$79 list each; see page 217

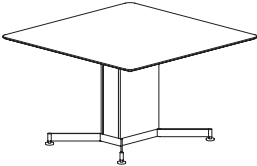
Square Fixed Height Meeting Table 	60	60	29 ¼	298	72	DY8-MTL-CS-6060	\$3,864
	54	54	29 ¼	274	59	DY8-MTL-CS-5454	\$3,738
	48	48	29 ¼	253	47	DY8-MTL-CS-4848	\$3,612

- shaped all sides
- removable access panel
- leveling glides

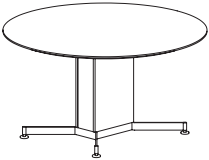
Round Fixed Height Meeting Table 	60	60	29 ¼	293	72	DY8-MTL-CS-0060	\$3,896
	54	54	29 ¼	269	59	DY8-MTL-CS-0054	\$3,770
	48	48	29 ¼	248	47	DY8-MTL-CS-0048	\$3,644

- removable access panel
- leveling glides

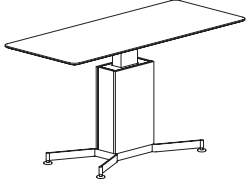
Description	D	W	H	CTN WT	CU FT	① Model	List Price
Adjustable Height Table Desk 	36	72	Adj.	219	53	DY1-TDR-AP-3672	\$5,770
	34	60	Adj.	199	42	DY1-TDR-AP-3460	\$5,508
	34	54	Adj.	188	38	DY1-TDR-AP-3454	\$5,455

- shaped all sides
- removable access panel
- leveling glides
- motorized adjustable height
- 29 ¾"-42 ¼" height adjustment
- grommet available, specify and add \$79 list each; see page 217

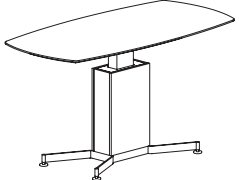
Bow Adjustable Height Table Desk 	36	72	Adj.	219	53	DY1-TDB-AP-3672	\$5,980
--	----	----	------	-----	----	------------------------	----------------

- shaped all sides
- removable access panel
- leveling glides
- motorized adjustable height
- 29 ¾"-42 ¼" height adjustment
- grommet available, specify and add \$79 list each; see page 217

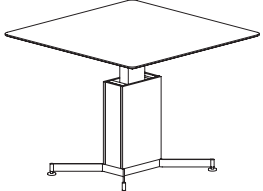
Square Adjustable Height Meeting Table 	60	60	Adj.	329	73	DY8-MTL-AP-6060	\$5,718
	54	54	Adj.	304	59	DY8-MTL-AP-5454	\$5,592
	48	48	Adj.	283	47	DY8-MTL-AP-4848	\$5,466

- shaped all sides
- removable access panel
- leveling glides
- motorized adjustable height
- 29 ¾"-42 ¼" height adjustment

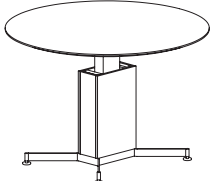
Round Adjustable Height Meeting Table 	60	60	Adj.	324	73	DY8-MTL-AP-0060	\$5,749
	54	54	Adj.	299	59	DY8-MTL-AP-0054	\$5,623
	48	48	Adj.	278	47	DY8-MTL-AP-0048	\$5,497

- removable access panel
- leveling glides
- motorized adjustable height
- 29 ¾"-42 ¼" height adjustment

To Order, Specify:

- ① Model Number
- ② Wood Species on Top - Cherry (CH1), Maple (MA1), Walnut (WA1) or Double Cut (DC1) (see page 215)
- ③ Finish Color for Top (see page 215)
- ④ Color for Chassis (see page 215)
 - A. Same as Top
 - B. Paint Color (see page 215)
- ⑤ Leg Color (see page 216)

Description	D	W	H	CTN WT	CU FT	① Model	List Price
69" h Hinged Door Unit	15	36	69	350	27	DY6-HHT-1-1536	\$3,255
	15	30	69	292	23	DY6-HHT-1-1530	\$3,045

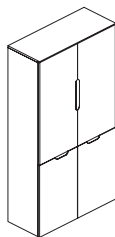

- recessed pulls standard, optional prism pulls available; specify when ordering
- two adjustable shelves in top hinged door compartment
- one adjustable shelf in bottom hinged door compartment
- locking doors available, specify and add \$210 list
- adjustable levelers/glides
- must be mounted to wall or adjacent hinged door unit

69" h Hinged Door Unit with Open Top Compartment	15	36	69	199	27	DY6-OHT-1-1536	\$2,846
	15	30	69	166	23	DY6-OHT-1-1530	\$2,678

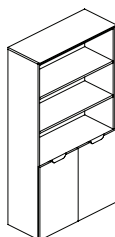

- top compartment open from front
- recessed pulls standard, optional prism pulls available; specify when ordering
- two adjustable shelves in top compartment
- one adjustable shelf in hinged door compartment
- locking doors available, specify and add \$105 list
- adjustable levelers/glides

69" h Hinged Door Unit with Pass-Through Top Compartment	15	36	69	170	27	DY6-BHT-1-1536	\$2,720
	15	30	69	142	23	DY6-BHT-1-1530	\$2,562

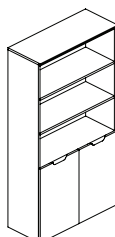

- top compartment open both sides
- recessed pulls standard, optional prism pulls available; specify when ordering
- two fixed shelves in top compartment
- one adjustable shelf in hinged door compartment
- locking doors available, specify and add \$105 list
- adjustable levelers/glides

Description	D	W	H	CTN WT	CU FT	① Model	List Price
56" h Hinged Door Unit	15	36	56	284	22	DY6-HHS-1-1536	\$2,982
	15	30	56	237	19	DY6-HHS-1-1530	\$2,804

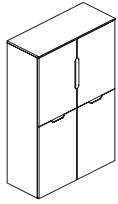

- recessed pulls standard, optional prism pulls available; specify when ordering
- one adjustable shelf in top hinged door compartment
- one adjustable shelf in bottom hinged door compartment
- locking doors available, specify and add \$210 list
- adjustable levelers/glides

56" h Hinged Door Unit with Open Top Compartment	15	36	56	197	22	DY6-OHS-1-1536	\$2,982
	15	30	56	164	19	DY6-OHS-1-1530	\$2,641

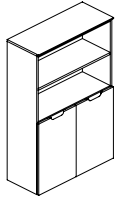

- top compartment open from front
- recessed pulls standard, optional prism pulls available; specify when ordering
- one adjustable shelf in top compartment
- one adjustable shelf in hinged door compartment
- locking doors available, specify and add \$105 list
- adjustable levelers/glides

56" h Hinged Door Unit with Pass-Through Top Compartment	15	36	56	216	22	DY6-BHS-1-1536	\$2,720
	15	30	56	202	19	DY6-BHS-1-1530	\$2,568

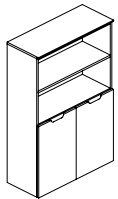

- top compartment open both sides
- recessed pulls standard, optional prism pulls available; specify when ordering
- one fixed shelf in top compartment
- one adjustable shelf in hinged door compartment
- locking doors available, specify and add \$105 list
- adjustable levelers/glides

To Order, Specify:

- ① Model Number
- ② Wood Species on Top/Chassis - Cherry (CH1), Maple (MA1), Walnut (WA1) or Double Cut (DC1) (see page 215)
- ③ Finish Color for Top/Chassis (see page 215)
- ④ Finish Color for Door/Drawer Fronts (see page 215)
 - A. Same as Top/Chassis
 - B. Paint Color (see page 215)
- ⑤ Pull Color (see page 216)

Description	D	W	H	CTN WT	CU FT	① Model	List Price
Hinged Door with Open Compartment	15	36	43	150	17	DY6-OHL-1-1536	\$2,515
	15	30	43	125	14	DY6-OHL-1-1530	\$2,363

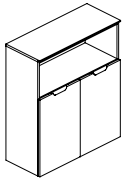

- top compartment open from front
- recessed pulls standard, optional prism pulls available; specify when ordering
- adjustable shelf
- locking doors available, specify and add \$105 list
- adjustable levelers/glides

Hinged Door with Pass-Through Top Compartment	15	36	43	166	17	DY6-BHL-1-1536	\$2,468
	15	30	43	155	14	DY6-BHL-1-1530	\$2,321

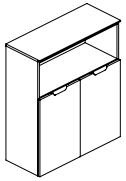

- top compartment open both sides
- recessed pulls standard, optional prism pulls available; specify when ordering
- adjustable shelf
- locking doors available, specify and add \$105 list
- adjustable levelers/glides

Description	D	W	H	CTN WT	CU FT	① Model	List Price
Open Bookcase	15	72	26	255	21	DY6-OBK-1S-1572	\$2,310
	15	60	26	225	18	DY6-OBK-1S-1560	\$2,258

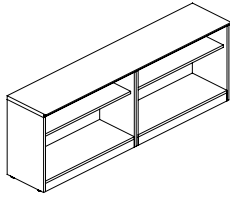

- adjustable shelf
- adjustable levelers/glides

Sliding Door Bookcase	15	72	26	258	21	DY6-OBK-SS-1572	\$2,699
	15	60	26	227	18	DY6-OBK-SS-1560	\$2,625

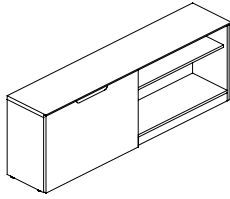

- single sliding door
- adjustable shelf
- recessed pulls standard, optional prism pulls available; specify when ordering
- adjustable levelers/glides

To Order, Specify:

- ① Model Number
- ② Wood Species on Top/Chassis - Cherry (CH1), Maple (MA1), Walnut (WA1) or Double Cut (DC1) (see page 215)
- ③ Finish Color for Top/Chassis (see page 215)
- ④ Finish Color for Door/Drawer Fronts (see page 215)
 - A. Same as Top/Chassis
 - B. Paint Color (see page 215)
- ⑤ Pull Color (see page 216)

Shuffle Conference Product Information



Shuffle Conference Product Information

Exterior Wood Materials

Exterior surfaces are made from the finest selected veneers to achieve clarity and consistency in the Shuffle product line. To attain a pleasing, symmetrical pattern, all veneers in Shuffle are book-matched. All exterior solid lumber is matched to coordinate with the veneer.

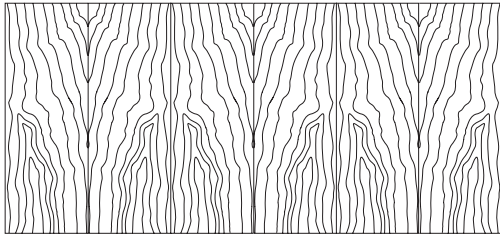

Book Matched Example

Alternating pieces of veneer are flipped over so they face each other like the pages within a book.

Shuffle is available in flat cut cherry veneer. A wide range of wood stains have been formulated to enhance the beauty of the veneer.

Work Surface Construction

Tops are 5-ply balanced construction, 1 3/16" thick with solid matching hardwood edges. Tops are available in six edge profile.

Matching or coordinating high pressure laminate in a veneer grain can be applied to the top surface and is available at no additional charge.

Base Construction

Panels are joined together by mortise and tenon construction. In addition to mortise and tenon joint construction. Leveling glides are set into solid hardwood with t-nut inserts, which helps to prevent the leveling glide from tear out. Tops are secured to the bases with top fastening cleats screwed to the inside of the panels.

Drawers

The 9ply unidirectional hardwood sides of the drawer box are 7/16" thick assembled with English dovetail construction at each corner of the box. The drawer bottom panel is 1/4" thick fitting into a groove machined into the side of the box. Interiors are sanded and coated with clear U.V. finish to protect against shrinking, swelling or warping, and to provide a clean, smooth feel and appearance.

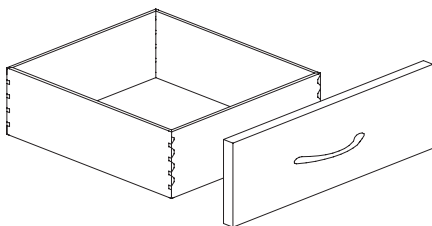

Drawer Suspension

The high quality black drawer suspensions carry a lifetime warranty. Slides feature steel ball bearings for longer life with cushioned in/out stops. File and box drawers have 100% full extension with over travel.

Finish - Stain/Colors

We offer a variety of wood stains and paint colors on Shuffle. Please see the chart below. Samples are available upon request. Former finish names are listed in parentheses for reference.

CH1 Cherry		<i>Flat Cut Veneer</i>	
AUT	Autumn (<i>Autumn Cherry</i>)	EAR	Earthy
BRL	Barley	LGC	Legacy (<i>Legacy Cherry</i>)
BBN	Bourbon (<i>Natural Cherry</i>)	PRL	Praline (<i>Vintage Cherry</i>)
BRG	Brighton (<i>Brighton Cherry</i>)	SAF	Saffron (<i>Medium Cherry</i>)
CLA	Classic (<i>Classic Cherry</i>)		

Protective Top Coat

DuraTex™ offers exceptional hardness along with abrasion and impact resistance, it has been formulated to eliminate hazardous and harmful gases that are normally associated with wood finish.

DuraTex™ Features

Safety - Significantly reduces hazardous formaldehyde emissions, which help improve the quality of the indoor air we breathe.

Quality - Developed to be tough and durable with special attention to appearance. The DuraTex™ finish preserves the natural beauty of wood.

Durability - Designed to meet a wide range of demanding performance and environmental standards to withstand even the highest wear and tear.

Shuffle Conference Product Information

Product Modification

Laminate Tops

Worksurface only, no additional upcharge if coordinating wood grain laminate is specified. Contact Customer Service for any other laminate request. Listed below are finishes that have coordinating wood grain HPL laminates.

Cherry Finishes

Autumn

Barley

Bourbon

Brighton

Classic

Legacy

Praline

Saffron

Special Finishes

Special finishes can be requested by following the instruction in the general introduction section, page 3. There is a one time charge of \$289 list per order.

Finish Sheen Modification

Finish sheen can be modified on the worksurface tops. There is a 15% upcharge added to the list of each item.

Oak Veneer

Upon request veneer can be changed from the standard offering to oak flat cut veneer with an additional 40% upcharge to the list of each item.

Shuffle Conference Product Information

Top Edge Details

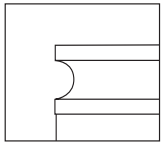

Concave (O)

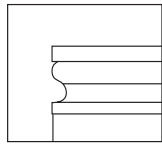

Crown (Q)

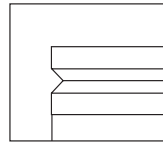

Diamond (T)

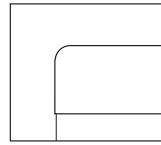

Eased (R)

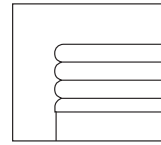

Reeded (H)

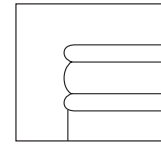

Transitional (C)

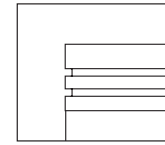

Triad (F)

Drawer Style Color Options

Finish Color MBK = Matte Black MNK = Matte Nickel PNK = Polished Nickel CHR = Chrome



 Bask
(PNK)

 Fluent
(MBK or MNK)

 Rival
(CHR)

 Slotted
(MBK or MNK)

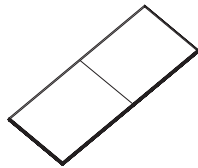
Top Shapes - size - base requirement - seating capacity

top sizes 108" through 192" are 2 pieces
top sizes above 192" are 3 pieces

rectangular

264" x 60"	4 bases	seats 24
240" x 60"	4 bases	seats 22
216" x 60"	4 bases	seats 20
192" x 60"	3 bases	seats 18
264" x 54"	4 bases	seats 22
240" x 54"	4 bases	seats 20
216" x 54"	4 bases	seats 18
192" x 54"	3 bases	seats 16
264" x 48"	4 bases	seats 22
240" x 48"	4 bases	seats 20
216" x 48"	4 bases	seats 18
192" x 48"	3 bases	seats 16
168" x 48"	3 bases	seats 14
144" x 48"	3 bases	seats 12
120" x 48"	2 bases	seats 8
120" x 42"	2 bases	seats 8
108" x 42"	2 bases	seats 8
96" x 48"	2 bases	seats 8
96" x 42"	2 bases	seats 8
84" x 42"	2 bases	seats 8
72" x 36"	2 bases	seats 6



racetrack

264" x 60"	4 bases	seats 24
240" x 60"	4 bases	seats 22
216" x 60"	4 bases	seats 20
192" x 60"	3 bases	seats 18
264" x 54"	4 bases	seats 22
240" x 54"	4 bases	seats 20
216" x 54"	4 bases	seats 18
192" x 54"	3 bases	seats 16
264" x 48"	4 bases	seats 22
240" x 48"	4 bases	seats 20
216" x 48"	4 bases	seats 18
192" x 48"	3 bases	seats 16
168" x 48"	3 bases	seats 14
144" x 48"	3 bases	seats 12
120" x 48"	2 bases	seats 8
120" x 42"	2 bases	seats 8
108" x 42"	2 bases	seats 8
96" x 48"	2 bases	seats 8
96" x 42"	2 bases	seats 8
84" x 42"	2 bases	seats 8
72" x 36"	2 bases	seats 6

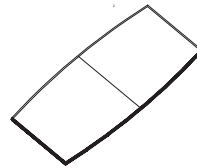

boat

264" x 60"	4 bases	seats 24
240" x 60"	4 bases	seats 22
216" x 60"	4 bases	seats 20
192" x 60"	3 bases	seats 18
264" x 54"	4 bases	seats 22
240" x 54"	4 bases	seats 20
216" x 54"	4 bases	seats 18
192" x 54"	3 bases	seats 16
264" x 48"	4 bases	seats 22
240" x 48"	4 bases	seats 20
216" x 48"	4 bases	seats 18
192" x 48"	3 bases	seats 16
168" x 48"	3 bases	seats 14
144" x 48"	3 bases	seats 12
120" x 48"	2 bases	seats 8
120" x 42"	2 bases	seats 8
108" x 42"	2 bases	seats 8
96" x 48"	2 bases	seats 8
96" x 42"	2 bases	seats 8
84" x 42"	2 bases	seats 8
72" x 36"	2 bases	seats 6



round*

60" dia.	Seats 6
54" dia.	Seats 6
48" dia.	Seats 4
42" dia.	Seats 4
36" dia.	Seats 4

*requires 1 base

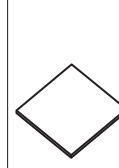

square*

60" sq.	seats 8
54" sq.	seats 6
48" sq.	seats 4
42" sq.	seats 4
36" sq.	seats 4
30" sq.	seats 4

*requires 1 base

Base (units with access panel in the base for wire management are available, order this feature with the appropriate model number.)

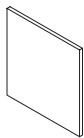
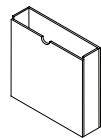
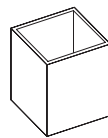
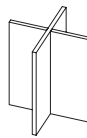
 panel base
30" and 24" width

 rectangle base
30" and 24" width

 square base
24" and 18" width

 cross base
24" and 18" width

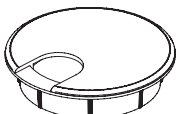
 round base
24", 20" and 18" dia.

 half-round base
24", 20 and 18" dia.

Grommet



Shuffle Grommets

Work surface grommets can be specified on desks, credenzas, and other types of veneer/laminate work surfaces. The grommet location must be approved by JSI manufacturing; contact Customer Service.

Add \$79 to the list for each grommet.

Grommet color must be specified, select Matte Black or Stardust Silver. Lock cores will match grommet color.

Matte Black (MBK)
Stardust Silver (STS).

Shuffle Conference Product Information

Finish and Product Reference Codes

Select	Code
--------	------

Veneer

Cherry Flat Cut	CH1
-----------------	-----

Finish

Cherry Finishes

Autumn	AUT
Barley	BRL
Bourbon	BBN
Brighton	BRG
Classic	CLA
Earthy	EAR
Legacy	LGC
Praline	PRL
Saffron	SAF

Select	Code
--------	------

Edge Details

Concave	O
Crown	Q
Diamond	T
Eased	R
Reeded	H
Transitional	C
Triad	F

Pull & Finishes Codes

Bask - Polished Nickel	PNK
Fluent - Matte Black	MBK
Fluent - Mattle Nickel	MNK
Rival - Chrome	CHR
Slotted - Matte Black	MBK
Slotted - Matte Nickel	

Select	Code
--------	------

Laminate Coordinates

Cherry Wood Grain Patterns

Autumn	AUT
Barley	BRL
Bourbon	BBN
Brighton	BRG
Classic	CLA
Legacy	LGC
Praline	PRL
Saffron	SAF

Metal Finish *(grommet)*

Matte Black	MBK
Stardust Silver	STS

Order Check List:

Specify:

- 1. Model Number
- 2. Finish
- 3. Wood Species - cherry
- 4. Top Options - standard veneer - laminate surface (see page 233)
- 5. Pull Selection **if applicable**
- 6. Other Product Options
- 7. Power and Data Accessories (*drawing showing location and orientation must accompany order*)
- 8. Side Mark Information (*i.e. room number, East Conference Room*)
- 9. Shipping Address (*contact name and phone number*)
- 10. Special Delivery Instructions (*i.e. call before delivery, deliver to job site*)

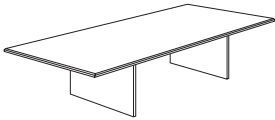
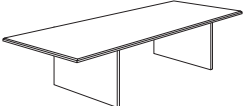
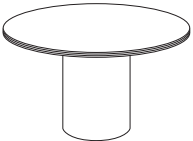
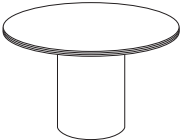
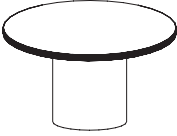
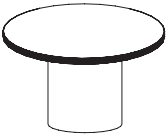
Description	D	W	H	Seating Capacity	CTN WT	CU FT	① Model	List Price
Conference Table	42	96	30	8			SH4296CTP	\$3,958
					172	15	Consists of:	
					54 ea.	4 ea.	SH4296TT - Table Top	\$2,908
							SH2428PB - Panel Bases	\$1,050
							<ul style="list-style-type: none"> ships KD in four cartons one piece top price reflects two bases price includes one SH0655SP stretcher panel must order (2) panel bases 	
Rectangular Conference Table	36	72	30	6			SH3672CTP	\$2,919
					110	10	Consists of:	
					54 ea.	4 ea.	SH3672TT - Table Top	\$1,869
							SH2428PB - Panel Bases	\$1,050
							<ul style="list-style-type: none"> ships KD in four cartons one piece top 	
Round Conference Table	48	48	30	4			SH48CTD	\$2,259
					73	7	Consists of:	
					71	9	SH48TT - Table Top	\$1,455
							SH20RB - Round Base	\$804
							<ul style="list-style-type: none"> ships KD in two cartons 	
Round Conference Table	42	42	30	4			SH42CTD	\$1,915
					56	5	Consists of:	
					71	9	SH42TT - Table Top	\$1,111
							SH20RB - Round Base	\$804
							<ul style="list-style-type: none"> ships KD in two cartons 	
Lounge Height Meeting Table	42	42	16				SH42MTD	\$1,863
					56	5	Consists of:	
					68	5	SH42TT - Table Top	\$1,111
							SH18-16RB - Round Base	\$752
							<ul style="list-style-type: none"> ships KD in two cartons 	
Lounge Height Meeting Table	36	36	16				SH36MTD	\$1,730
					42	4	Consists of:	
					68	5	SH36TT - Table Top	\$978
							SH18-16RB - Round Base	\$752
							<ul style="list-style-type: none"> ships KD in two cartons 	

To Order, Specify:

- ① Model Number
- ② Wood Species
- ③ Finish Color
 - A. Worksurface Finish
 - B. Chassis Finish
- ④ Edge Profile
- ⑤ Power and Data Options (see page 322)
- ⑥ Other Product Options

Description	① Model	W	L	Seat Capacity	Top Pieces	Bases Required	CTN WT	CU FT	List Price
Rectangular Tops 	SH60264TT	60	264	24	3	4	673	57	\$12,280
	SH60240TT	60	240	22	3	4	613	51	\$11,163
	SH60216TT	60	216	20	3	4	552	48	\$10,050
	SH60192TT	60	192	18	2	3	490	42	\$8,931
	SH54264TT	54	264	22	3	4	609	52	\$10,234
	SH54240TT	54	240	20	3	4	554	50	\$9,303
	SH54216TT	54	216	18	3	4	498	43	\$8,375
	SH54192TT	54	192	16	2	3	441	38	\$7,443
	SH48264TT	48	264	22	3	4	548	47	\$9,099
	SH48240TT	48	240	20	3	4	498	43	\$8,272
	SH48216TT	48	216	18	3	4	447	38	\$7,443
	SH48192TT	48	192	16	2	3	396	33	\$6,618
	SH48168TT	48	168	14	2	3	346	30	\$5,791
	SH48144TT	48	144	12	2	3	296	28	\$4,964
	SH48120TT**	48	120	8	2	2	245	22	\$4,137
	SH4896TT	48	96	8	1	2	197	17	\$3,324
	SH42120TT**	42	120	8	2	2	217	19	\$3,620
	SH42108TT	42	108	8	2	2	195	17	\$3,260
	SH4296TT	42	96	8	1	2	172	15	\$2,908
	SH4284TT	42	84	8	1	2	151	13	\$2,531
SH3672TT	36	72	6	1	2	110	10	\$1,869	

**When ordering RECTANGLE or PANEL BASES - SH48120 and SH42120 require (3) panel bases and additional stretchers. Stretchers will be included as required.

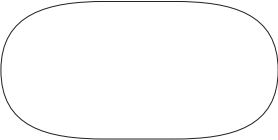
Description	① Model	W	L	Seat Capacity	Top Pieces	Bases Required	CTN WT	CU FT	List Price
Racetrack Tops 	SH60264RT	60	264	24	3	4	646	57	\$14,511
	SH60240RT	60	240	22	3	4	589	51	\$13,193
	SH60216RT	60	216	20	3	4	530	48	\$11,875
	SH60192RT	60	192	18	2	3	471	42	\$10,556
	SH54264RT	54	264	22	3	4	586	52	\$12,093
	SH54240RT	54	240	20	3	4	530	50	\$10,994
	SH54216RT	54	216	18	3	4	474	43	\$9,896
	SH54192RT	54	192	16	2	3	417	38	\$8,796
	SH48264RT	48	264	22	3	4	529	47	\$10,750
	SH48240RT	48	240	20	3	4	479	43	\$9,774
	SH48216RT	48	216	18	3	4	428	38	\$8,796
	SH48192RT	48	192	16	2	3	377	33	\$7,819
	SH48168RT	48	168	14	2	3	327	30	\$6,760
	SH48144RT	48	144	12	2	3	277	28	\$5,866
	SH48120RT**	48	120	8	2	2	226	22	\$4,891
	SH4896RT	48	96	8	1	2	185	17	\$3,912
	SH42120RT**	42	120	8	2	2	203	19	\$4,277
	SH42108RT	42	108	8	2	2	180	17	\$3,851
	SH4296RT	42	96	8	1	2	157	15	\$3,422
	SH4284RT	42	84	8	1	2	142	13	\$3,007
SH3672RT	36	72	6	1	2	100	10	\$2,204	

**When ordering RECTANGLE or PANEL BASES - SH48120 and SH42120 require (3) panel bases and additional stretchers. Stretchers will be included as required.

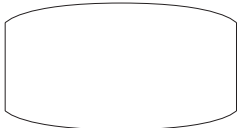

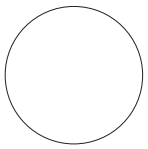
Description	① Model	W	L	Seat Capacity	Top Pieces	Bases Required	CTN WT	CU FT	List Price
Boat Shape Tops  • boat shape top end dimension is 6" less than center dimension **When ordering RECTANGLE or PANEL BASES - SH48120 and SH42120 require (3) panel bases and additional stretchers. Stretchers will be included as required.	SH60264BT	60	264	24	3	4	646	57	\$14,511
	SH60240BT	60	240	22	3	4	589	51	\$13,193
	SH60216BT	60	216	20	3	4	530	48	\$11,875
	SH60192BT	60	192	18	2	3	471	42	\$10,556
	SH54264BT	54	264	22	3	4	586	52	\$12,093
	SH54240BT	54	240	20	3	4	530	50	\$10,994
	SH54216BT	54	216	18	3	4	474	43	\$9,896
	SH54192BT	54	192	16	2	3	417	38	\$8,796
	SH48264BT	48	264	22	3	4	529	47	\$10,750
	SH48240BT	48	240	20	3	4	479	43	\$9,774
	SH48216BT	48	216	18	3	4	428	38	\$8,796
	SH48192BT	48	192	16	2	3	377	33	\$7,819
	SH48168BT	48	168	14	2	3	327	30	\$6,760
	SH48144BT	48	144	12	2	3	277	28	\$5,866
	SH48120BT**	48	120	8	2	2	226	22	\$4,891
	SH4896BT	48	96	8	1	2	185	17	\$3,912
	SH42120BT**	42	120	8	2	2	203	19	\$4,277
	SH42108BT	42	108	8	2	2	180	17	\$3,851
	SH4296BT	42	96	8	1	2	157	15	\$3,422
	SH4284BT	42	84	8	1	2	142	13	\$3,007
SH3672BT	36	72	6	1	2	100	10	\$2,204	





Round Tops	Model	W	L	Seat Capacity	Top Pieces	Bases Required	CTN WT	CU FT	List Price
	SH60TT	60	N/A	6	1	1	112	10	\$2,461
	SH54TT	54	N/A	6	1	1	92	8	\$1,847
	SH48TT	48	N/A	4	1	1	73	7	\$1,455
	SH42TT	42	N/A	4	1	1	56	5	\$1,111
	SH36TT	36	N/A	3	1	1	42	4	\$978
	SH30TT	30	N/A	3	1	1	30	3	\$863

Square Tops	Model	W	L	Seat Capacity	Top Pieces	Bases Required	CTN WT	CU FT	List Price
	SH6060TT	60	60	8	1	1	154	10	\$2,254
	SH5454TT	54	54	6	1	1	125	8	\$1,706
	SH4848TT	48	48	4	1	1	99	7	\$1,347
	SH4242TT	42	42	4	1	1	77	5	\$1,032
	SH3636TT	36	36	4	1	1	56	4	\$931
	SH3030TT	30	30	4	1	1	39	3	\$647

To Order, Specify:

- ① Model Number
- ② Wood Species
- ③ Finish Color
 - A Worksurface Finish
 - B. Chassis Finish
- ④ Edge Profile
- ⑤ Power and Data Options (see page 322)
- ⑥ Other Product Options

Description	D	W	H	CTN WT	CU FT	① Model	List Price
Half Round Base 	12	24	28 ¾	35	6	SH24HRB · for use with 54" width top	\$691
	12	24	28 ¾	33	6	SH24HRBA	\$813
	10	20	28 ¾	30	5	SH20HRB · for use with 42" and 48" width top	\$630
	10	20	28 ¾	28	5	SH20HRBA	\$754
	9	18	28 ¾	27	4	SH18HRB · for use with 36" width top	\$604
	9	18	28 ¾	26	4	SH18HRBA	\$730
Square Base 	30	30	28 ¾	68	16	SH30SB	\$865
	30	30	28 ¾	68	16	SH30SBA	\$973
	24	24	28 ¾	68	12	SH24SB · for use with 54" and 60" width top	\$763
	24	24	28 ¾	68	12	SH24SBA · for use with 54" and 60" width top · access panel	\$871
	18	18	28 ¾	39	7	SH18SB · for use with 36", 42" and 48" width top	\$658
	18	18	28 ¾	39	7	SH18SBA · for use with 36", 42" and 48" width top · access panel	\$766
Cross Base 	30	30	28 ¾	80	16	SH30XB	\$716
	24	24	28 ¾	80	12	SH24XB · for use with 48", 54" and 60" width top	\$644
	18	18	28 ¾	50	7	SH18XB · for use with 36" and 42" width top	\$575

Description	D	W	H	CTN WT	CU FT	① Model	List Price
Panel Base 	2 5/16	36	28 3/4	83	6	SH3628PB	\$632
	2 5/16	30	28 3/4	68	5	SH3028PB · for use with 54" width top	\$580
	2 5/16	24	28 3/4	54	4	SH2428PB · for use with 42" and 48" width top · (3) bases are required when ordering SH48120 or SH42120	\$525
Rectangle Base   side 1 side 2	7 5/16	36	28 3/4	69	7	SH3628PBA	\$1,067
	7 5/16	30	28 3/4	60	6	SH3028PBA · for use with 54" width top · access panel	\$1,015
	7 5/16	24	28 3/4	52	5	SH2428PBA · for use with 42" and 48" width top · access panel	\$958
Round Base 	24	N/A	28 3/4	74	12	SH24RB · for use with 54" and 60" width top	\$915
	24	N/A	28 3/4	37	12	SH24RBA · for use with 54" and 60" width top · access panel	\$1,022
	20	N/A	28 3/4	71	9	SH20RB · for use with 42" and 48" width top	\$804
	20	N/A	28 3/4	34	9	SH20RBA · for use with 42" and 48" width top · access panel	\$912
	18	N/A	28 3/4	68	7	SH18RB · for use with 36" width top	\$752
	18	N/A	28 3/4	31	7	SH18RBA · for use with 36" width top · access panel	\$860

To Order, Specify:

- ① Model Number
- ② Wood Species
- ③ Finish Color
 - A. Worksurface Finish
 - B. Chassis Finish
- ④ Power and Data Options (see page 322)
- ⑤ Other Product Options

Description	D	W	H	CTN WT	CU FT	① Model	List Price
Conference Lectern	25 1/4	25 3/8	48	250	23	SH2622LEC	\$2,677

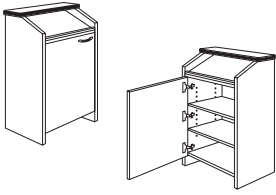

- two adjustable shelves
- four concealed, locking casters
- door is non-locking
- standard door is hinged on left
- round grommet in bottom panel
- notches in adjustable shelves allow wires to pass through

Visual Board	3 3/4	47 3/8	48	125	8	SH4848VB	\$3,208
---------------------	-------	--------	----	-----	---	-----------------	----------------

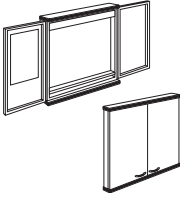

- corkboard on right and left doors; paper pad on left only
- marker board in center
- four markers and eraser included
- locking not available

Buffet Credenza	24	72	36	320	43	SH2472BSC	\$5,134
------------------------	----	----	----	-----	----	------------------	----------------

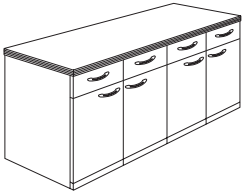

- non-modular assembled unit
- four door credenza
- four box drawers above doors
- non-locking doors and drawers
- adjustable shelf in storage cabinet

Buffet Credenza - Flat Screen Support	24	72	36	320	43	SH2472BSCT	\$5,506
--	----	----	----	-----	----	-------------------	----------------

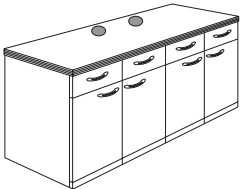

- non-modular assembled unit
- four door credenza
- four box drawers above doors
- non-locking doors and drawers
- adjustable shelf in storage cabinet
- flat screen mounting grommets in top
- back panel includes cord exit grommets

Flat Screen Mounting Frame	2	14	55	35	4	FSTV	\$1,236
-----------------------------------	---	----	----	----	---	-------------	----------------

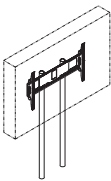

- round 2" tube frame with cable management to inside of credenza
- mounting bracket for TV provided (see page 322)
- available in black (B) or silver (S)
- TV not included
- coordinates with SH2472BSCT

Description	D	W	H	CTN WT	CU FT	① Model	List Price
72" h File/File Lateral Storage Cabinet	24	34 7/8	71 11/16	360	43	SH3672SWLF	\$3,748

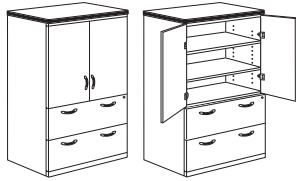

- two adjustable shelves
- locking doors available; specify and add \$105 list
- file/file lateral
- pedestal locking

72" h Wardrobe	23 3/4	34 7/8	71 11/16	360	43	SH3672W	\$3,323
-----------------------	--------	--------	----------	-----	----	----------------	----------------

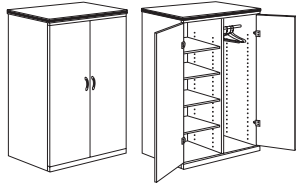

- chrome hanging bar on right
- one fixed shelf second from bottom on left
- locking doors available; specify and add \$210 list

Hanging Bar to Shelves Conversion Kit	24	18	3/4	56	2	SH1824SK	\$634
--	----	----	-----	----	---	-----------------	--------------

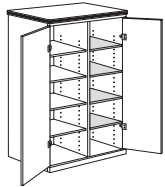

- four shelves
- for 36" wide wardrobe

72" h File/File Storage Wardrobe	23 3/4	23 5/8	71 11/16	340	30	SH2472SWR	\$3,420
	23 3/4	23 5/8	71 11/16	340	30	SH2472SWL	\$3,420

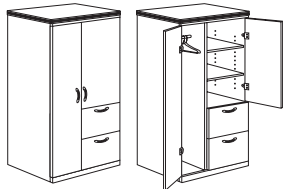

- top edge profile on user side
- chrome hanging bar
- two adjustable shelves
- file/file pedestal
- locking not available

To Order, Specify:

- ① Model Number
- ② Wood Species
- ③ Finish Color
 - A Worksurface Finish
 - B. Chassis Finish
- ④ Edge Profile
- ⑤ Pull (style and color)
- ⑥ Power and Data Options (see page 322)
- ⑦ Other Product Options

Vision Laminate Conference Product Information



VISION - LAMINATE

Vision Laminate Conference Product Information

Laminates

Vision Laminate features TFL (thermally fused laminate) chassis and components. *Worksurfaces* are available in a HPL (high pressure laminate) or in the TFL surface, when indicated by the pricing column

Edges of the worksurface are impact resistant (PVC) on TFL and HPL tops. The laminate is offered in 10 wood grain patterns and 7 solid colors. The wood grain laminate features an embossed grain to hide finger prints and light scratches. The solid laminate is smooth to the touch with a semi-matte finish. All Vision Laminate products are indoor-air certified by GreenGuard.

The chart below lists the laminates available on the Vision product. Former laminate names are listed in parentheses for reference.

TFL - HPL Wood Grain Pattern Laminates

AUT Autumn (<i>Autumn Cherry</i>)	HGL High Line
BLO Blonde Echo	SHE Shea (<i>Nat Maple/Ale finish match</i>)
BBN Bourbon (<i>Natural Cherry</i>)	STU Studio Teak
BZW Brazilwood	WLH Walnut Heights
BRG Brighton (<i>Brighton Cherry</i>)	VIN Vintage (<i>Vintage Cherry</i>)
GRH Graphite	

TFL - HPL Solid Laminates

ALB Alabaster	SHD Shadow
BBL Bridal Blanco	SLG Slate Grey
DWH Designer White	TAU Taupe
DOV Dove Grey	

Select models are available in the **NOW!** quickship program if a veneer grain pattern laminate is selected.

Top Surfaces (*Conference Tops and Credenza Tops*)

Tops have a 3-ply balanced construction. Tops are 1- $\frac{3}{16}$ " thick with coordinating PVC edges.

Conference Tops feature 3mm PVC edges on all sides and are available in HPL only.

Credenza Tops feature 3mm PVC edges on the user side only. Remaining edges are banded with 1mm PVC which allows for a seamless appearance when units are mated end-to-end or back-to-back. Some laminates have a choice of 3 edge profiles, see the next page. Credenza Tops are offered in TFL or HPL.

TFL features on *Conference Top Surfaces**

- fused to the 45 pound density substrate of the top for a durable surface
- tops are laminated on both sides
- available in all the wood grain and solid patterns

HPL features on *Conference Top Surfaces**

- fusion of multiple layers create a higher impact resistant surface
- tops are 3-ply balanced construction
- matched to the TFL wood grain and solid patterns

Case Construction

Panels for chassis consist of a $\frac{3}{4}$ " thick substrate with TFL surfaces and PVC bands on exposed edges. Pedestals and cabinets are constructed with dowels reinforced with screws, cleats and metal fasteners for increased stability. Leveling glides are installed into the panels to prevent tear-outs.

Drawers

The unidirectional V- Fold drawer box is a durable miter-fold drawer structure which is glued and doweled. The $\frac{1}{2}$ " thick drawer sides are wrapped in a high grade maple vinyl, with an attached front. The drawer front is attached to the four sided box.

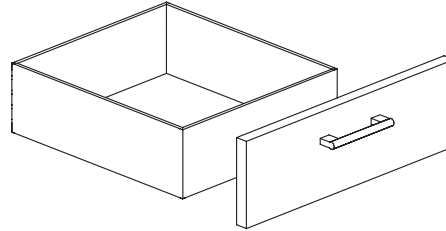

Drawer Suspension

High quality black drawer suspension carries a lifetime warranty. File and box drawers have 100% full extension with over travel. Slides feature steel ball bearings for longer wear and positive, cushioned in/out stops.

Locking

All free standing credenzas, and bench height credenza feature pedestal locking.

Units are shipped randomly keyed as standard. Key alike units are available upon request for no additional charges. Removable cores for in-field re-keying are standard.

Special Construction and Sizes

Vision Laminate offers large offering of top sizes and shapes. Contact Customer Service if you are having trouble with finding the table to complete the desired configuration. Special request may be denied because of material limitations.

Vision Laminate Conference Product Information

Top Edge Details

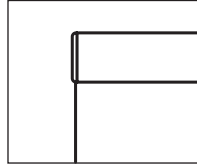

Eased (R3)

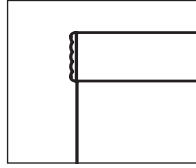

Reeded (H3)

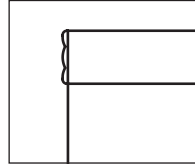

Transitional (C3)

Edge Detail Availability

Laminate	Edges	Laminate	Edges
Autumn (<i>Autumn Cherry</i>)	All	Alabaster	Eased
Blond Echo	Eased	Bridal Blanco	Eased
Bourbon (<i>Natural Cherry</i>)	All	Designer White	Eased
Brazilwood	Eased	Dove Grey	Eased
Brighton (<i>Brighton Cherry</i>)	All	Shadow	Eased
Graphite	Eased	Slate Grey	Eased
High Line	Eased	Taupe	Eased
Shea (<i>Natural Maple</i>)	All		
Studio Teak	Eased		
Vintage (<i>Vintage Cherry</i>)	All		
Walnut Heights	Eased		

Drawer Pull Style and Color Options

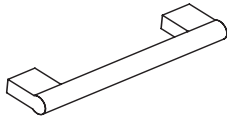

Bar
Matte Black (MBK)
Polished Nickel (PNK)



Fluent
Matte Black (MBK)
Matte Nickel (MNK)

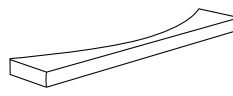

Healy
Matte Nickel (MNK)

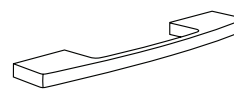

Reveel
Matte Nickel (MNK)



Sweep
Matte Black (MBK)
Matte Nickel (MNK)

Top Shapes - size - base requirement - seating capacity

Note size 120" and above are two piece tops.

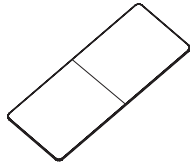

size	base requirement	seating capacity
144" x 48"	3 bases	seats 12
120" x 48"	2 bases	seats 8
96" x 48"	2 bases	seats 8
96" x 42"	2 bases	seats 8
84" x 42"	2 bases	seats 6
72" x 36"	2 bases	seats 6

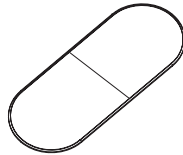

size	base requirement	seating capacity
144" x 48"	3 bases	seats 12
120" x 48"	2 bases	seats 8
96" x 48"	2 bases	seats 8
96" x 42"	2 bases	seats 8
84" x 42"	2 bases	seats 6
72" x 36"	2 bases	seats 6

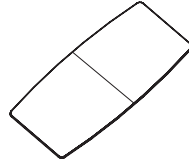

size	base requirement	seating capacity
144" x 48"	3 bases	seats 12
120" x 48"	2 bases	seats 8
96" x 48"	2 bases	seats 8
96" x 42"	2 bases	seats 8
84" x 42"	2 bases	seats 6
72" x 36"	2 bases	seats 6



size	base requirement	seating capacity
60" dia.	requires 1 base	Seats 6
54" dia.	requires 1 base	Seats 6
48" dia.	requires 1 base	Seats 4
42" dia.	requires 1 base	Seats 4
36" dia.	requires 1 base	Seats 4
30" dia.	requires 1 base	Seats 4



size	base requirement	seating capacity
30" x 72"	requires 2 base	
24" x 60"	requires 2 base	

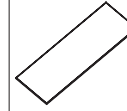

size	base requirement	seating capacity
30" x 72"	requires 2 base	
30" x 66"	requires 2 base	
30" x 60"	requires 2 base	
24" x 72"	requires 2 base	
24" x 66"	requires 2 base	
24" x 60"	requires 2 base	

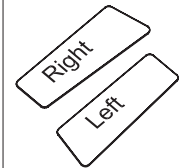

size	base requirement	seating capacity
30" x 96" right	requires 2 base	
24" x 96" right	requires 2 base	
30" x 96" left	requires 2 base	
24" x 80" left	requires 2 base	

Configuration Examples

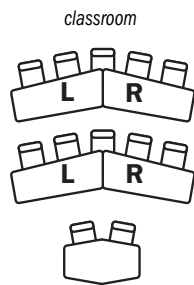

Three configuration using:
1 docking table
2 right wing tables
2 left wing tables

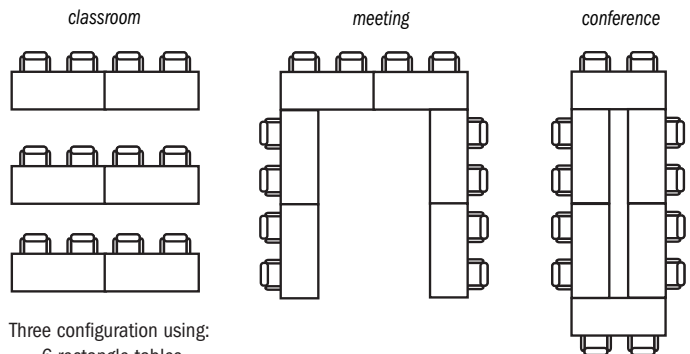
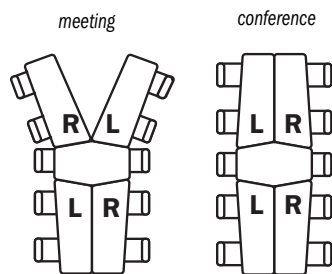

Three configuration using:
6 rectangle tables

Vision Laminate Conference Product Information

Table Base

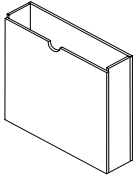

rectangle base 24" width
includes base access panel

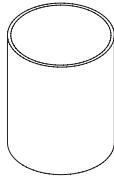

round base
18" dia and 24" dia
includes base access panel



ellipse base
9" x 24"
includes base access panel

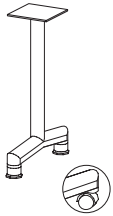

Metal T Base
20" Span
26" Span
• fixed base style
• fixed base with casters*

• tilt base style
• tilt base with casters*
*ship as a set of 2 bases
with cables and lever*

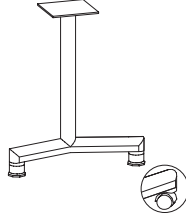

Metal Cantilever T Base
23" Span
• fixed base style
• fixed base with casters*

• tilt base style
• tilt base with casters*
*ship as a set of 2 bases
with cables and lever*

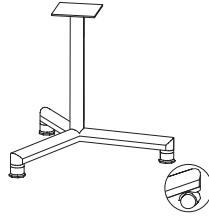

Metal Y Base
34" Span
• fixed base style
• fixed base with casters*

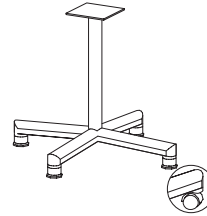

Metal X Base
38" Span
34" Span
26" Span
• fixed base style
• fixed base with casters*

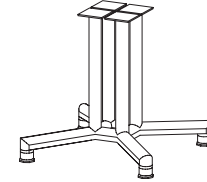

Metal X-4 Base
38" Span
• fixed base style

*casters are locking

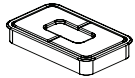

Worksurface Grommet

Additional worksurface grommets can be specified on veneer/laminate worksurfaces. The grommet location must be approved by JSI manufacturing, contact Customer Service. Add \$79 to the list for each additional grommet.

Grommet color must be specified, select Matte Black or Stardust Silver. Lock cores will match grommet color
Matte Black (MBK)
Stardust Silver (STS)

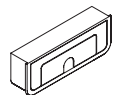

End/Back Panel Grommet

The end/back panel grommets are standard, for any special consideration contact Customer Service.

Support Furniture

Lectern

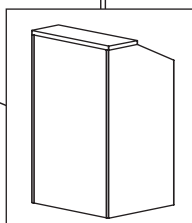
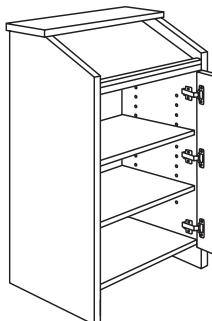

- concealed locking casters
- adjustable shelves
- see page 322 for power and data options

Visual Board

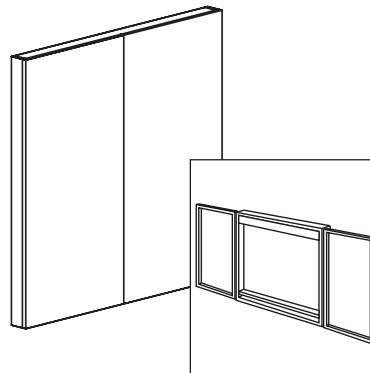

- tackable surface on interior of the doors
- includes two markers and eraser

Vision Laminate Conference Product Information

Finish and Product Reference Codes

Select	Code
--------	------

Veneer Wood Grain Laminates

Autumn	AUT
Blond Echo	BLO
Bourbon	BBN
Brazilwood	BZW
Brighton	BRG
High Line	HGL
Shea	SHE
Studio Teak	STU
Walnut Heights	WLH
Vintage	VIN

Solid Laminates

Alabaster	ALB
Bridal Blanco	BBL
Designer White	DWH
Dove Grey	DOV
Graphite	GRH
Shadow	SHD
Slate Grey	SLG
Taupe	TAU

Top Edge Details

Eased	R3
Reeded	H3
Transitional	C3

Select	Code
--------	------

Pull & Finish Codes

Bar - Matte Nickel	MBK
Bar - Polished Nickel	PNK
Fluent - Matte Black	MBK
Fluent - Matte Nickel	MNK
Healy - Matte Nickel	MNK
Reveal - Matte Nickel	MNK
Sweep - Matte Black	MBK
Sweep - Matte Nickel	MNK

Grommet Finish

Matte Black	MBK
Stardust Silver	STS

Metal T/Y/X/X-4 Bases Finish

▲ Black Sandtex	BSX
▲ Stardust Silver	STS

Order Check List:

Specify:

- 1. Model Number
- 2. Finish
- 3. Laminate
- 4. Other Product Options
- 5. Power and Data Accessories (*drawing showing location and orientation must accompany order*)
- 6. Side Mark Information (*i.e. room number, East Conference Room*)
- 7. Shipping Address (*contact name and phone number*)
- 8. Special Delivery Instructions (*i.e. call before delivery, deliver to job site*)

Description	D	W	Seating Capacity	Top Pieces	Bases Required	CTN WT	CU FT	Model	TFL List Price	HPL List Price
Rectangular Conference Table Top	48	144	12	2	3	296	28	VL48144TT	\$1,553	\$1,634
	48	120	8	2	2	245	22	VL48120TT**	\$1,507	\$1,586



· 3" radius corners

** When ordering Elliptical or Rectangular bases - VL48120TT requires (3) bases and additional stretchers. Stretchers will be included as required.

Rectangular Conference Table Top	48	96	8	1	2	197	17	VL4896TT	\$1,189	\$1,252
	42	96	8	1	2	172	15	VL4296TT	\$1,078	\$1,133
	42	84	8	1	2	151	13	VL4284TT	\$1,010	\$1,062
	36	72	6	1	2	110	10	VL3672TT	\$760	\$800

Now!



· 3" radius corners

Racetrack Conference Table Top	48	144	12	2	3	277	28	VL48144RT	\$1,797	\$1,892
	48	120	8	2	2	226	22	VL48120RT**	\$1,722	\$1,813



** When ordering Elliptical or Rectangular bases - VL48120RT requires (3) bases and additional stretchers. Stretchers will be included as required.

Racetrack Conference Table Top	48	96	8	1	2	185	17	VL4896RT	\$1,349	\$1,419
	42	96	8	1	2	157	15	VL4296RT	\$1,237	\$1,302
	42	84	8	1	2	142	13	VL4284RT	\$1,162	\$1,223
	36	72	6	1	2	100	10	VL3672RT	\$810	\$852



Boat Shape Conference Table Top	48	144	12	2	3	277	28	VL48144BT	\$1,797	\$1,892
	48	120	8	2	2	226	22	VL48120BT**	\$1,722	\$1,813



· 3" radius corners

** When ordering Elliptical or Rectangular bases - VL48120BT requires (3) bases and additional stretchers. Stretchers will be included as required.

Boat Shape Conference Table Top	48	96	8	1	2	185	17	VL4896BT	\$1,349	\$1,419
	42	96	8	1	2	157	15	VL4296BT	\$1,237	\$1,302
	42	84	8	1	2	142	13	VL4284BT	\$1,162	\$1,223
	36	72	6	1	2	100	10	VL3672BT	\$810	\$852

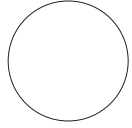

· 3" radius corners

Description	D	W	Seating Capacity	Top Pieces	Bases Required	CTN WT	CU FT	① Model	TFL List Price	HPL List Price
Round Tops	60	N/A	6	1	1	112	10	VL60TT	\$849	\$893
	54	N/A	6	1	1	92	8	VL54TT	\$812	\$854
	48	N/A	4	1	1	73	7	VL48TT	\$670	\$705
	42	N/A	4	1	1	56	5	VL42TT	\$598	\$628
	36	N/A	3	1	1	42	4	VL36TT	\$520	\$548
	30	N/A	3	1	1	30	3	VL30TT	\$497	\$523

VISION - LAMINATE

To Order, Specify:

- ① Model Number
- ② Worksurface Material (see page 246)
 - a.) TFL
 - b.) HPL
- ③ Laminate Color (see page 246)
- ④ Edge Profile (see page 247)
- ⑤ Power and Data Options (see page 322)
- ⑥ Other Product Options

When ordering Quickship products, place a "Q" in front of model number.
 Example: QVL3072DD



Description	D	W	Top Pieces	Base Required	CTN WT	CU FT	① Model	TFL List Price	HPL List Price
Configuration Docking Table Top	30	72	1	2	75	10	VL3072CT	\$815	\$857

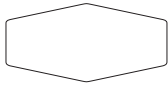

- 3" radius corners
- includes metal stiffener rail
- specify either of the following compatible bases:
 - (2) VS2626T - Adjustable Glide Base/Non-Tilt Top
 - (2) VS2626TC -Caster Base/Non-Tilt Top
 - (1) VS2626TT2 sold as set - Adjustable Glide Base/Tilt Top
 - (1) VS2626TCT2 sold as set - Caster Base/Tilt Top

Configuration Docking Table Top	24	60	1	2	60	7	VL2460CT	\$705	\$742
---------------------------------	----	----	---	---	----	---	----------	-------	-------

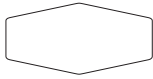

- 3" radius corners
- includes metal stiffener rail
- specify either of the following compatible bases:
 - (2) VS2020T - Adjustable Glide Base/Non-Tilt Top
 - (2) VS2020TC -Caster Base/Non-Tilt Top
 - (1) VS2020TT2 sold as set - Adjustable Glide Base/Tilt Top
 - (1) VS2020TCT2 sold as set - Caster Base/Tilt Top

Configuration Wing Table Top	36	90	1	2	95	13	VL3096WRCT	\$1,023	\$1,077
	36	90	1	2	95	13	VL3096WLCT	\$1,023	\$1,077



right



left

- 3" radius corners
- includes metal stiffener rail
- specify either of the following compatible bases:
 - (1) VS2626T and (1) VS2026CT - Adjustable Glide Base/Non-Tilt Top
 - (1) VS2626TC and (1) VS2026CTC - Caster Base/Non-Tilt Top
 - (1) VS2626CWT - Adjustable Glide Base/Tilt Top (sold as set of two bases)
 - (1) VS2626CWTC - Caster Base/Tilt Top (sold as set of two bases)

Configuration Wing Table Top	24	80	1	2	78	10	VL2480WRCT	\$907	\$954
	24	80	1	2	78	10	VL2480WLCT	\$907	\$954



right



left

- 3" radius corners
- includes metal stiffener rail
- specify either of the following compatible bases:
 - (1) VS2020T and (1) VS2026CT - Adjustable Glide Base/Non-Tilt Top
 - (1) VS2020TC and (1) VS2026CTC - Caster Base/Non-Tilt Top
 - (1) VS2620CWT - Adjustable Glide Base/Tilt Top (sold as set of two bases)
 - (1) VS2620CWTC - Caster Base/Tilt Top (sold as set of two bases)

Description	D	W	Top Pieces	Bases Required	CTN WT	CU FT	① Model	TFL List Price	HPL List Price
Configuration Rectangular Table Top	30	72	1	2	98	9	VL3072RECT	\$779	\$819
	30	66	1	2	94	8	VL3066RECT	\$765	\$805
	30	60	1	2	86	8	VL3060RECT	\$705	\$742



- 3" radius corners
- includes metal stiffener rail
- specify either of the following compatible bases:
 - (2) VS2626T - Adjustable Glide Base/Non-Tilt Top
 - (2) VS2626TC -Caster Base/Non-Tilt Top
 - (1) VS2626TT2 sold as set - Adjustable Glide Base/Tilt Top
 - (1) VS2626TCT2 sold as set - Caster Base/Tilt Top



Configuration Rectangular Table Top	24	72	1	2	85	9	VL2472RECT	\$690	\$726
	24	66	1	2	74	8	VL2466RECT	\$658	\$691
	24	60	1	2	62	8	VL2460RECT	\$600	\$632



- 3" radius corners
- includes metal stiffener rail
- specify either of the following compatible bases:
 - (2) VS2020T - Adjustable Glide Base/Non-Tilt Top
 - (2) VS2020TC -Caster Base/Non-Tilt Top
 - (1) VS2020TT2 sold as set - Adjustable Glide Base/Tilt Top
 - (1) VS2020TCT2 sold as set - Caster Base/Tilt Top

To Order, Specify:

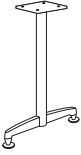
- ① Model Number
- ② Worksurface Material (see page 246)
 - a.) TFL
 - b.) HPL
- ③ Laminate Color (see page 246)
- ④ Edge Profile (see page 247)
- ⑤ Power and Data Options (see page 322)
- ⑥ Other Product Options

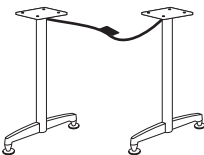
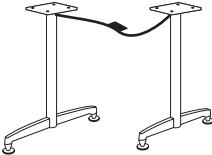
Description	D	W	H	CTN WT	CU FT	① Model	List Price
Metal T-Base - Non-Tilt 	2½	20	28	12	3	VS2020T - adjustable glides · for use with 24" width tops	\$306
	2½	20	28	12	3	VS2020TC - locking casters · for use with 24" width tops	\$282
	2½	26	28	13	3	VS2626T - adjustable glides · for use with 30" & 36" width tops	\$321
	2½	26	28	13	3	VS2626TC - locking casters · for use with 30" & 36" width tops	\$297
<ul style="list-style-type: none"> · adjustable leveler extensions black - allow caster selection without changing table height · specify Black Sandtex (BSX) or Stardust Silver (STS) base rail and column 							
Metal Cantilever T-Base - Non-Tilt 	2½	23	28	14	4	VS2026CT - adjustable glides	\$314
	2½	23	28	14	4	VS2026CTC - locking casters	\$290
<ul style="list-style-type: none"> · for use with 24" or 30" width tops and Wing Table Tops · adjustable leveler extensions black - allow caster selection without changing table height · specify Black Sandtex (BSX) or Stardust Silver (STS) base rail and column 							
Metal T-Base - Tilt 	2½	20	28	25	6	VS2020TT2 - adjustable glides · for use with 24" width tops	\$891
	2½	20	28	25	6	VS2020TCT2 - locking casters · for use with 24" width tops	\$882
	2½	26	28	25	6	VS2626TT2 - adjustable glides · for use with 30" & 36" width tops	\$948
	2½	26	28	25	6	VS2626TCT2 - locking casters · for use with 30" & 36" width tops	\$939
<ul style="list-style-type: none"> · includes 2 bases and cable · adjustable leveler extensions black - allow caster selection without changing table height · tilt is controlled from a single handle release for a set of two bases · specify Black Sandtex (BSX) or Stardust Silver (STS) base rail and column 							
Wing Table Metal T-Base - Tilt 	2½	23	28	33	5	VS2620CWT - adjustable glides · for use on VL2480WRCT & VL2480WLCT	\$912
	2½	23	28	33	5	VS2620CWTC - locking casters · for use on VL2480WRCT & VL2480WLCT	\$903
	2½	26	28	35	5	VS2626CWT - adjustable glides · for use on VL3096WRCT & VL3096WLCT	\$928
	2½	26	28	35	5	VS2626CWTC - locking casters · for use on VL3096WRCT & VL3096WLCT	\$919
<ul style="list-style-type: none"> · VS2620CWT & VS2620CWTC includes one 23" wide base, one 20" wide base, and cable activation lever · VS2626CWT & VS2626CWTC includes one 26" wide base, one 23" wide base, and cable activation lever · adjustable leveler extensions black - allow caster selection without changing table height · tilt is controlled from a single handle release for a set of two bases · specify Black Sandtex (BSX) or Stardust Silver (STS) base rail and column 							

Description	D	W	H	CTN WT	CU FT	① Model	List Price
Metal Y-Base	18	34	28	23	2	VS34Y - adjustable glides	\$449
NOW!	18	34	28	23	3	VS34YC - locking casters	\$424

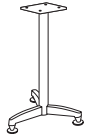

- for use with 36" round and 36" width tops
- adjustable leveler extensions black - allow caster selection without changing table height
- specify Black Sandtex (BSX) or Stardust Silver (STS) base rail and column

Metal X-Base	26	26	28	21	3	VS26X - adjustable glides	\$462
NOW!	26	26	28	21	3	VS26XC - locking casters	\$437
	34	34	28	25	3	VS34X - adjustable glides	\$522
	34	34	28	25	3	VS34XC - locking casters	\$497
	38	38	28	27	3	VS38X - adjustable glides	\$554
	38	38	28	27	3	VS38XC - locking casters	\$529

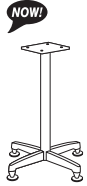

- adjustable leveler extensions black - allow caster selection without changing table height
- specify Black Sandtex (BSX) or Stardust Silver (STS) base rail and column

Metal X4-Base	38	38	28	35	3	VS38X4	\$943
---------------	----	----	----	----	---	---------------	-------

NOW!

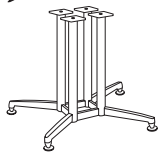

- for use with 54" and 60" round tops
- adjustable leveler extensions are black
- specify Black Sandtex (BSX) or Stardust Silver (STS) rails and columns

To Order, Specify:

- ① Model Number
- ② Finish Color (see page 249)
- ③ Other Product Options

When ordering Quickship products, place a "Q" in front of model number.
Example: QVL3072DD

NOW!
Need it.
JSI Quickship

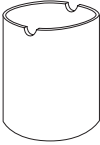
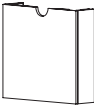
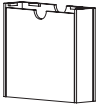
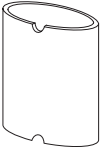
Description	D	W	H	CTN WT	CU FT	① Model	List Price
Cylinder Base 	24	N/A	28 ¾	37	12	VL24RBA · for use with 48", 54" and 60" width tops	\$933
	18	N/A	28 ¾	31	7	VL18RBA · for use with 30", 36" and 42" width tops	\$907
<ul style="list-style-type: none"> · includes wire access panel · available in <i>BLK-Black, SLV-Silver Laminate or any Vision laminate</i> ▲ 							
Rectangular Base  	7 ½	24	28 ¾	52	5	VL2428PBA · for use with 36", 42" and 48" width tops	\$653
	<ul style="list-style-type: none"> · includes wire access panel · available in <i>BLK-Black, SLV-Silver Laminate or any Vision laminate</i> ▲ 						
<ul style="list-style-type: none"> · includes wire access panel · available in <i>BLK-Black, SLV-Silver Laminate or any Vision laminate</i> ▲ 							
Ellipse Base 	9	24	28	48	12	VL2428EBA · for use with 36", 42" and 48" width tops	\$935
	<ul style="list-style-type: none"> · includes wire access panel · available in <i>BLK-Black, SLV-Silver Laminate or any Vision laminate</i> ▲ 						

VISION - LAMINATE

Description	D	W	H	CTN WT	CU FT	① Model	TFL List Price	HPL List Price
Lectern	22 [▲]	27	48	250	23	VL2622LEC	\$1,376	\$1,404

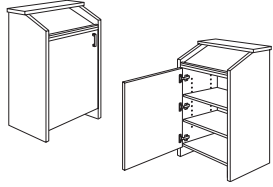

- two adjustable shelves
- four concealed non-locking casters
- non-locking
- standard door is hinged on left
- round grommet in bottom panel
- notches in adjustable shelves allow wires to pass through

Description	D	W	H	CTN WT	CU FT	① Model	List Price
Visual Board	48	48	3½	120	8	VL4848VB	\$1,679

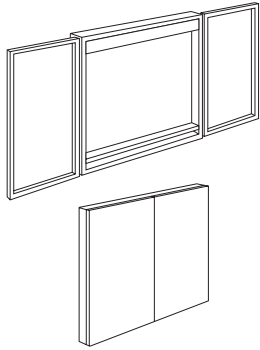

- tackboards on right and left; *Culp Montgomery Sterling panel fabric standard*[▲]
- marker board in center section
- four markers and eraser included
- locking not available

VISION - LAMINATE

To Order, Specify:

- ① Model Number
- ② Worksurface Material (see page 246)
 - a.) TFL
 - b.) HPL
- ③ Laminate Color (see page 246)
- ④ Other Product Options

When ordering Quickship products, place a "Q" in front of model number.
Example: QVL3072DD



Description	D	W	H	CTN WT	CU FT	① Model	TFL List Price	HPL List Price
-------------	---	---	---	-----------	----------	---------	-------------------	-------------------

Buffet Credenza	24	72	36	316	43	VL2472BSC	\$2,162	\$2,276
------------------------	----	----	----	-----	----	-----------	---------	---------

NOW!

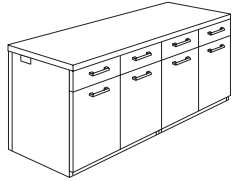

- four door credenza
- four box drawers above doors
- top edge profile on user side
- two end panel grommets with wire pass thru
- adjustable shelf in storage cabinets
- locking doors and drawers not available

	24	72	36	316	43	VL2472BSCT	\$2,538	\$2,617
--	----	----	----	-----	----	------------	---------	---------

Buffet Credenza - Flat Screen Support

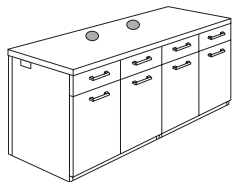

	20	72	36	291	31	VL2072BSCT	\$2,451	\$2,527
--	----	----	----	-----	----	------------	---------	---------

- four door credenza
- four box drawers above doors
- top edge profile on user side
- two end panel grommets with wire pass thru
- adjustable shelf in storage cabinets
- locking doors and drawers not available
- flat screen mounting grommets in top
- back panel includes cord exit grommets
- flat screen mounting frame sold separately, see page 322

Buffet Credenza	24	36	36	167	22	VL2436BSC	\$1,433	\$1,507
------------------------	----	----	----	-----	----	-----------	---------	---------

NOW!



	20	36	36	155	16	VL2036BSC	\$1,375	\$1,446
--	----	----	----	-----	----	-----------	---------	---------

- two door credenza
- two box drawers above doors
- top edge profile on user side
- two end panel grommets with wire pass thru
- adjustable shelf in storage cabinet
- locking doors and drawers not available

Buffet Credenza - Flat Screen Support	24	36	36	167	22	VL2436BSCT	\$1,793	\$1,848
--	----	----	----	-----	----	------------	---------	---------

Support



	20	36	36	155	16	VL2036BSCT	\$1,734	\$1,788
--	----	----	----	-----	----	------------	---------	---------

- two door credenza
- two box drawers above doors
- top edge profile on user side
- two end panel grommets with wire pass thru
- adjustable shelf in storage cabinet
- locking doors and drawers not available
- flat screen mounting grommets in top
- back panel includes cord exit grommets
- flat screen mounting frame sold separately, see below

Description	D	W	H	CTN WT	CU FT	① Model	List Price
-------------	---	---	---	-----------	----------	---------	------------

Flat Screen Mounting Frame	2	14	55	35	4	FSTV	\$1,236
-----------------------------------	---	----	----	----	---	------	---------

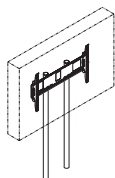

- round 2" tube frame with cable management to inside of credenza
- mounting bracket for TV provided (see page 322)
- available in black (B) or silver (S)
- TV not included
- coordinates with VL2472BSCT and VL2436BSCT

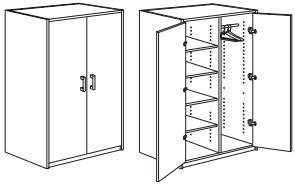
Description	D	W	H	CTN WT	CU FT	① Model	List Price
72" h Wardrobe	24	36	72	226	43	VL2436-72W	\$1,938
NOW!	24	30	72	212	36	VL2430-72W	\$1,777
	20	36	72	197	36	VL2036-72W	\$1,741
	20	30	72	185	31	VL2030-72W	\$1,688

- chrome hanging bar on right
- one fixed shelf second from bottom on left
- three adjustable shelves
- locking doors available, specify and add \$210 list

Hanging Bar to Shelves Conversion Kit NOW! 	$\frac{3}{4}$	18	2	VL1824SK	\$514
	$\frac{3}{4}$	15	2	VL1524SK	\$509
	$\frac{3}{4}$	16	2	VL1820SK	\$489
	$\frac{3}{4}$	14	2	VL1520SK	\$483

- four shelves
- VL1824SK - for VL2436-84W and VL2436-72W
- VL1524SK - for VL2430-84W and VL2430-72W
- VL1820SK - for VL2036-84W and VL2036-72W
- VL1520SK - for VL2030-84W and VL2030-72W

72" h Wardrobe NOW! 	24	18	72	155	23	VL2418-72WR	\$1,277
	24	18	72	155	23	VL2418-72WL	\$1,277
	20	18	72	135	19	VL2018-72WR	\$1,213
	20	18	72	135	19	VL2018-72WL	\$1,213

right shown

- chrome hanging bar on right
- one fixed shelf 29" from cabinet floor
- one adjustable shelf
- locking door available, specify and add \$105 list

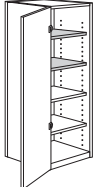
Hanging Bar to Shelves Conversion Kit NOW! 	$\frac{3}{4}$	16	2	VL1624SK	\$402
	$\frac{3}{4}$	14	2	VL1620SK	\$390

- two shelves
- VL1624SK - for VL2418-84WR/WL and VL2418-72WR/WL
- VL1620SK - for VL2018-84WR/WL and VL2018-72WR/WL

To Order, Specify:

Credenza

- ① Model Number
- ② Worksurface Material (see page 246)
 - a.) TFL
 - b.) HPL
- ③ Laminate Color (see page 246)
 - a.) Worksurface Color
 - b.) Chassis Color
 - c.) Drawer Color
- ④ Edge Profile (see page 247)
- ⑤ Pull Style and Color (see page 247)
- ⑥ Grommet Color (see page 248)

- ⑦ Power and Data Options (see page 322)
- ⑧ Other Product Options

Wardrobe

- ① Model Number
- ② Laminate Color (see page 246)
 - a.) Chassis Color
 - b.) Door Color
- ③ Pull Style and Color (see page 247)
- ④ Other Product Options

When ordering Quickship products, place a "Q" in front of model number.
 Example: QVL3072DD

NOW!
Need it.
 JSI Quickship

Vision Veneer Conference Product Information



VISION - VENEER

Vision Veneer Conference Product Information

Exterior Wood Materials

Exterior surfaces are made from the finest selected veneers to achieve clarity and consistency in the Vision Veneer product line. To attain a pleasing, symmetrical pattern, all cherry, maple, walnut veneers in Vision Veneer are book-matched. All exterior solid lumber is matched to coordinate with the veneer.

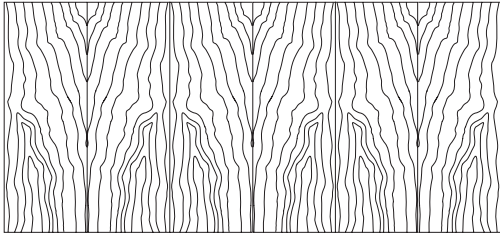

Book-Matched Example

Alternating pieces of veneer are flipped over so they face each other like the pages within a book

Vision Veneer is available in flat cut cherry, maple and walnut veneer. A wide range of wood stains have been formulated to enhance the beauty of the veneer.

Double Cut veneer is another choice on Vision Veneer product. This veneer is a processed product that has at least two cuttings to create the final veneers. These cuts of veneer strands are dyed and layered into a block to create variation of patterns from a very tight grain pattern to an exotic figure grain pattern. The diagram below show the tight pattern used on Vision Veneer. Use the appropriate pricing column when specifying Double Cut veneer.

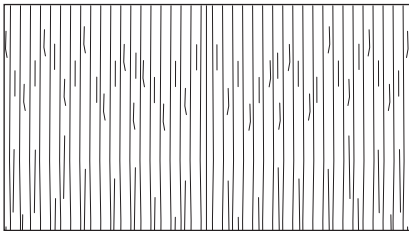

Solid painted finishes on MDF are also offered to provide an accent to the Vision Veneer product.

Cherry veneer is the only veneer species available in the **NOW!** quickship program on the select models.

Work Surface Construction

Tops are 5-ply balanced construction, 1³/₁₆" thick with solid matching hardwood edges. Surfaces are available in wood veneer or high pressure laminate. No additional charge for using our coordinating high pressure laminate with a veneer grain pattern with finish wood edges.

Case Construction

Outside panels are 1³/₁₆" and joined together with dowels reinforced with screws, cleats and metal fasteners for increased stability. Leveling glides are set into solid hardwood blocks, which helps to prevent the leveling glide from tear out. Tops are secured to the chassis with top fastening cleats screwed to the inside of the panels.

Cabinet doors have 110° swing hinges to allow adequate access into the interior of the cabinet.

Drawers

The unidirectional V- Fold drawer box is a durable miter-fold drawer structure which is glued and doweled. The 1/2" thick drawer sides are wrapped in a high grade maple vinyl, with an attached front. The drawer front is attached to the four sided box.

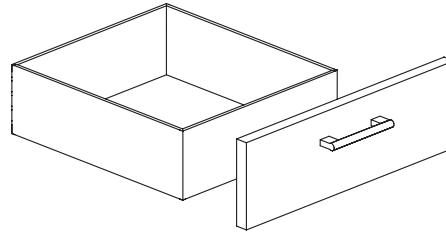

Optional four corner dovetailed wood drawers are available. Specify and add 10% per unit.

Drawer Suspension

High quality black drawer suspension carries a lifetime warranty. File and box drawers have 100% full extension with over travel. Slides feature steel ball bearings for longer wear and positive, cushioned in/out stops.

Locking

Locking

All free standing credenzas, and bench height credenza feature pedestal locking.

Units are shipped randomly keyed as standard. Key alike units are available upon request for no additional charges. Removable cores for in-field re-keying are standard.

Vision Veneer Conference Product Information

Finish - Stain/Colors

We offer a variety of wood stains and paint colors on Vision Veneer. Please see the chart below. Samples are available upon request. Former finish names are listed in parentheses for reference.

CH1 Cherry *Flat Cut Veneer*

AUT Autumn (<i>Autumn Cherry</i>)	EAR Earthy
BRL Barley	LGC Legacy (<i>Legacy Cherry</i>)
BBN Bourbon (<i>Natural Cherry</i>)	PRL Praline (<i>Vintage Cherry</i>)
BRG Brighton (<i>Brighton Cherry</i>)	SAF Saffron (<i>Medium Cherry</i>)
CLA Classic (<i>Classic Cherry</i>)	

MA1 Maple *Flat Cut Veneer*

ALE Ale (<i>Natural Maple</i>)	FLX Flax
BUT Butterscotch	VEN Venetian (<i>Dark Mahogany</i>)
CIN Cinnamon	

WA1 Walnut *Flat Cut Veneer*

AUB Auburn (<i>Windsor Mahogany</i>)	SIE Sienna
ESP Espresso	TOF Toffee
MCH Mocha	TRF Truffle
NTO Night Owl (<i>Vintage Walnut</i>)	

DC1 Double Cut Veneer

COF Coffee	KHK Khaki
CRM Cremello	STU Studio Teak
GRH Graphite	

Protective Top Coat

DuraTex™ offers exceptional hardness along with abrasion and impact resistance, it has been formulated to eliminate hazardous and harmful gases that are normally associated with wood finish.

DuraTex™ Features

- Safety - Significantly reduces hazardous formaldehyde emissions which help improve the quality of the indoor air we breathe.
- Quality - Developed to be tough and durable with special attention to appearance. The DuraTex™ finish preserves the natural beauty of wood.
- Durability - Designed to meet a wide range of demanding performance and environmental standards to withstand even the highest wear and tear.

Special Finishes

Special finishes can be requested by following the instruction in the general introduction section, page 3. There is a one time charge of \$289 list per order.

Product Modification

Laminate Tops

Work surface only, no additional upcharge if Vision Veneer's coordinating wood grain laminate is specified. Contact Customer Service for any other laminate request. Listed below are finishes that have coordinating wood grain HPL laminates.

Cherry Finishes	Maple Finishes	Walnut Finishes
<i>Autumn</i>	<i>Ale</i>	<i>Auburn</i>
<i>Barley</i>	<i>Cinnamon</i>	<i>Mocha</i>
<i>Bourbon</i>	<i>Venetian</i>	<i>Night Owl</i>
<i>Brighton</i>		<i>Sienna</i>
<i>Classic</i>		<i>Toffee</i>
<i>Legacy</i>		<i>Truffle</i>
<i>Praline</i>		
<i>Saffron</i>		

Oak Veneer

Upon request veneer can be changed from the standard offering to oak plain sliced veneer with a 40% upcharge on to the list of each item.

Wood Drawers

Four corner dovetailed wood drawers must be specified at the time of order placement. There is a 10% upcharge added to the list of each item.

Finish Sheen Modification

Finish sheen can be modified on the work surface tops. There is a 15% upcharge added to the list of each item.

Special Construction

Vision Veneer offers large offering to create many types of configuration. Contact Customer Service if you are having trouble with finding the right units to complete the desired configuration. Requests need to be approved by JSI engineering.

Vision Veneer Conference Product Information

Top Edge Details

All four edges can have a HPL surfaces.

Edges (Eased, Reeded and Transitional can be used on any Vision Veneer tops.

Bevel Edge can only be used on Vision Veneer conference tops.

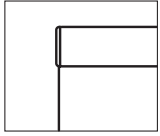

Eased (R3)

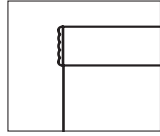

Reeded (H3)

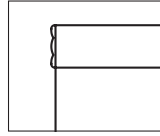

Transitional (C3)

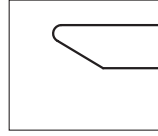

Reverse Knife (R)

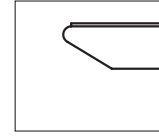

Reverse Knife (R)
with laminate top

Drawer Pull Style and Color Options

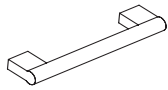

Bar
Matte Black (MBK)
Polished Nickel (PNK)



Fluent
Matte Black (MBK)
Matte Nickel (MNK)



Healy
Matte Nickel (MNK)

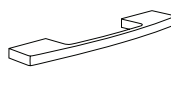

Reveel
Matte Nickel (MNK)



Sweep
Matte Black (MBK)
Matte Nickel (MNK)

Top Shapes - size - base requirement - seating capacity

top sizes 108" through 192" are 2 pieces

top sizes above 192" are 3 pieces

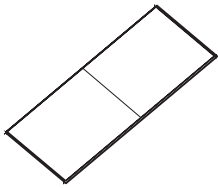

size	bases	seats
264" x 60"	4 bases	seats 24
240" x 60"	4 bases	seats 22
216" x 60"	4 bases	seats 20
192" x 60"	3 bases	seats 18
264" x 54"	4 bases	seats 22
240" x 54"	4 bases	seats 20
216" x 54"	4 bases	seats 18
192" x 54"	3 bases	seats 16
264" x 48"	4 bases	seats 22
240" x 48"	4 bases	seats 20
216" x 48"	4 bases	seats 18
192" x 48"	3 bases	seats 16
168" x 48"	3 bases	seats 14
144" x 48"	3 bases	seats 12
120" x 48"	2 bases	seats 8
120" x 42"	2 bases	seats 8
108" x 42"	2 bases	seats 8
96" x 48"	2 bases	seats 8
96" x 42"	2 bases	seats 8
84" x 42"	2 bases	seats 8
72" x 36"	2 bases	seats 6

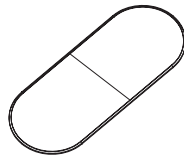

size	bases	seats
264" x 60"	4 bases	seats 24
240" x 60"	4 bases	seats 22
216" x 60"	4 bases	seats 20
192" x 60"	3 bases	seats 18
264" x 54"	4 bases	seats 22
240" x 54"	4 bases	seats 20
216" x 54"	4 bases	seats 18
192" x 54"	3 bases	seats 16
264" x 48"	4 bases	seats 22
240" x 48"	4 bases	seats 20
216" x 48"	4 bases	seats 18
192" x 48"	3 bases	seats 16
168" x 48"	3 bases	seats 14
144" x 48"	3 bases	seats 12
120" x 48"	2 bases	seats 8
120" x 42"	2 bases	seats 8
108" x 42"	2 bases	seats 8
96" x 48"	2 bases	seats 8
96" x 42"	2 bases	seats 8
84" x 42"	2 bases	seats 8
72" x 36"	2 bases	seats 6

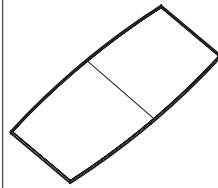

size	bases	seats
264" x 60"	4 bases	seats 22
240" x 60"	4 bases	seats 20
216" x 60"	4 bases	seats 18
192" x 60"	3 bases	seats 16
264" x 54"	4 bases	seats 22
240" x 54"	4 bases	seats 20
216" x 54"	4 bases	seats 18
192" x 54"	3 bases	seats 16
264" x 48"	4 bases	seats 22
240" x 48"	4 bases	seats 20
216" x 48"	4 bases	seats 18
192" x 48"	3 bases	seats 16
168" x 48"	3 bases	seats 14
144" x 48"	3 bases	seats 12
120" x 48"	2 bases	seats 8
120" x 42"	2 bases	seats 8
108" x 42"	2 bases	seats 8
96" x 48"	2 bases	seats 8
96" x 42"	2 bases	seats 8
84" x 42"	2 bases	seats 8
72" x 36"	2 bases	seats 6



size	bases	seats
60" dia.	seats 6	
54" dia.	seats 6	
48" dia.	seats 4	
42" dia.	seats 4	
36" dia.	seats 3	
30" dia.	seats 3	

*requires 1 base



size	bases	seats
60" sq.	seats 8	
54" sq.	seats 6	
48" sq.	seats 4	
42" sq.	seats 4	
36" sq.	seats 4	
30" sq.	seats 4	

*requires 1 base

Vision Veneer Conference Product Information

Table Base (units with access panel in the base for wire management are available, order this feature with the appropriate model number.)

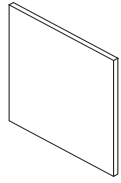

panel base
36", 30" and 24" width

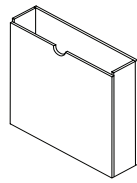

rectangle base
36", 30" and 24" width

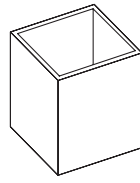

square base
30", 24" and 18" width

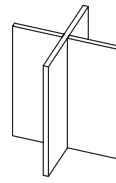

cross base
30", 24" and 18" width

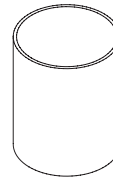

round base
24", 20" and 18" dia.



half-round base
24", 20" and 18" dia.

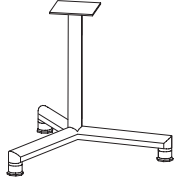

Metal Y Base
34" Span

- fixed base style
- fixed base with casters*

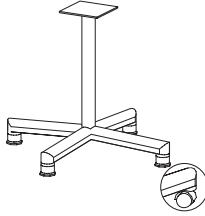

Metal X Base
38" Span
34" Span
26" Span

- fixed base style
- fixed base with casters*

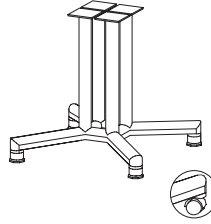

Cantilever T Base
38" Span

- fixed base style

Vision Veneer Conference Product Information

Grommets

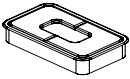

Worksurface Grommet

Additional worksurface grommets can be specified on veneer/laminate worksurfaces. The grommet location must be approved by JSI manufacturing, contact Customer Service. Add \$79 to the list for each additional grommet.

Grommet color must be specified, select Matte Black or Stardust Silver. Lock cores will match grommet color

Matte Black (MBK)

Stardust Silver (STS)

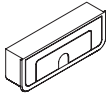

End/Back Panel Grommet

The end/back panel grommets are standard, for any special consideration contact Customer Service.

Support Furniture

Lectern

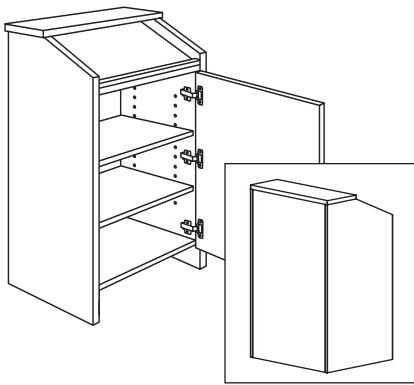

- concealed locking casters
- adjustable shelves
- see page 322 for power and data options

Visual Board

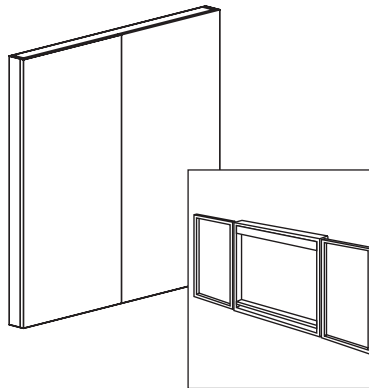

- tackable surface on interior of the doors
- includes two markers and eraser

Vision Veneer Conference Product Information

Finish and Reference Codes - Summary

Select Veneer/Substrate	Code	Select Pull & Finish Codes	Code	Select Laminate Coordinates	Code
Cherry	CH1	Bar - Matte Nickel	MBK	Cherry Wood Grain Patterns	
Maple	MA1	Bar - Polished Nickel	PNK	Autumn	AUT
Walnut	WA1	Fluent - Matte Black	MBK	Barley	BRL
Double Cut	DC1	Fluent - Matte Nickel	MNK	Bourbon	BBN
Finish		Healy - Matte Nickel	MNK	Brighton	BRG
Cherry Finishes		Reveel - Matte Nickel	MNK	Classic	CLA
Autumn	AUT	Sweep - Matte Black	MBK	Legacy	LGC
Barley	BRL	Sweep - Matte Nickel	MNK	Praline	PRL
Bourbon	BBN			Saffron	SAF
Brighton	BRG	Grommet Finish		Maple Wood Grain Patterns	
Classic	CLA	Matte Black	MBK	Ale	ALE
Earthy	EAR	Stardust Silver	STS	Cinnamon	CIN
Legacy	LGC			Venetian	VEN
Praline	PRL	Metal T/Y/X/X-4 Bases Finish		Walnut Wood Grain Patterns	
Saffron	SAF	▲ Black Sandtex	BSX	Auburn	AUB
Maples Finishes		▲ Stardust Silver	STS	Mocha	MCH
Ale	ALE			Night Owl	NTO
Butterscotch	BUT			Sienna	SIE
Cinnamon	CIN			Toffee	TOF
Flax	FLX			Truffle	TRF
Venetian	VEN				
Walnut Finishes		Drawer Box			
Auburn	AUB	Wood Drawers	DRM001		
Espresso	ESP	Vinyl Wrapped Drawers	DRM002		
Mocha	MCH				
Night Owl	NTO				
Sienna	SIE				
Toffee	TOF				
Truffle	TRF				
Double Cut Finishes					
Coffee	COF				
Cremello	CRM				
Graphite	GRH				
Khaki	KHK				
Studio Teak	STU				

Order Check List:

Specify:

- 1. Model Number
- 2. Finish
- 3. Wood Species - cherry - maple - walnut - double cut (use the appropriate pricing column to determine list price)
- 4. Top Options - edge and worksurface - veneer or laminate
- 5. Other Product Options
- 6. Power and Data Accessories (*drawing showing location and orientation must accompany order*)
- 7. Side Mark Information (*i.e. room number, East Conference Room*)
- 8. Shipping Address (*contact name and phone number*)
- 9. Special Delivery Instructions (*i.e. call before delivery, deliver to job site*)

Description	D	W	H	CTN WT	CU FT	① Model	Flat Cut List Price	Double Cut List Price
-------------	---	---	---	-----------	----------	---------	------------------------	--------------------------

Conference Table	42	96	30			VV4296CTP	\$3,667	\$4,036
------------------	----	----	----	--	--	-----------	---------	---------

NOW!

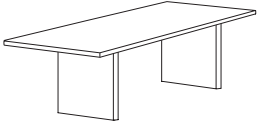

Consists of:

	172	15	VV4296TT - Table Top	\$2,617	\$2,880
	54	4	VV2428PB - Panel Base	\$1,050	\$1,156

- ships KD in two cartons
- price reflects two bases
- must order (2) panel bases

Conference Table	36	72	30			VV3672CTP	\$2,733	\$3,008
------------------	----	----	----	--	--	-----------	---------	---------

NOW!

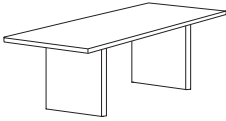

Consists of:

	110	10	VV3672TT - Table Top	\$1,683	\$1,852
	54	4	VV2428PB - Panel Base	\$1,050	\$1,156

- ships KD in two cartons
- price reflects two bases
- must order (2) panel bases

Round Conference Table	48	48	30			VV48CTD	\$2,097	n/a
------------------------	----	----	----	--	--	---------	---------	-----

NOW!

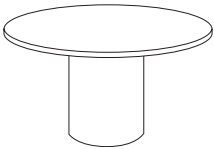

Consists of:

	73	7	VV48TT - Table Top	\$1,293	n/a
	71	9	VV20RB - Round Base	\$804	n/a

- ships KD in two cartons

Round Conference Table	42	42	30			VV42CTD	\$1,804	n/a
------------------------	----	----	----	--	--	---------	---------	-----

NOW!

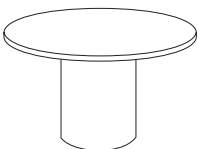

Consists of:

	56	5	VV42TT - Table Top	\$1,000	n/a
	71	9	VV20RB - Round Base	\$804	n/a

- ships KD in two cartons

Description	D	W	Seating Capacity	Top Pieces	Bases Required	CTN WT	CU FT	① Model	Flat Cut List Price	Double Cut List Price
Rectangular Conference Table Top 	60	264	24	3	4	673	57	VV60264TT	\$11,053	\$12,158
	60	240	22	3	4	613	51	VV60240TT	\$10,047	\$11,052
	60	216	20	3	4	552	48	VV60216TT	\$9,044	\$9,949
	54	264	22	3	4	609	52	VV54264TT	\$9,211	\$10,133
	54	240	20	3	4	554	50	VV54240TT	\$8,373	\$9,211
	54	216	18	3	4	498	43	VV54216TT	\$7,537	\$8,291
	48	264	22	3	4	548	47	VV48264TT	\$8,189	\$9,008
	48	240	20	3	4	498	43	VV48240TT	\$7,445	\$8,189
	48	216	18	3	4	447	38	VV48216TT	\$6,698	\$7,368

Rectangular Conference Table Top 	60	192	18	2	3	490	42	VV60192TT	\$8,038	\$8,843
	54	192	16	2	3	441	38	VV54192TT	\$6,698	\$7,368
	48	192	16	2	3	396	33	VV48192TT	\$5,956	\$6,552
	48	168	14	2	3	346	30	VV48168TT	\$5,213	\$5,735
	48	144	12	2	3	296	28	VV48144TT	\$4,467	\$4,914
	48	120	8	2	2	245	22	VV48120TT**	\$3,724	\$4,097
	42	120	8	2	2	217	19	VV42120TT**	\$3,258	\$3,584
	42	108	8	2	2	195	17	VV42108TT	\$2,934	\$3,228

** When ordering Elliptical or Rectangular bases - VV48120TT and VV42120TT require (3) bases and additional stretchers. Stretchers will be included as required.

Rectangular Conference Table Top NOW! 	48	96	8	1	2	197	17	VV4896TT	\$2,991	\$3,290
	42	96	8	1	2	172	15	VV4296TT	\$2,617	\$2,880
	42	84	8	1	2	151	13	VV4284TT	\$2,278	\$2,506
	36	72	6	1	2	110	10	VV3672TT	\$1,683	\$1,852

To Order, Specify:

- ① Model Number
- ② Wood Species - Cherry (CH1), Maple (MA1), Walnut (WA1) or Double Cut (see page 263)
- ③ Finish Color (see page 263)
- ④ Edge Profile (see page 264)
- ⑤ Power and Data Options (see page 264)
- ⑥ Other Product Options

When ordering Quickship products, place a "Q" in front of model number.
 Example: QVV3072DD



NOW!
 Need it.
 JSI Quickship

Description	D	W	Seating Capacity	Top Pieces	Bases Required	CTN WT	CU FT	Model	Flat Cut List Price	Double Cut List Price
Racetrack Conference Table Top 	60	264	24	3	4	646	57	VV60264RT	\$13,061	\$14,368
	60	240	22	3	4	589	51	VV60240RT	\$11,874	\$13,061
	60	216	20	3	4	530	48	VV60216RT	\$10,687	\$11,756
	54	264	22	3	4	586	52	VV54264RT	\$10,884	\$11,973
	54	240	20	3	4	530	50	VV54240RT	\$9,895	\$10,885
	54	216	18	3	4	474	43	VV54216RT	\$8,907	\$9,798
	48	264	22	3	4	529	47	VV48264RT	\$9,675	\$10,643
	48	240	20	3	4	479	43	VV48240RT	\$8,795	\$9,675
	48	216	18	3	4	428	38	VV48216RT	\$7,917	\$8,709

Racetrack Conference Table Top 	60	192	18	2	3	471	42	VV60192RT	\$9,501	\$10,451
	54	192	16	2	3	417	38	VV54192RT	\$7,917	\$8,709
	48	192	16	2	3	377	33	VV48192RT	\$7,038	\$7,742
	48	168	14	2	3	327	30	VV48168RT	\$6,179	\$6,797
	48	144	12	2	3	277	28	VV48144RT	\$5,279	\$5,807
	48	120	8	2	2	226	22	VV48120RT**	\$4,403	\$4,844
	42	120	8	2	2	203	19	VV42120RT**	\$3,850	\$4,235
	42	108	8	2	2	180	17	VV42108RT	\$3,467	\$3,814

** When ordering Elliptical or Rectangular bases - VV48120RT and VV42120RT require (3) bases and additional stretchers. Stretchers will be included as required.

Racetrack Conference Table Top 	48	96	8	1	2	185	17	VV4896RT	\$3,520	\$3,873
	42	96	8	1	2	157	15	VV4296RT	\$3,081	\$3,390
	42	84	8	1	2	142	13	VV4284RT	\$2,706	\$2,977
	36	72	6	1	2	100	10	VV3672RT	\$1,983	\$2,181

Description	D	W	Seating Capacity	Top Pieces	Bases Required	CTN WT	CU FT	① Model	Flat Cut List Price	Double Cut List Price
Boat Shape Conference Table Top 	60	264	24	3	4	646	57	VV60264BT	\$13,061	\$14,368
	60	240	22	3	4	589	51	VV60240BT	\$11,874	\$13,061
	60	216	20	3	4	530	48	VV60216BT	\$10,687	\$11,756
	54	264	22	3	4	586	52	VV54264BT	\$10,884	\$11,973
	54	240	20	3	4	530	50	VV54240BT	\$9,895	\$10,885
	54	216	18	3	4	474	43	VV54216BT	\$8,907	\$9,798
	48	264	22	3	4	529	47	VV48264BT	\$9,675	\$10,643
	48	240	20	3	4	479	43	VV48240BT	\$8,795	\$9,675
	48	216	18	3	4	428	38	VV48216BT	\$7,917	\$8,709
	60	192	18	2	3	471	42	VV60192BT	\$9,501	\$10,451
Boat Shape Conference Table Top 	54	192	16	2	3	417	38	VV54192BT	\$7,917	\$8,709
	48	192	16	2	3	377	33	VV48192BT	\$7,038	\$7,742
	48	168	14	2	3	327	30	VV48168BT	\$6,179	\$6,797
	48	144	12	2	3	277	28	VV48144BT	\$5,279	\$5,807
	48	120	8	2	2	226	22	VV48120BT**	\$4,403	\$4,844
	42	120	8	2	2	203	19	VV42120BT**	\$3,850	\$4,235
	42	108	8	2	2	180	17	VV42108BT	\$3,467	\$3,814
	** When ordering Elliptical or Rectangular bases - VV48120BT and VV42120BT require (3) bases and additional stretchers. Stretchers will be included as required.									
Boat Shape Conference Table Top 	48	96	8	1	2	185	17	VV4896BT	\$3,520	\$3,873
	42	96	8	1	2	157	15	VV4296BT	\$3,081	\$3,390
	42	84	8	1	2	142	13	VV4284BT	\$2,706	\$2,977
	36	72	6	1	2	100	10	VV3672BT	\$1,983	\$2,181

To Order, Specify:

- ① Model Number
- ② Wood Species - Cherry (CH1), Maple (MA1), Walnut (WA1) or Double Cut (see page 263)
- ③ Finish Color (see page 263)
- ④ Edge Profile (see page 264)
- ⑤ Power and Data Options (see page 322)
- ⑥ Other Product Options

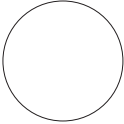
Description	D	W	Seating Capacity	Top Pieces	Bases Required	CTN WT	CU FT	① Model	Flat Cut List Price	Double Cut List Price
Round Tops	60	N/A	6	1	1	112	10	VV60TT	\$2,215	\$2,436
NOW!	54	N/A	6	1	1	92	8	VV54TT	\$1,663	\$1,830
	48	N/A	4	1	1	73	7	VV48TT	\$1,293	\$1,423
	42	N/A	4	1	1	56	5	VV42TT	\$1,000	\$1,101
	36	N/A	3	1	1	42	4	VV36TT	\$880	\$969
	30	N/A	3	1	1	30	3	VV30TT	\$776	\$854

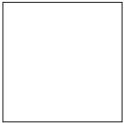
Description	D	W	Seating Capacity	Top Pieces	Bases Required	CTN WT	CU FT	① Model	Flat Cut List Price	Double Cut List Price
Square Tops	60	60	8	1	1	154	10	VV6060TT	\$2,029	\$2,233
	54	54	6	1	1	125	8	VV5454TT	\$1,535	\$1,689
	48	48	4	1	1	99	7	VV4848TT	\$1,212	\$1,334
	42	42	4	1	1	77	5	VV4242TT	\$929	\$1,022
	36	36	4	1	1	56	4	VV3636TT	\$838	\$922
	30	30	4	1	1	39	3	VV3030TT	\$583	\$642

Description	D	W	H	CTN WT	CU FT	① Model	Flat Cut List Price	Double Cut List Price
Panel Base	2 5/16	36	28 3/4	83	6	VV3628PB	\$632	\$696
NOW!	2 5/16	30	28 3/4	68	5	VV3028PB	\$580	\$639
	2 5/16	24	28 3/4	54	4	VV2428PB	\$525	\$578
						· for use with 60" width tops		
						· for use with 54" width tops		
						· for use with 36", 42" & 48" width tops		

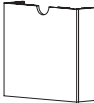
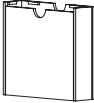
Description	D	W	H	CTN WT	CU FT	① Model	Flat Cut List Price	Double Cut List Price
Rectangular Base	7 5/8	36	28 3/4	69	7	VV3628PBA	\$1,067	\$1,174
NOW!	7 5/8	30	28 3/4	60	6	VV3028PBA	\$1,015	\$1,117
 	7 5/8	24	28 3/4	52	5	VV2428PBA	\$958	\$1,055
side 1						· for use with 60" width tops		
side 2						· access panel		
						· for use with 54" width tops		
						· access panel		
						· for use with 36", 42" & 48" width tops		
						· access panel		

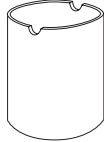
Description	D	W	H	CTN WT	CU FT	① Model	Flat Cut List Price	Double Cut List Price
Cylinder Base	24	N/A	28 3/4	74	12	VV24RB	\$915	n/a
NOW!	24	N/A	28 3/4	37	12	VV24RBA	\$1,022	n/a
	20	N/A	28 3/4	71	9	VV20RB	\$804	n/a
	20	N/A	28 3/4	34	9	VV20RBA	\$912	n/a
	18	N/A	28 3/4	68	7	VV18RB	\$752	n/a
	18	N/A	28 3/4	31	7	VV18RBA	\$860	n/a
						· for use with 54" & 60" width tops		
						· for use with 54" & 60" width tops		
						· access panel		
						· for use with 42" & 48" width tops		
						· for use with 42" & 48" width tops		
						· access panel		
						· for use with 30" & 36" width tops		
						· for use with 30" & 36" width tops		
						· access panel		

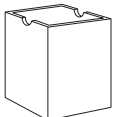
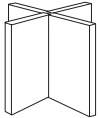
Description	D	W	H	CTN WT	CU FT	① Model	Flat Cut List Price	Double Cut List Price
Half Round Base 	12	24	28 3/4	35	6	VV24HRB · for use with 54" width tops	\$691	n/a
	12	24	28 3/4	33	6	VV24HRBA · for use with 54" width tops · access panel	\$813	n/a
	10	20	28 3/4	30	5	VV20HRB · for use with 42" and 48" width tops	\$630	n/a
	10	20	28 3/4	28	5	VV20HRBA · for use with 42" and 48" width tops · access panel	\$754	n/a
	9	18	28 3/4	27	4	VV18HRB · for use with 36" width tops	\$604	n/a
	9	18	28 3/4	26	4	VV18HRBA · for use with 36" width top · access panel	\$730	n/a
Square Base 	30	30	28 3/4	68	16	VV30SB · for use with 60" width tops	\$865	\$952
	30	30	28 3/4	68	16	VV30SBA · for use with 60" width tops · access panel	\$973	\$1,070
	24	24	28 3/4	68	12	VV24SB · for use with 48" & 54" width tops	\$763	\$839
	24	24	28 3/4	68	12	VV24SBA · for use with 48" & 54" width tops · access panel	\$871	\$958
	18	18	28 3/4	39	7	VV18SB · for use with 30", 36" & 42" width tops	\$658	\$724
	18	18	28 3/4	39	7	VV18SBA · for use with 30", 36" & 42" width tops · access panel	\$766	\$843
Cross Base 	30	30	28 3/4	80	16	VV30XB · for use with 60" width tops	\$716	\$788
	24	24	28 3/4	80	12	VV24XB · for use with 48" & 54" width tops	\$644	\$709
	18	18	28 3/4	50	7	VV18XB · for use with 30", 36" & 42" width tops	\$575	\$633

To Order, Specify:

- ① Model Number
- ② Wood Species - Cherry (CH1), Maple (MA1), Walnut (WA1) or Double Cut (see page 263)
- ③ Finish Color (see page 263)
- ④ Edge Profile (see page 264)
- ⑤ Other Product Options

When ordering Quickship products, place a "Q" in front of model number.
Example: QVV3072DD



VISION - VENEER

Description	D	W	H	CTN WT	CU FT	① Model	List Price
Metal Y-Base	18	34	28	23	2	VS34Y - adjustable glides	\$449
 Metal Y-Base	18	34	28	23	3	VS34YC - locking casters	\$424

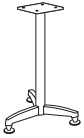

- for use with 36" round and 36" width tops
- adjustable leveler extensions black - allow caster selection without changing table height
- specify Black Sandtex (BSX) or Stardust Silver (STS) base rail and column

Metal X-Base	26	26	28	21	3	VS26X - adjustable glides	\$462
---------------------	----	----	----	----	---	----------------------------------	--------------

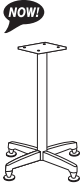

- for use with 30" round and 30" width tops

	26	26	28	21	3	VS26XC - locking casters	\$437
--	----	----	----	----	---	---------------------------------	--------------

- for use with 30" round and 30" width tops

	34	34	28	25	3	VS34X - adjustable glides	\$522
--	----	----	----	----	---	----------------------------------	--------------

- for use with 42" round and 42" width tops

	34	34	28	25	3	VS34XC - locking casters	\$497
--	----	----	----	----	---	---------------------------------	--------------

- for use with 42" round and 42" width tops

	38	38	28	27	3	VS38X - adjustable glides	\$554
--	----	----	----	----	---	----------------------------------	--------------

- for use with 48" round and 48" width tops

	38	38	28	27	3	VS38XC - locking casters	\$529
--	----	----	----	----	---	---------------------------------	--------------

- for use with 48" round and 48" width tops

- adjustable leveler extensions black - allow caster selection without changing table height
- specify Black Sandtex (BSX) or Stardust Silver (STS) base rail and column

Metal X4-Base	38	38	28	35	3	VS38X4	\$943
----------------------	----	----	----	----	---	---------------	--------------



- for use with 54" and 60" round tops
- adjustable leveler extensions are black
- specify Black Sandtex (BSX) or Stardust Silver (STS) rails and columns

Description	D	W	H	CTN WT	CU FT	① Model	Flat Cut List Price	Double Cut List Price
Lectern	22 [▲]	27	48	250	23	W2622LEC	\$2,447	\$2,692

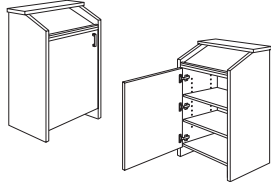

- two adjustable shelves
- four concealed non-locking casters
- non-locking
- standard door is hinged on left
- round grommet in bottom panel
- notches in adjustable shelves allow wires to pass through

Visual Board	48	48	3½	120	8	W4848VB	\$2,840	\$3,124
---------------------	----	----	----	-----	---	----------------	---------	---------

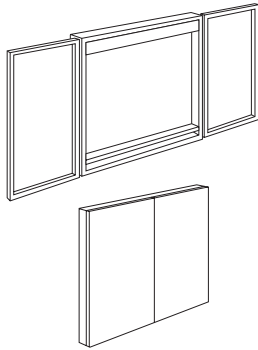

- tackboards on right and left; *Culp Montgomery Sterling* panel fabric standard
- marker board in center section
- four markers and eraser included
- locking not available

To Order, Specify:

- ① Model Number
- ② Wood Species - Cherry (CH1), Maple (MA1), Walnut (WA1) or Double Cut (see page 263)
- ③ Finish Color (see page 263)
- ④ Other Product Options

When ordering Quickship products, place a "Q" in front of model number.
Example: QVW3072DD

NOW!
Need it.
JSI Quickship

VISION - VENEER

Description	D	W	H	CTN WT	CU FT	① Model	Flat Cut List Price	Double Cut List Price
-------------	---	---	---	-----------	----------	---------	------------------------	--------------------------

Buffet Credenza	24	72	36	316	43	VV2472BSC	\$3,649	\$4,015
------------------------	----	----	----	-----	----	-----------	---------	---------

NOW!

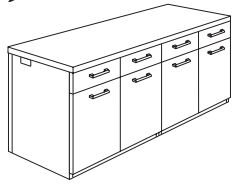

- four door credenza
- four box drawers above doors
- top edge profile on user side
- two end panel grommets with wire pass thru
- adjustable shelf in storage cabinets
- locking doors and drawers not available

Buffet Credenza - Flat Screen Support	24	72	36	316	43	VV2472BSCT	\$4,097	\$4,507
--	----	----	----	-----	----	------------	---------	---------

	20	72	36	291	31	VV2072BSCT	\$3,951	\$4,346
--	----	----	----	-----	----	------------	---------	---------

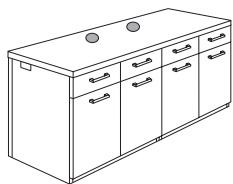

- four door credenza
- four box drawers above doors
- top edge profile on user side
- two end panel grommets with wire pass thru
- adjustable shelf in storage cabinets
- locking doors and drawers not available
- flat screen mounting grommets in top
- back panel includes cord exit grommets
- flat screen mounting frame sold separately, see below

Buffet Credenza	24	36	36	167	22	VV2436BSC	\$2,615	\$2,876
------------------------	----	----	----	-----	----	-----------	---------	---------

NOW!

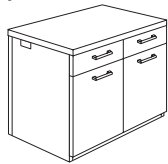

- two door credenza
- two box drawers above doors
- top edge profile on user side
- two end panel grommets with wire pass thru
- adjustable shelf in storage cabinet
- locking doors and drawers not available

Buffet Credenza - Flat Screen Support	24	36	36	167	22	VV2436BSCT	\$3,061	\$3,368
--	----	----	----	-----	----	------------	---------	---------

	20	36	36	155	16	VV2036BSCT	\$2,957	\$3,253
--	----	----	----	-----	----	------------	---------	---------

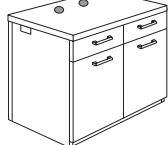

- two door credenza
- two box drawers above doors
- top edge profile on user side
- two end panel grommets with wire pass thru
- adjustable shelf in storage cabinet
- locking doors and drawers not available
- flat screen mounting grommets in top
- back panel includes cord exit grommets
- flat screen mounting frame sold separately, see below

Description	D	W	H	CTN WT	CU FT	① Model	List Price
-------------	---	---	---	-----------	----------	---------	------------

Flat Screen Mounting Frame	2	14	55	35	4	FSTV	\$1,236
-----------------------------------	---	----	----	----	---	------	---------

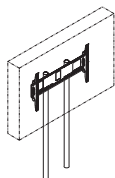

- round 2" tube frame with cable management to inside of credenza
- mounting bracket for TV provided (see page 322)
- available in black (B) or silver (S)
- TV not included
- coordinates with VL2472BSCT and VL2436BSCT

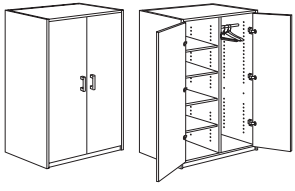
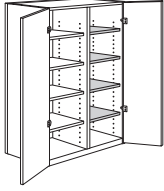
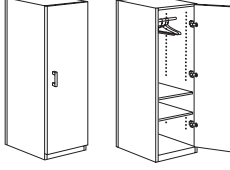
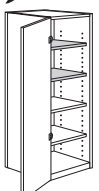
Description	D	W	H	CTN WT	CU FT	① Model	Flat Cut List Price	Double Cut List Price
72" h Wardrobe	24	36	72	226	43	VW2436-72W	\$2,997	\$3,297
NOW!	24	30	72	212	36	VW2430-72W	\$2,671	\$2,938
 <ul style="list-style-type: none"> · chrome hanging bar on right · one fixed shelf second from bottom on left · three adjustable shelves · locking doors available, specify and add \$210 list 	20	36	72	197	36	VW2036-72W	\$2,847	\$3,133
	20	30	72	185	31	VW2030-72W	\$2,537	\$2,791
	Hanging Bar to Shelves Conversion Kit							
 <ul style="list-style-type: none"> · four shelves · VW1824SK - for VW2436-84W and VW2436-72W · VW1524SK - for VW2430-84W and VW2430-72W · VW1820SK - for VW2036-84W and VW2036-72W · VW1520SK - for VW2030-84W and VW2030-72W 			¾	18	2	VW1824SK	\$634	\$698
			¾	15	2	VW1524SK	\$623	\$686
			¾	16	2	VW1820SK	\$602	\$663
			¾	14	2	VW1520SK	\$593	\$653
72" h Wardrobe	24	18	72	155	23	VW2418-72WR	\$2,343	\$2,578
NOW!	24	18	72	155	23	VW2418-72WL	\$2,343	\$2,578
 <p>right shown</p> <ul style="list-style-type: none"> · chrome hanging bar on right · one fixed shelf 29" from cabinet floor · one adjustable shelf · locking door available, specify and add \$105 list 	20	18	72	135	19	VW2018-72WR	\$2,161	\$2,378
	20	18	72	135	19	VW2018-72WL	\$2,161	\$2,378
Hanging Bar to Shelves Conversion Kit								
 <ul style="list-style-type: none"> · two shelves · VW1624SK - for VW2418-84WR/WL and VW2418-72WR/WL · VW1620SK - for VW2018-84WR/WL and VW2018-72WR/WL 			¾	16	2	VW1624SK	\$501	\$552
			¾	14	2	VW1620SK	\$477	\$525

To Order, Specify:

- ① Model Number
- ② Wood Species - Cherry (CH1), Maple (MA1), Walnut (WA1) or Double Cut (see page 263)
- ③ Finish Color (see page 263)
- ④ Edge Profile (see page 264)
- ⑤ Pull Style and Color (see page 264)
- ⑥ Grommet Color (see page 266) ▲
- ⑦ Power and Data Options (see page 322)
- ⑧ Other Product Options

When ordering Quickship products, place a "Q" in front of model number.
Example: QVW3072DD

NOW!
Need it.
JSI Quickship

Brogan Conference Product Information



BROGAN

Brogan Conference Product Information

Exterior Wood Materials

Exterior surfaces are made from the finest selected veneers to achieve clarity and consistency in the Brogan product line. To attain a pleasing, symmetrical pattern, all veneers in Brogan are book-matched. All exterior solid lumber is matched to coordinate with the veneer.

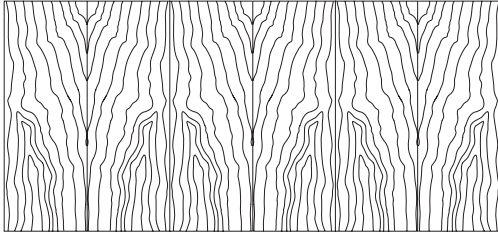

Book Matched Example

Alternating pieces of veneer are flipped over so they face each other like the pages within a book.

Brogan is available in flat cut cherry and walnut veneer. A wide range of wood stains have been formulated to enhance the beauty of the veneer.

Work Surface Construction

Tops are 5-ply balanced construction, 1 3/16" thick with solid matching hardwood edges. Tops are available in six edge profile.

Matching or coordinating high pressure laminate in a veneer grain can be applied to the top surface and is available at no additional charge.

Base Construction

Panels are joined together by mortise and tenon construction. In addition to mortise and tenon joint construction. Leveling glides are set into solid hardwood with t-nut inserts, which helps to prevent the leveling glide from tear out. Tops are secured to the bases with top fastening cleats screwed to the inside of the panels.

Drawers

The 9ply unidirectional hardwood sides of the drawer box are 7/16" thick assembled with English dovetail construction at each corner of the box. The drawer bottom panel is 1/4" thick fitting into a groove machined into the side of the box. Interiors are sanded and coated with clear U.V. finish to protect against shrinking, swelling or warping, and to provide a clean, smooth feel and appearance.

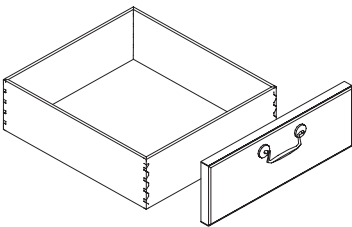

Drawer Suspension

The high quality black drawer suspensions carry a lifetime warranty. Slides feature steel ball bearings for longer life with cushioned in/out stops. File and box drawers have 100% full extension.

Finish - Stain/Colors

We offer a variety of wood stains and paint colors on Brogan. Please see the chart below. Samples are available upon request. Former finish names are listed in parentheses for reference.

CH1 Cherry <i>Flat Cut Veneer</i>	
AUT Autumn (<i>Autumn Cherry</i>)	EAR Earthy
BRL Barley	LGC Legacy (<i>Legacy Cherry</i>)
BBN Bourbon (<i>Natural Cherry</i>)	PRL Praline (<i>Vintage Cherry</i>)
BRG Brighton (<i>Brighton Cherry</i>)	SAF Saffron (<i>Medium Cherry</i>)
CLA Classic (<i>Classic Cherry</i>)	

WA1 Walnut <i>Flat Cut Veneer</i>	
AUB Auburn (<i>Windsor Mahogany</i>)	SIE Sienna
ESP Espresso	TOF Toffee
MCH Mocha	TRF Truffle
NTO Night Owl (<i>Vintage Walnut</i>)	

Protective Top Coat

DuraTex™ offers exceptional hardness along with abrasion and impact resistance, it has been formulated to eliminate hazardous and harmful gases that are normally associated with wood finish.

DuraTex™ Features

Safety - Significantly reduces hazardous formaldehyde emissions, which help improve the quality of the of the indoor air we breathe.

Quality - Developed to be tough and durable with special attention to appearance. The DuraTex™ finish preserves the natural beauty of wood.

Durability - Designed to meet a wide range of demanding performance and environmental standards to withstand even the highest wear and tear.

Brogan Conference Product Information

Product Modification

Laminate Tops

Worksurface only, no additional upcharge if coordinating wood grain laminate is specified. Contact Customer Service for any other laminate request. Listed below are finishes that have coordinating wood grain HPL laminates.

Cherry Finishes	Walnut Finishes
Autumn	Auburn
Barley	Mocha
Bourbon	Night Owl
Brighton	Sienna
Classic	Toffee
Legacy	Truffle
Praline	
Saffron	

Special Finishes

Special finishes can be requested by following the instruction in the general introduction section, page 3. There is a one time charge of \$289 list per order.

Finish Sheen Modification

Finish sheen can be modified on the worksurface tops. There is a 15% upcharge added to the list of each item.

Oak Veneer

Upon request veneer can be changed from the standard offering to oak flat cut veneer with an additional 40% upcharge to the list of each item.

Product Modification

Trim Molding

Brogan Trim molding is standard on all Brogan products.

Without molding or the Gala Trim molding can be specified at the time of order placement. *(diagram below show the molding options)*

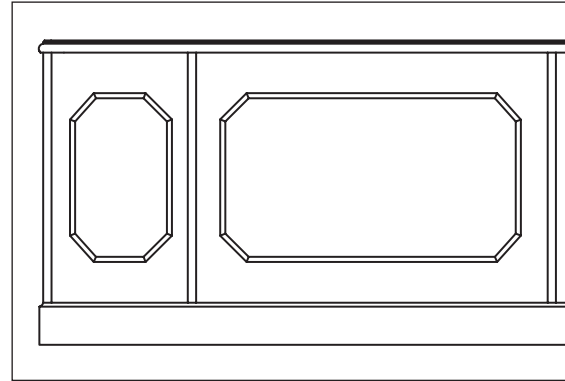

Brogan Trim
standard

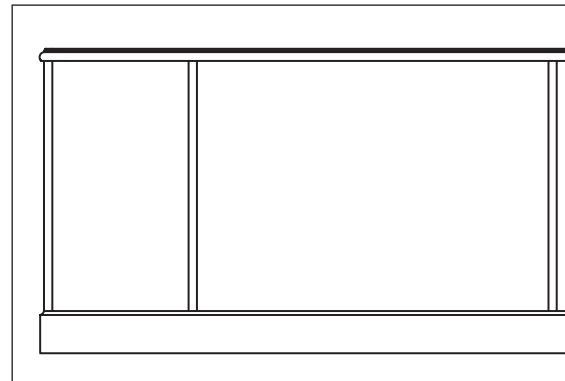

Base Molding Only (without trim)
optional at no charge

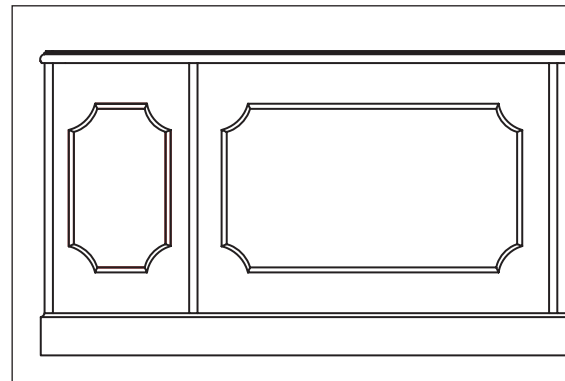

Gala Trim
optional with upcharge to list for each item
\$53 list per base

Brogan Conference Product Information

Edge and Hardware

Brogan offers a traditional edge profile and the Brogan drawer pull in antique brass or antique pewter finish.

Edge Profile

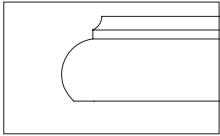

Federal Edge Profile (C3)
Accepts Laminate Top

Drawer Hardware

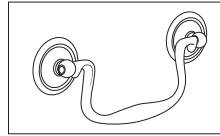

Brogan Hardware
Antique Brass (ANB)
Antique Pewter (ANP)

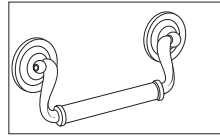

Gala Hardware▲
Antique Brass (ANB)
Antique Pewter (ANP)

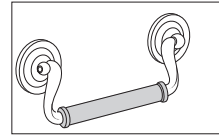

Gala Leather Wrapped Hardware▲
Antique Brass (ANB)
Antique Pewter (ANP)

Optional matching leather wrapped pulls available for desk with leather inlay or other coordinating units. Specify leather wrapped pulls, add \$39 list upcharge per pull. Indicate Antique Brass (ANB) or Antique Pewter (ANP) pull.

Top Shapes - size - base requirement - seating capacity

top sizes 108" through 192" are 2 pieces

top sizes above 192" are 3 pieces

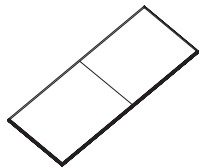

Size	Bases	Seats
264" x 54"	4 bases	seats 22
240" x 54"	4 bases	seats 20
216" x 54"	4 bases	seats 18
192" x 54"	3 bases	seats 16
264" x 48"	4 bases	seats 22
240" x 48"	4 bases	seats 20
216" x 48"	4 bases	seats 18
192" x 48"	3 bases	seats 16
168" x 48"	3 bases	seats 14
144" x 48"	3 bases	seats 12
120" x 48"	2 bases	seats 8
120" x 42"	2 bases	seats 8
108" x 42"	2 bases	seats 8
96" x 42"	2 bases	seats 8
72" x 36"	2 bases	seats 6



Size	Bases	Seats
264" x 54"	4 bases	seats 22
240" x 54"	4 bases	seats 20
216" x 54"	4 bases	seats 18
192" x 54"	3 bases	seats 16
264" x 48"	4 bases	seats 22
240" x 48"	4 bases	seats 20
216" x 48"	4 bases	seats 18
192" x 48"	3 bases	seats 16
168" x 48"	3 bases	seats 14
144" x 48"	3 bases	seats 12
120" x 48"	2 bases	seats 8
120" x 42"	2 bases	seats 8
108" x 42"	2 bases	seats 8
96" x 42"	2 bases	seats 8
72" x 36"	2 bases	seats 6

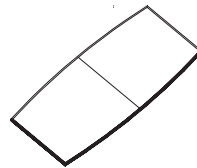

Size	Bases	Seats
264" x 54"	4 bases	seats 22
240" x 54"	4 bases	seats 20
216" x 54"	4 bases	seats 18
192" x 54"	3 bases	seats 16
264" x 48"	4 bases	seats 22
240" x 48"	4 bases	seats 20
216" x 48"	4 bases	seats 18
192" x 48"	3 bases	seats 16
168" x 48"	3 bases	seats 14
144" x 48"	3 bases	seats 12
120" x 48"	2 bases	seats 8
120" x 42"	2 bases	seats 8
108" x 42"	2 bases	seats 8
96" x 42"	2 bases	seats 8
72" x 36"	2 bases	seats 6



Size	Seats
60" dia.	Seats 6
54" dia.	Seats 6
48" dia.	Seats 4
42" dia.	Seats 4
36" dia.	Seats 4

*requires 1 base

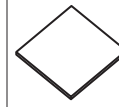

Size	Seats
60" sq.	seats 8
54" sq.	seats 6
48" sq.	seats 4
42" sq.	seats 4
36" sq.	seats 4
30" sq.	seats 4

*requires 1 base

Base (units with access panel in the base for wire management are available, order this feature with the appropriate model number.)

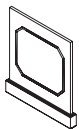

panel base
30" and 24" width

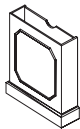

rectangle base
30" and 24" width



square base
24" width

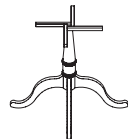

cabriole base
33" width

Grommet

Brogan Grommets

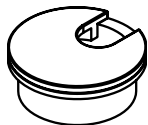

Work surface grommets can be specified work surfaces. The grommet location must be approved by JSI manufacturing; contact Customer Service.

Add \$79 to the list for each grommet.

Grommet color must be specified, select Antique Brass or Matte Black.▲ Lock cores will match grommet color.
Matte Black (MBK)
Antique Brass (ANB)

Brogan Conference Product Information

Finish and Product Reference Codes

Select	Code
--------	------

Veneer

Cherry Flat Cut	CH1
Walnut Flat Cut	WA1

Finish

Cherry Finishes

Autumn	AUT
Barley	BRL
Bourbon	BBN
Brighton	BRG
Classic	CLA
Earthy	EAR
Legacy	LGC
Praline	PRL
Saffron	SAF

Select	Code
--------	------

Finish *(continued)*

Walnut Finishes

Auburn	AUB
Espresso	ESP
Mocha	MCH
Night Owl	NTO
Sienna	SIE
Toffee	TOF
Truffle	TRF

Pull & Finishes Codes

Brogan Pull-Antique Brass	ANB
Brogan Pull-Pewter	PTR

Grommet Finish Codes

Antique Brass	ANB
Matte Black	MBK

Select	Code
--------	------

Laminate Coordinates

Cherry Wood Grain Patterns

Autumn	AUT
Barley	BRL
Bourbon	BBN
Brighton	BRG
Classic	CLA
Legacy	LGC
Praline	PRL
Saffron	SAF

Walnut Wood Grain Patterns

Auburn	AUB
Mocha	MCH
Night Owl	NTO
Sienna	SIE
Toffee	TOF
Truffle	TRF

Order Check List:

Specify:

- 1. Model Number
- 2. Finish
- 3. Wood Species - cherry - walnut
- 4. Top Options - standard veneer - laminate surface (see page 281)
- 5. Pull Selection **if applicable**
- 6. Other Product Options
- 7. Power and Data Accessories (*drawing showing location and orientation must accompany order*)
- 8. Side Mark Information (*i.e. room number, East Conference Room*)
- 9. Shipping Address (*contact name and phone number*)
- 10. Special Delivery Instructions (*i.e. call before delivery, deliver to job site*)

Description	D	W	H	Seating Capacity	CTN WT	CU FT	① Model	List Price
Conference Table	42	96	30	8			BG4296CTP	\$4,240

NOW!

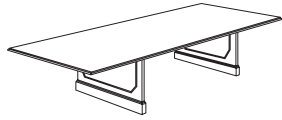

- ships KD in four cartons
- one piece top
- price reflects two bases
- includes BG0655SP stretcher panel

Consists of:								
					172	15	BG4296TT - Table Top	\$2,908
					59 ea.	4 ea.	BG2428PB - Panel Bases	\$1,332

Conference Table	36	72	30	6			BG3672CTP	\$3,201
------------------	----	----	----	---	--	--	------------------	----------------

NOW!

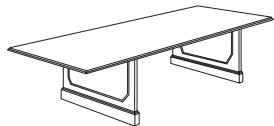

- ships KD in four cartons
- one piece top
- price reflects two bases
- includes BG0631SP stretcher panel

Consists of:								
					110	10	BG3672TT - Table Top	\$1,869
					59 ea.	4 ea.	BG2428PB - Panel Bases	\$1,332

BROGAN

Round Conference Table	48	48	30	4			BG48CTC	\$2,471
------------------------	----	----	----	---	--	--	----------------	----------------

NOW!

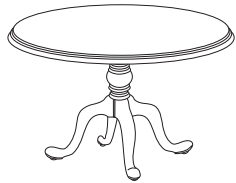

- ships KD in two cartons

Consists of:								
					73	7	BG48TT - Table Top	\$1,455
					30	16	BG33CB - Cabriole Base	\$1,016

Round Conference Table	42	42	30	4			BG42CTC	\$2,127
------------------------	----	----	----	---	--	--	----------------	----------------

NOW!

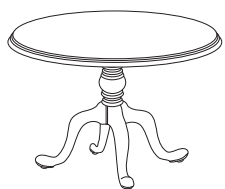

- ships KD in two cartons

Consists of:								
					56	5	BG42TT - Table Top	\$1,111
					30	16	BG33CB - Cabriole Base	\$1,016

Description	D	W	H	Seating Capacity	CTN WT	CU FT	1 Model	List Price
Conference Table	42	96	30	8			BG4296CTC	\$4,940

NOW!

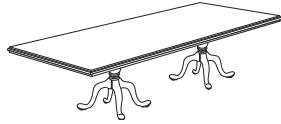

- ships KD in three cartons
- one piece top
- price reflects two bases

							Consists of:	
					172	15	BG4296TT - Table Top	\$2,908
					30 ea.	16 ea.	BG33CB - Cabriole Bases (2)	\$2,032

Conference Table	36	72	30	6			BG3672CTC	\$3,901
------------------	----	----	----	---	--	--	------------------	---------

NOW!



- ships KD in three cartons
- one piece top
- price reflects two bases

							Consists of:	
					110	10	BG3672TT - Table Top	\$1,869
					30 ea.	16 ea.	BG33CB - Cabriole Bases (2)	\$2,032

BROGAN

To Order, Specify:

- 1 Model Number
- 2 Wood Species
- 3 Finish Color
 - A Worksurface Finish
 - B. Chassis Finish
- 4 Power and Data Options (see page 322)
- 5 Other Product Options

When ordering Quickship products, place a "Q" in front of model number.
Example: QBG3072DD

NOW!
Need it.
JSI Quickship



Description	① Model	W	L	Seat Capacity	Top Pieces	Bases Required	CTN WT	CU FT	List Price
Rectangular Tops 	BG60264TT	60	264	24	3	4	673	57	\$12,280
	BG60240TT	60	240	22	3	4	613	51	\$11,163
	BG60216TT	60	216	20	3	4	552	48	\$10,050
	BG60192TT	60	192	18	2	3	490	42	\$8,931
	BG54264TT	54	264	22	3	4	609	52	\$10,234
	BG54240TT	54	240	20	3	4	554	50	\$9,303
	BG54216TT	54	216	18	3	4	498	43	\$8,375
	BG54192TT	54	192	16	2	3	441	38	\$7,443
	BG48264TT	48	264	22	3	4	548	47	\$9,099
	BG48240TT	48	240	20	3	4	498	43	\$8,272
	BG48216TT	48	216	18	3	4	447	38	\$7,443
	BG48192TT	48	192	16	2	3	396	33	\$6,618
	BG48168TT	48	168	14	2	3	346	30	\$5,791
	BG48144TT	48	144	12	2	3	296	28	\$4,964
	BG48120TT**	48	120	8	2	2	245	22	\$4,137
	BG4896TT	48	96	8	1	2	197	17	\$3,324
BG42120TT**	42	120	8	2	2	217	19	\$3,620	
BG42108TT	42	108	8	2	2	195	17	\$3,260	
BG4296TT	42	96	8	1	2	172	15	\$2,908	
BG4284TT	42	84	8	1	2	151	13	\$2,531	
BG3672TT	36	72	6	1	2	110	10	\$1,869	

**When ordering RECTANGLE or PANEL BASES - BG48120 and BG42120 require (3) panel bases and additional stretchers. Stretchers will be included as required.

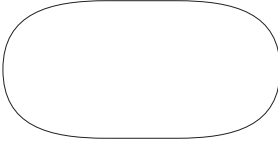
BROGAN

Racetrack Tops 	BG60264RT	60	264	24	3	4	646	57	\$14,511
	BG60240RT	60	240	22	3	4	589	51	\$13,193
	BG60216RT	60	216	20	3	4	530	48	\$11,875
	BG60192RT	60	192	18	2	3	471	42	\$10,556
	BG54264RT	54	264	22	3	4	586	52	\$12,093
	BG54240RT	54	240	20	3	4	530	50	\$10,994
	BG54216RT	54	216	18	3	4	474	43	\$9,896
	BG54192RT	54	192	16	2	3	417	38	\$8,796
	BG48264RT	48	264	22	3	4	529	47	\$10,750
	BG48240RT	48	240	20	3	4	479	43	\$9,774
	BG48216RT	48	216	18	3	4	428	38	\$8,796
	BG48192RT	48	192	16	2	3	377	33	\$7,819
	BG48168RT	48	168	14	2	3	327	30	\$6,760
	BG48144RT	48	144	12	2	3	277	28	\$5,866
	BG48120RT**	48	120	8	2	2	226	22	\$4,891
	BG4896RT	48	96	8	1	2	185	17	\$3,912
BG42120RT**	42	120	8	2	2	203	19	\$4,277	
BG42108RT	42	108	8	2	2	180	17	\$3,851	
BG4296RT	42	96	8	1	2	157	15	\$3,422	
BG4284RT	42	84	8	1	2	142	13	\$3,007	
BG3672RT	36	72	6	1	2	100	10	\$2,204	

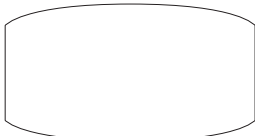
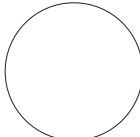
**When ordering RECTANGLE or PANEL BASES - BG48120 and BG42120 require (3) panel bases and additional stretchers. Stretchers will be included as required.

Description	① Model	W	L	Seat Capacity	Top Pieces	Bases Required	CTN WT	CU FT	List Price
Boat Shape Tops 	BG60264BT	60	264	24	3	4	646	57	\$14,511
	BG60240BT	60	240	22	3	4	589	51	\$13,193
	BG60216BT	60	216	20	3	4	530	48	\$11,875
	BG60192BT	60	192	18	2	3	471	42	\$10,556
	BG54264BT	54	264	22	3	4	586	52	\$12,093
	BG54240BT	54	240	20	3	4	530	50	\$10,994
	BG54216BT	54	216	18	3	4	474	43	\$9,896
	BG54192BT	54	192	16	2	3	417	38	\$8,796
Stretchers will be included as required.	BG48264BT	48	264	22	3	4	529	47	\$10,750
	BG48240BT	48	240	20	3	4	479	43	\$9,774
	BG48216BT	48	216	18	3	4	428	38	\$8,796
	BG48192BT	48	192	16	2	3	377	33	\$7,819
	BG48168BT	48	168	14	2	3	327	30	\$6,760
	BG48144BT	48	144	12	2	3	277	28	\$5,866
	BG48120BT**	48	120	8	2	2	226	22	\$4,891
	BG4896BT	48	96	8	1	2	185	17	\$3,912
	BG42120BT**	42	120	8	2	2	203	19	\$4,277
	BG42108BT	42	108	8	2	2	180	17	\$3,851
	BG4296BT	42	96	8	1	2	157	15	\$3,422
	BG4284BT	42	84	8	1	2	142	13	\$3,007
BG3672BT	36	72	6	1	2	100	10	\$2,204	
Round Tops 	BG60TT	60	N/A	6	1	1	112	10	\$2,461
	BG54TT	54	N/A	6	1	1	92	8	\$1,847
	BG48TT	48	N/A	4	1	1	73	7	\$1,455
	BG42TT	42	N/A	4	1	1	56	5	\$1,111
	BG36TT	36	N/A	3	1	1	42	4	\$978
Square Tops 	BG6060TT	60	60	8	1	1	154	10	\$2,254
	BG5454TT	54	54	6	1	1	125	8	\$1,706
	BG4848TT	48	48	4	1	1	99	7	\$1,347
	BG4242TT	42	42	4	1	1	77	5	\$1,032
	BG3636TT	36	36	4	1	1	56	4	\$931

BROGAN

To Order, Specify:

- ① Model Number
- ② Wood Species
- ③ Finish Color
- ④ Power and Data Options (see page 322)
- ⑤ Other Product Options

When ordering Quickship products, place a "Q" in front of model number.
 Example: QBG3072DD

NOW!
 Need it.
 JSI Quickship

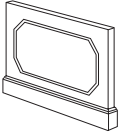
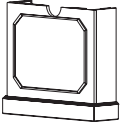
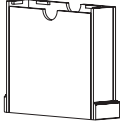
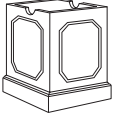
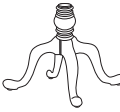
Description	D	W	H	CTN WT	CU FT	① Model	List Price
Panel Base 	2 5/16	36	28 3/4	88	6	BG3628PB	\$873
	2 5/16	30	28 3/4	73	5	BG3028PB · for use with 54" width top	\$770
	2 5/16	24	28 3/4	59	4	BG2428PB · for use with 36", 42", and 48" width top · (3) bases are required when ordering BG48120 or BG42120	\$666
Rectangle Base   side 1 side 2	7 5/8	36	28 3/4	74	7	BG3628PBA · access panel	\$1,232
	7 5/8	30	28 3/4	66	6	BG3028PBA · for use with 54" width top · access panel	\$1,176
	7 5/8	24	28 3/4	56	5	BG2428PBA · for use with 36", 42", and 48" width top · access panel	\$1,121
Square Base 	30	30	28 3/4	73	16	BG30SB	\$1,105
	30	30	28 3/4	73	16	BG30SBA · access panel	\$1,209
	24	24	28 3/4	74	12	BG24SB · for use with 54" and 60" width top	\$1,000
	24	24	28 3/4	74	12	BG24SBA · for use with 54" and 60" width top · access panel	\$1,108
	18	18	28 3/4	45	7	BG18SB · for use with 36", 42" and 48" width top	\$895
	18	18	28 3/4	45	7	BG18SBA · for use with 36", 42" and 48" width top · access panel	\$1,003
Cabriole Base 	33	33	28 3/4	30	16	BG33CB · for use with 36", 42" and 48" width top	\$1,016

BROGAN

Description	D	W	H	CTN WT	CU FT	① Model	List Price
Conference Lectern	23	27	48	250	23	BG2723LEC	\$2,577

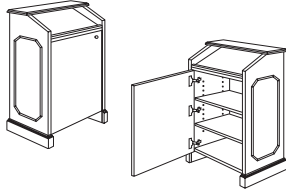

- two adjustable shelves
- four concealed, locking casters
- door is non-locking
- standard door is hinged on left
- round grommet in bottom panel
- notches in adjustable shelves allow wires to pass through

Visual Board	3½	48	48	125	8	BG4848VB	\$3,105
--------------	----	----	----	-----	---	----------	---------

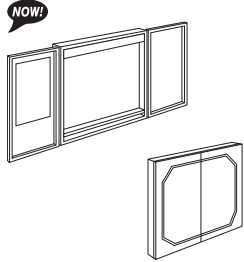

- corkboard on left and right doors; paper pad on left only
- marker board in center
- four markers and eraser included
- locking not available

Buffet Credenza	24	72	36	330	43	BG2472BSC	\$4,576
-----------------	----	----	----	-----	----	-----------	---------

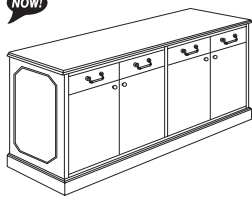

- four door credenza
- four box drawers above doors
- locking not available
- adjustable shelf in storage cabinet

Buffet Credenza - Flat Screen Support	24	72	36	330	43	BG2472BSCT	\$4,949
---------------------------------------	----	----	----	-----	----	------------	---------

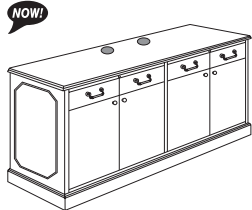

- four door credenza
- four box drawers above doors
- locking not available
- adjustable shelf in storage cabinet
- flat screen mounting grommets in top
- back panel includes cord exit grommets

Flat Screen Mounting Frame	2	14	55	35	4	FSTV	\$1,236
----------------------------	---	----	----	----	---	------	---------

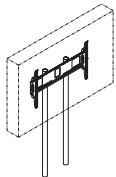

- round 2" tube frame with cable management to inside of credenza
- mounting bracket for TV provided (see page 322)
- available in black (B) or silver (S)
- TV not included
- coordinates with BG2472BSCT

To Order, Specify:

- ① Model Number
- ② Wood Species
- ③ Finish Color
- ④ Hardware Color - Antique Brass or Pewter
- ⑤ Power and Data Options (see page 322)
- ⑥ Other Product Options

When ordering Quickship products, place a "Q" in front of model number.
Example: QBG3072DD

NOW!
Need it.
JSI Quickship

Description	D	W	H	CTN WT	CU FT	① Model	List Price
72" h File/File Lateral Storage Cabinet	24	36	72	360	43	BG3672SWLF	\$4,131

NOW!

- two adjustable shelves
- locking doors available; specify and add \$105 list
- file/file lateral
- pedestal locking

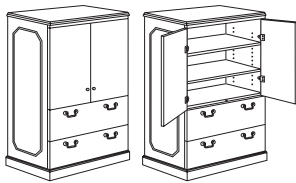

72" h Wardrobe	24	34 5/8	72	360	43	BG3672W	\$2,952
----------------	----	--------	----	-----	----	---------	---------

NOW!

- chrome hanging bar on right
- shelves on left (second from bottom fixed)
- locking doors available; specify and add \$210 list

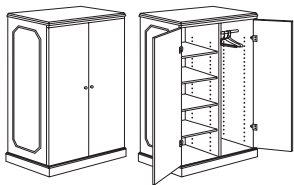

Hanging Bar to Shelves Conversion Kit			3/4	56	2	BG1824SK	\$634
--	--	--	-----	----	---	----------	-------

NOW!

- four shelves
- for 36" wide wardrobe

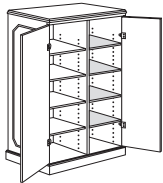

72" h File/File Storage Wardrobe	24	23 5/8	72	340	30	BG2472SWR	\$2,863
	24	23 5/8	72	340	30	BG2472SWL	\$2,863

NOW!

- chrome hanging bar
- two adjustable shelves
- bottom shelf fixed
- file/file pedestal
- locking not available

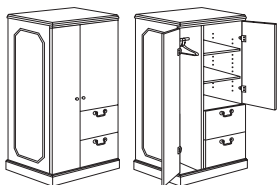

left shown

To Order, Specify:

- ① Model Number
- ② Wood Species
- ③ Finish Color
- ④ Pull Style and Color (see page 282) ▲
- ⑤ Power and Data Options (see page 322)
- ⑥ Other Product Options

When ordering Quickship products, place a "Q" in front of model number.
Example: QBG3072DD

NOW!

Need it.
JSI Quickship

Walden Conference Product Information



WALDEN

Walden Conference Product Information

Exterior Wood Materials

Exterior surfaces are made from the finest selected veneers to achieve clarity and consistency in the Walden product line. To attain a pleasing, symmetrical pattern, all veneers in Walden are book-matched. All exterior solid lumber is matched to coordinate with the veneer.

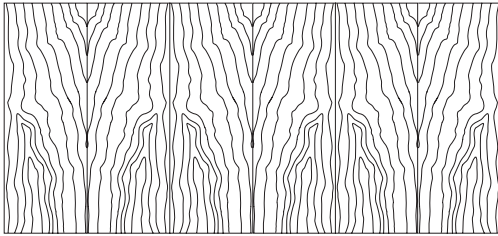

Book Matched Example

Alternating pieces of veneer are flipped over so they face each other like the pages within a book.

Walden is available in flat cut cherry veneer and walnut veneer. A wide range of wood stains have been formulated to enhance the beauty of the veneer.

Work Surface Construction

Tops are 3-ply balanced construction, 1 3/16" thick with solid matching hardwood edges. Tops are available in federal edge style profile.

Matching or coordinating high pressure laminate in a veneer grain can be applied to the top surface and is available at no additional charge.

Base Construction

Panels are joined together by mortise and tenon construction. In addition to mortise and tenon joint construction. Leveling glides are set into solid hardwood with t-nut inserts, which helps to prevent the leveling glide from tear out. Tops are secured to the bases with top fastening cleats screwed to the inside of the panels.

Drawers

The standard Baltic Birch drawer is constructed with 1/2" thick high quality Baltic Birch plywood with a durable finish. This five sided drawer box features fully glued dovetail construction ensuring a solid, warp resistant drawer box.

Veneered bottoms are framed into grooves on four sides. Bottoms are then glued, stapled, and reinforced with a continuous band of glue.

The optional V-fold drawer interior is a 1/2" durable, miter-fold drawer system. The V-fold vinyl wrapped drawer sides form a mitered box. The box is glued and doweled, the drawer fronts attached to the box.

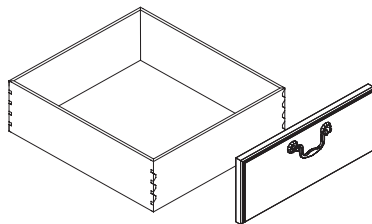

Drawer Suspension

The high quality black drawer suspensions carry a lifetime warranty. Slides feature steel ball bearings for longer life with cushioned in/out stops. File and box drawers have 100% full extension.

Finish - Stain/Colors

We offer a variety of wood stains and paint colors on Walden. Please see the chart below. Samples are available upon request. Former finish names are listed in parentheses for reference.

CH1 Cherry Flat Cut Veneer	
AUT Autumn (Autumn Cherry)	EAR Earthy
BRL Barley	LGC Legacy (Legacy Cherry)
BBN Bourbon (Natural Cherry)	PRL Praline (Vintage Cherry)
BRG Brighton (Brighton Cherry)	SAF Saffron (Medium Cherry)
CLA Classic (Classic Cherry)	

WA1 Walnut Flat Cut Veneer	
AUB Auburn (Windsor Mahogany)	SIE Sienna
ESP Espresso	TOF Toffee
MCH Mocha	TRF Truffle
NTO Night Owl (Vintage Walnut)	

Protective Top Coat

DuraTex™ offers exceptional hardness along with abrasion and impact resistance, it has been formulated to eliminate hazardous and harmful gases that are normally associated with wood finish.

DuraTex™ Features

Safety - Significantly reduces hazardous formaldehyde emissions, which help improve the quality of the of the indoor air we breathe.

Quality - Developed to be tough and durable with special attention to appearance. The DuraTex™ finish preserves the natural beauty of wood.

Durability - Designed to meet a wide range of demanding performance and environmental standards to withstand even the highest wear and tear.

Walden Conference Product Information

Product Modification

Laminate Tops

Worksurface only, no additional upcharge if coordinating wood grain laminate is specified. Contact Customer Service for any other laminate request. Listed below are finishes that have coordinating wood grain HPL laminates.

Cherry Finishes

Autumn
Barley
Bourbon
Brighton
Classic
Legacy
Praline
Saffron

Walnut Finishes

Auburn
Mocha
Night Owl
Sienna
Toffee
Truffle

Special Finishes

Special finishes can be requested by following the instruction in the general introduction section, page 3. There is a one time charge of \$289 list per order.

Sheen Modification ▲

Finish Sheen can be modified on the worksurface tops. There is a 15% upcharge added to the list of each item.

Product Modification

Trim Molding

Walden Trim molding is an option on all Walden products.

Walden trim molding (WDM) or without molding (WOM) can be specified at the time of order placement. Use the appropriate pricing column.

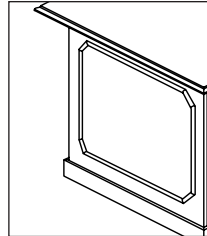

Walden Molding (WDM)

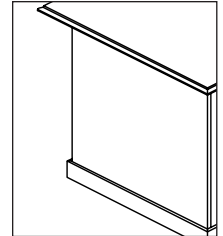

Base Molding Only (WOM)

Walden Conference Product Information

Edge and Hardware

Walden offers a traditional edge profile and the Walden drawer pull in antique brass or pewter finish.

Edge Profile

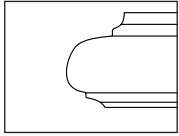

Federal Edge Profile
Accepts Laminate Top

Drawer Hardware

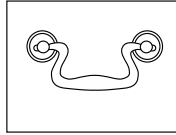

Walden Hardware (PJM6)
Antique Brass (ANB)
Pewter (PTR)

Grommet

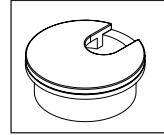

2" Dia. Antique Brass (G3A)
2" Dia. Black (G3B)

add \$79 to list price for each grommet
for electrical and data accessories see
page 322

Top Shapes - size - base requirement - seating capacity top sizes 144" through 120" are 2 pieces

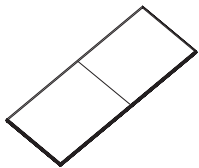

rectangular
144" x 60" 3 bases seats 14
144" x 48" 3 bases seats 12
120" x 48" 2 bases seats 8
96" x 48" 2 bases seats 8
72" x 36" 2 bases seats 6



racetrack
144" x 60" 3 bases seats 14
144" x 48" 3 bases seats 12
120" x 48" 2 bases seats 8
96" x 48" 2 bases seats 8
72" x 36" 2 bases seats 6

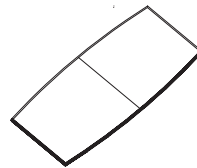

boat
144" x 48" 3 bases seats 12
120" x 48" 2 bases seats 8
96" x 48" 2 bases seats 8
72" x 36" 2 bases seats 6



round*
60" dia. Seats 6
54" dia. Seats 6
48" dia. Seats 4
42" dia. Seats 4
36" dia. Seats 4

*requires 1 base

Traditional Bases for Walden

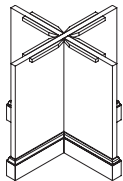

X base
25" width
29" width

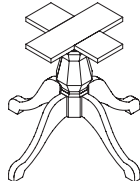

pedestal base
31" dia. span

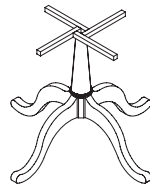

pedestal base
38" dia. span

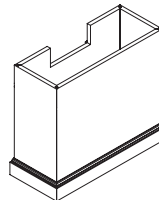

rectangular base
24" x 12"
30" x 12"
(access door models availability)
available with Walden molding options

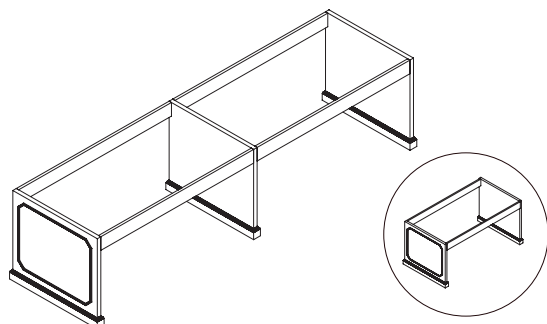
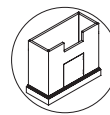

panel base assembly (panels 1/4" thick)

base sizes	top sizes
114" x 43" width	144" x 60"
114" x 31" width	144" x 48"
90" x 31" width	120" x 48"
72" x 31" width	96" x 48"
48" x 25" width	72" x 36"

bases 114" and longer requires middle panel
available with Walden molding options

Walden Conference Product Information

Finish and Product Reference Codes

Select	Code	Select	Code	Select	Code
Veneer		Finish <i>(continued)</i>		Laminate Coordinates	
Cherry Flat Cut	CH1	Walnut Finishes		Cherry Wood Grain Patterns	
Walnut Flat Cut	WA1	Auburn	AUB	Autumn	AUT
		Espresso	ESP	Barley	BRL
		Mocha	MCH	Bourbon	BBN
		Night Owl	NTO	Brighton	BRG
		Sienna	SIE	Classic	CLA
		Toffee	TOF	Legacy	LGC
		Truffle	TRF	Praline	PRL
				Saffron	SAF
Finish		Pull & Finishes Codes		Walnut Wood Grain Patterns	
Cherry Finishes		Walden Pull-Antique Brass	ANB	Auburn	AUB
Autumn	AUT	Walden Pull-Pewter	PTR	Mocha	MCH
Barley	BRL			Night Owl	NTO
Bourbon	BBN	Grommet Codes		Sienna	SIE
Brighton	BRG	2" dia. Antique Brass	G3A	Toffee	TOF
Classic	CLA	2" dia. Black	G3B	Truffle	TRF
Earthy	EAR				
Legacy	LGC				
Praline	PRL				
Saffron	SAF				

Order Check List:

Specify:

- 1. Model Number
- 2. Finish
- 3. Wood Species - cherry - walnut
- 4. Top Options - standard veneer - laminate surface (see page 293)
- 5. Pull Selection **if applicable**
- 6. Other Product Options
- 7. Power and Data Accessories (*drawing showing location and orientation must accompany order*)
- 8. Side Mark Information (*i.e. room number, East Conference Room*)
- 9. Shipping Address (*contact name and phone number*)
- 10. Special Delivery Instructions (*i.e. call before delivery, deliver to job site*)

Description	D	W	H	CTN WT	CU FT	① Model	Without Molding (WOM)	Walden Molding (WDM)
-------------	---	---	---	-----------	----------	---------	--------------------------	-------------------------

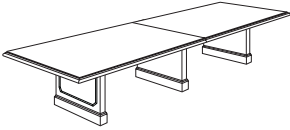
 <ul style="list-style-type: none"> · top shaped all sides · solid hardwood rims · top is two sections · ¾" h apron · base: GP8NPT1-31114 · flat cut, book-matched vertical veneers · panels are 1 ¼" thick · horizontal rail is 4 ¼" h · adjustable glides · seats 10 	48	144	29	361	51	WN8JRP4-48144	\$8,415	\$8,755
--	----	-----	----	-----	----	---------------	---------	---------

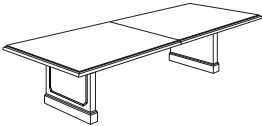
 <ul style="list-style-type: none"> · top shaped all sides · solid hardwood rims · top is two sections · ¾" h apron · base: GP8NPT1-3190 · flat cut, book-matched vertical veneers · panels are 1 ¼" thick · horizontal rail is 4 ¼" h · adjustable glides · seats 8 	48	120	29	283	24	WN8JRP4-48120	\$7,359	\$7,699
--	----	-----	----	-----	----	---------------	---------	---------

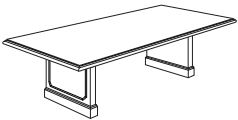
 <ul style="list-style-type: none"> · top shaped all sides · solid hardwood rims · ¾" h apron · base: GP8NPT1-3172 · flat cut, book-matched vertical veneers · panels are 1 ¼" thick · horizontal rail is 4 ¼" h · adjustable glides · seats 6 to 8 	48	96	29	245	18	WN8JRP4-4896	\$6,152	\$6,494
--	----	----	----	-----	----	--------------	---------	---------

WALDEN

Description	D	W	H	CTN WT	CU FT	① Model	Without Molding (WOM)	Walden Molding (WDM)
Boat Shaped Table	48	144	29	369	28	WN8JBP4-48144	\$9,004	\$9,345

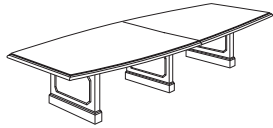

- top shaped all sides
- solid hardwood rims
- top is two sections
- 3/4" h apron
- base: GP8NPT1-31114
- flat cut, book-matched vertical veneers
- panels are 1 1/4" thick
- horizontal rail is 4 1/4" h
- adjustable glides
- top size: 38/48" d
- seats 10

Boat Shaped Table	48	120	29	283	24	WN8JBP4-48120	\$7,923	\$8,264
--------------------------	----	-----	----	-----	----	----------------------	----------------	----------------

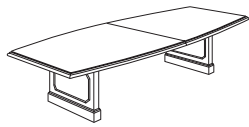

- top shaped all sides
- solid hardwood rims
- top is two sections
- 3/4" h apron
- base: GP8NPT1-3190
- flat cut, book-matched vertical veneers
- panels are 1 1/4" thick
- horizontal rail is 4 1/4" h
- adjustable glides
- top size: 38/48" d
- seats 8

Boat Shaped Table	48	96	29	245	18	WN8JBP4-4896	\$6,699	\$7,041
--------------------------	----	----	----	-----	----	---------------------	----------------	----------------

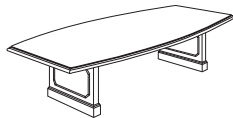

- top shaped all sides
- solid hardwood rims
- 3/4" h apron
- base: GP8NPT1-3172
- flat cut, book-matched vertical veneers
- panels are 1 1/4" thick
- horizontal rail is 4 1/4" h
- adjustable glides
- top size: 38/48" d
- seats 6 to 8

To Order, Specify:

- ① Model Number
- ② Wood Species - Cherry (CH1) or Walnut (WA1)
(see page 292)
- ③ Finish Color (see page 292)
- ④ Top Option (see page 294)
- ⑤ Product Modification (see page 293)
- ⑥ Power and Data Accessories (see page 322)

Description	D	W	H	CTN WT	CU FT	① Model	List Price
Round Table	48	48	29	108	46	WN8JDG4-0048	\$3,819

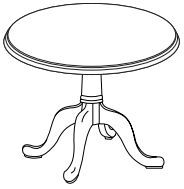

- top shaped all sides
- solid hardwood rims
- 1 5/8" h apron
- base: GP8NTR4-0038
- 30 1/2" span between legs
- adjustable glides
- seats 4

Round Table	42	42	29	82	16	WN8JDG4-0042	\$3,581
-------------	----	----	----	----	----	--------------	---------

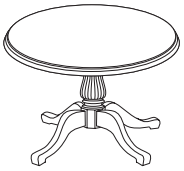

- top shaped all sides
- solid hardwood rims
- 1 5/8" h apron
- base: GP8NFG4-0031
- 30 1/2" span between legs
- adjustable glides
- seats 4

Description	D	W	H	CTN WT	CU FT	① Model	List Price
Rectangular Top 	60	144	1 ¼	330	30	WE8CTR1-60144	\$8,305
	48	144	1 ¼	280	28	WE8CTR1-48144	\$6,115
	48	120	1 ¼	250	22	WE8CTR1-48120	\$4,889
	48	96	1 ¼	220	20	WE8CTR1-4896	\$4,002
	36	72	1 ¼	190	10	WE8CTR1-3672	\$2,039

- top shaped all sides
- solid hardwood rims
- 120" and 144" tops are two sections

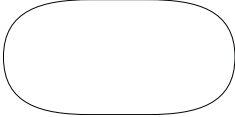
Racetrack Top 	60	144	1 ¼	320	30	WE8CTO1-60144	\$9,376
	48	144	1 ¼	368	28	WE8CTO1-48144	\$7,311
	48	120	1 ¼	148	22	WE8CTO1-48120	\$7,075
	48	96	1 ¼	220	20	WE8CTO1-4896	\$5,079
	36	72	1 ¼	92	10	WE8CTO1-3672	\$4,073

- top shaped all sides
- solid hardwood rims
- 1 5/8" h apron
- 120" and 144" tops are two sections

Boat Shaped Top 	48	144	1 ¼	178	28	WE8CTB1-48144	\$6,592
	48	120	1 ¼	148	22	WE8CTB1-48120	\$5,364
	48	96	1 ¼	221	20	WE8CTB1-4896	\$4,482
	36	72	1 ¼	87	10	WE8CTB1-3672	\$3,626

- top shaped all sides
- solid hardwood rims
- 3/4" h apron
- 120" and 144" tops are two sections
- 96" - 144" w top size: 38/48" d
- 72" w top size: 26/36" d

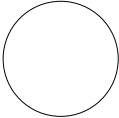
Round Top 	60	60	1 ¼	120	14	WE8CTD1-0060	\$4,220
	54	54	1 ¼	90	11	WE8CTD1-0054	\$3,690
	48	48	1 ¼	70	9	WE8CTD1-0048	\$3,089
	42	42	1 ¼	50	7	WE8CTD1-0042	\$2,846
	36	36	1 ¼	45	6	WE8CTD1-0036	\$2,724

- top shaped all sides
- solid hardwood rims

To Order, Specify:

- ① Model Number
- ② Wood Species - Cherry (CH1) or Walnut (WA1)
(see page 292)
- ③ Finish Color (see page 292)
- ④ Top Option (see page 294)
- ⑤ Product Modification (see page 293)
- ⑥ Power and Data Accessories (see page 322)

Description	D	W	H	CTN WT	CU FT	① Model	List Price
Traditional X Base	30 ¼	30 ¼	27 ⅞	46	12	GP8NCR4-2929	\$2,100
	22 ¾	22 ¾	27 ⅞	41	9	GP8NCR4-2525	\$2,100

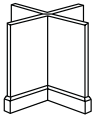

- hardwood solids and veneers
- panels are 1 ½" h thick
- base molding is 4 ¾"
- adjustable glides

Traditional Pedestal Base	30 ½	30 ½	27 ⅞	48	12	GP8NFG4-0031	\$920
---------------------------	------	------	------	----	----	--------------	-------



- hardwood solids
- 30 ½" leg span
- adjustable glides

Traditional Pedestal Base	37 ½	37 ½	27 ⅞	50	15	GP8NTR4-0038	\$2,237
---------------------------	------	------	------	----	----	--------------	---------

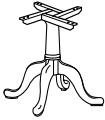

- hardwood solids
- 37 ½" leg span
- adjustable glides

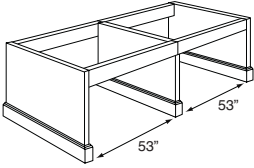
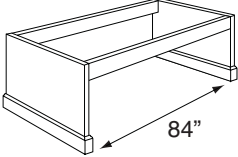
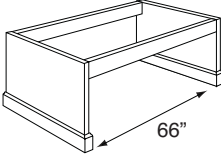
Description	D	W	H	CTN WT	CU FT	① Model	Without Molding (WOM)	Walden Molding (WDM)
144" Traditional Panel Base  <ul style="list-style-type: none"> walnut solids and veneers flat cut, book-matched vertical veneers molding only on outside end panels panels are 1 1/4" thick horizontal rail is 4 1/4" h GP8NPT1-43114 panel base with molding 43 1/4" w GP8NPT1-31114 panel with base molding 31 1/4" w adjustable glides 	43 1/4	113 3/4	27 7/8	105	15	GP8NPT1-43114	\$3,333	\$3,483
	31 1/4	113 3/4	27 7/8	95	13	GP8NPT1-31114	\$3,211	\$3,362
120" Traditional Panel Base  <ul style="list-style-type: none"> walnut solids and veneers flat cut, book-matched vertical veneers molding only on outside end panels panels are 1 1/4" thick horizontal rail is 4 1/4" h panel with base molding 31 1/4" w adjustable glides 	31 1/4	89 5/8	27 7/8	60	10	GP8NPT1-3190	\$2,947	\$3,097
	31 1/4	89 5/8	27 7/8	53	10	GP8NPT1-3172	\$2,552	\$2,702
96" Traditional Panel Base  <ul style="list-style-type: none"> walnut solids and veneers flat cut, book-matched vertical veneers molding only on outside end panels panels are 1 1/4" thick horizontal rail is 4 1/4" h panel with base molding 31 1/4" w adjustable glides 	25 1/4	47 5/8	27 7/8	47	9	GP8NPT1-2548	\$2,124	\$2,275
	25 1/4	47 5/8	27 7/8	47	9	GP8NPT1-2548	\$2,124	\$2,275

To Order, Specify:

- ① Model Number
- ② Wood Species - Cherry (CH1) or Walnut (WA1)
(see page 292)
- ③ Finish Color (see page 292)
- ④ Product Modification (see page 293)

Description	D	W	H	CTN WT	CU FT	① Model	Without Molding (WOM)	Windsor (WNM)	Wellington (WLM)	Westminster (WSM)
Traditional Rectangular Base- End Unit	12	30	27 ³ / ₈	95	8	GP8NRT1-1230	\$1,600	\$1,666	\$1,776	\$1,776
	12	24	27 ³ / ₈	67	6	GP8NRT1-1224	\$1,499	\$1,547	\$1,649	\$1,649

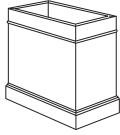

- hardwood solids and veneers
- flat cut, book-matched vertical veneers
- adjustable glides

Traditional Rectangular Base- Mid Unit	12	30	27 ³ / ₈	85	8	GP8NRTL-1230	\$1,667	\$1,736	\$1,843	\$1,843
	12	24	27 ³ / ₈	59	6	GP8NRTL-1224	\$1,561	\$1,609	\$1,711	\$1,711

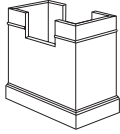

- hardwood solids and veneers
- flat cut, book-matched vertical veneers
- cut-out for wire pass-through
- adjustable glides

Traditional Rectangular Base- End Unit with Access Door	12	30	27 ³ / ₈	86	8	GP8NRTK-1230	\$1,940	\$2,008	\$2,116	\$2,116
	12	24	27 ³ / ₈	60	6	GP8NRTK-1224	\$1,814	\$1,862	\$1,964	\$1,964

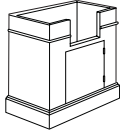

- hardwood solids and veneers
- flat cut, book-matched vertical veneers
- cut-out for wire pass-through
- adjustable glides
- access door opening: 12¹/₈" x 11⁷/₈"

Description	D	W	H	CTN WT	CU FT	① Model	List Price
Visual Board with Doors	5	48	48	135	8	GPOVIS1-0548	\$2,979

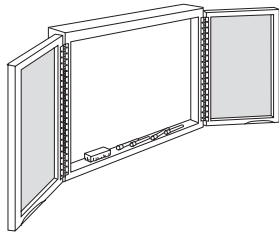

- two tackable cork panels
- porcelain magnetic non-glare writing surface
- mounted flip chart pad
- eraser and four markers
- finger grip doors
- wall mounting brackets

Meeting Room Credenza	24	71 3/8	36	330	44	MRC8072-36	\$6,925
-----------------------	----	--------	----	-----	----	------------	---------

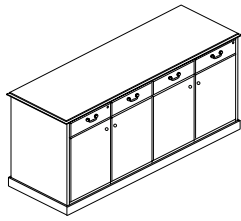

- four drawers
- top shaped all sides
- one adjustable shelf per double door
- locking doors available, specify and add \$200 list ▲

To Order, Specify:

- ① Model Number
- ② Wood Species - Cherry (CH1) or Walnut (WA1)
(see page 292)
- ③ Finish Color (see page 292)
- ④ Top Option (see page 294)
- ⑤ Pull Style and Color ▲
- ⑥ Product Modification (see page 293)

Wellington Conference Product Information



WELLINGTON

Wellington Conference Product Information

Exterior Wood Materials

Exterior surfaces are made from the finest selected veneers to achieve clarity and consistency in the Wellington product line. To attain a pleasing, symmetrical pattern, all veneers in Wellington are book-matched. All exterior solid lumber is matched to coordinate with the veneer.

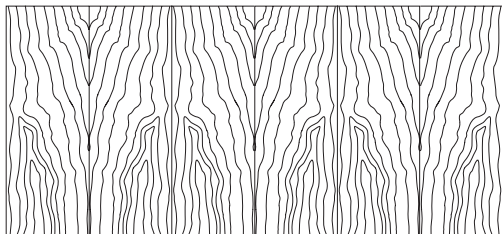

Book Matched Example

Alternating pieces of veneer are flipped over so they face each other like the pages within a book.

Wellington is available in flat cut cherry veneer and walnut veneer. A wide range of wood stains have been formulated to enhance the beauty of the veneer.

Work Surface Construction

Tops are 3-ply balanced construction, 1 3/16" thick with solid matching hardwood edges. Tops are available in federal edge style profile.

Matching or coordinating high pressure laminate in a veneer grain can be applied to the top surface and is available at no additional charge.

Base Construction

Panels are joined together by mortise and tenon construction. In addition to mortise and tenon joint construction. Leveling glides are set into solid hardwood with t-nut inserts, which helps to prevent the leveling glide from tear out. Tops are secured to the bases with top fastening cleats screwed to the inside of the panels.

Drawers

All drawer fronts are 5-ply construction with a hardwood core. Veneer grain runs in a vertical direction. Drawer sides and backs are solid wood with top edges of sides completely rounded. Drawers are joined at front using a French dovetail and the back by an English dovetail. Veneered bottoms are framed into grooves on four sides and heavily glue blocked. All drawer interiors are finished with special toner and covered with a clear coat. Drawer bottoms are sanded and hand-rubbed.

All drawer bottoms are glued, stapled and reinforced with hand-fitted glue blocks.

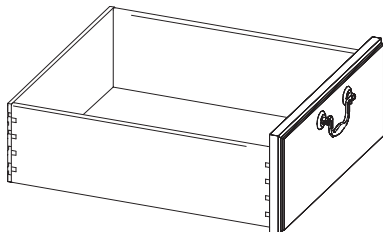

Drawer Suspension

The high quality black drawer suspensions carry a lifetime warranty. Slides feature steel ball bearings for longer life with cushioned in/out stops. File and box drawers have 100% full extension.

Locking

Locking is standard in all credenzas and modular units. Door locks are available as an option.

Units are shipped randomly keyed as standard. Key alike units are available upon request for no additional charges. Removable cores for in-field re-keying are standard.

Finish - Stain/Colors

We offer a variety of wood stains and paint colors on Waldon. Please see the chart below. Samples are available upon request. Former finish names are listed in parentheses for reference.

CH1 Cherry Flat Cut Veneer

AUT Autumn (<i>Autumn Cherry</i>)	EAR Earthy
BRL Barley	LGC Legacy (<i>Legacy Cherry</i>)
BBN Bourbon (<i>Natural Cherry</i>)	PRL Praline (<i>Vintage Cherry</i>)
BRG Brighton (<i>Brighton Cherry</i>)	SAF Saffron (<i>Medium Cherry</i>)
CLA Classic (<i>Classic Cherry</i>)	

WA1 Walnut Flat Cut Veneer

AUB Auburn (<i>Windsor Mahogany</i>)	SIE Sienna
ESP Espresso	TOF Toffee
MCH Mocha	TRF Truffle
NTO Night Owl (<i>Vintage Walnut</i>)	

Protective Top Coat

DuraTex™ offers exceptional hardness along with abrasion and impact resistance, it has been formulated to eliminate hazardous and harmful gases that are normally associated with wood finish.

DuraTex™ Features

Safety - Significantly reduces hazardous formaldehyde emissions, which help improve the quality of the of the indoor air we breathe.

Quality - Developed to be tough and durable with special attention to appearance. The DuraTex™ finish preserves the natural beauty of wood.

Durability - Designed to meet a wide range of demanding performance and environmental standards to withstand even the highest wear and tear.

Wellington Conference Product Information

Product Modification

Laminate Tops

Worksurface only, no additional upcharge if coordinating wood grain laminate is specified. Contact Customer Service for any other laminate request. Listed below are finishes that have coordinating wood grain HPL laminates.

Cherry Finishes

- Autumn*
- Barley*
- Bourbon*
- Brighton*
- Classic*
- Legacy*
- Praline*
- Saffron*

Walnut Finishes

- Auburn*
- Mocha*
- Night Owl*
- Sienna*
- Toffee*
- Truffle*

Special Finishes

Special finishes can be requested by following the instruction in the general introduction section, page 3. There is a one time charge of \$289 list per order.

Sheen Modification ▲

Finish Sheen can be modified on the worksurface tops. There is a 15% upcharge added to the list of each item.

Product Modification

Trim Molding

Wellington offers four different trim molding options:

- WLM Wellington
- WSM Westminster
- WNM Windsor
- WOM Without Molding

Tables and credenzas have molding on the side of the bases and panels, use the appropriate pricing column, when applicable.

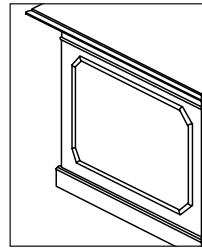

Wellington Molding
Use the **WLM** pricing column

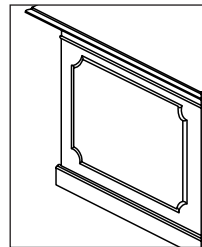

Westminster Molding
Use the **WSM** pricing column

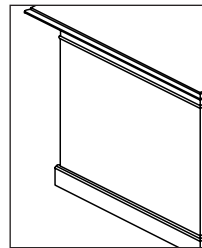

Windsor Molding
Use the **WNM** pricing column

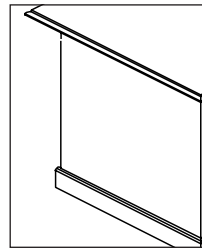

Without Molding
Use the **WOM** pricing column

Wellington Conference Product Information

Edge, Hardware and Grommet

Wellington offers a traditional edge profile and the Wellington drawer pull in antique brass or burnished brass.

Edge Profile

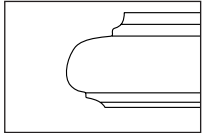

Federal Edge Profile
Accepts Laminate Top

Drawer Hardware

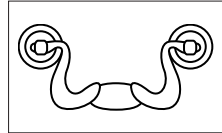

Wellington Hardware
Antique Brass (ANB)
Burnished Brass (BBR)

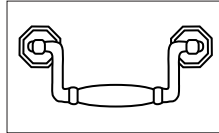

Windsor Hardware
Antique Brass (ANB)
Burnished Brass (BBR)

Grommet

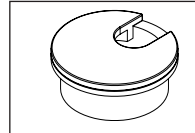

2" Dia. Antique Brass (G3C)
2" Dia. Burnish Brass (G3D)

add \$79 to list price for each grommet for electrical and data accessories see page 322

Top Shapes - size - base requirement - seating capacity top sizes 144" through 120" are 2 pieces

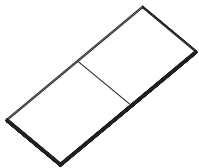

rectangular
144" x 60" 3 bases seats 14
144" x 48" 3 bases seats 12
120" x 48" 2 bases seats 8
96" x 48" 2 bases seats 8
72" x 36" 2 bases seats 6

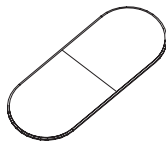

racetrack
144" x 60" 3 bases seats 14
144" x 48" 3 bases seats 12
120" x 48" 2 bases seats 8
96" x 48" 2 bases seats 8
72" x 36" 2 bases seats 6

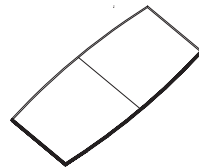

boat
144" x 48" 3 bases seats 12
120" x 48" 2 bases seats 8
96" x 48" 2 bases seats 8
72" x 36" 2 bases seats 6



round*
60" dia. Seats 6
54" dia. Seats 6
48" dia. Seats 4
42" dia. Seats 4
36" dia. Seats 4

*requires 1 base

Traditional Bases for Wellington

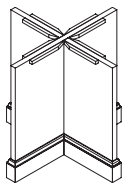

X base
25" width
29" width

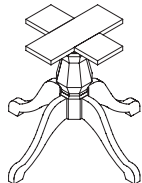

pedestal base
31" dia. span

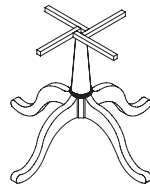

pedestal base
38" dia. span

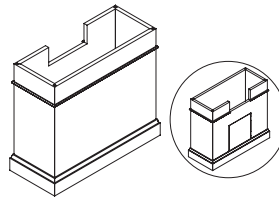

rectangular base
24" x 12"
30" x 12"
(access door models availability)
available with Wellington molding options
(diagram shows WNM molding)

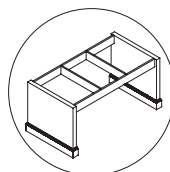
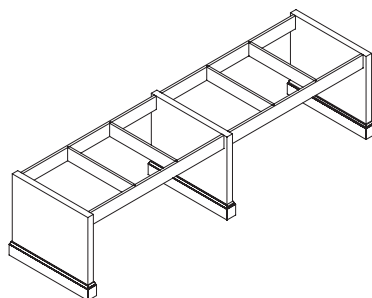

panel base assembly (panels 2 1/4" thick)

base sizes	top sizes
114" x 43" width	144" x 60"
114" x 31" width	144" x 48"
90" x 31" width	120" x 48"
72" x 31" width	96" x 48"
48" x 25" width	72" x 36"

bases 114" and longer requires middle panel
available with Wellington molding options (diagram shows WOM molding)

Wellington Conference Product Information

Finish and Product Reference Codes

Select	Code
--------	------

Veneer

Cherry Flat Cut	CH1
Walnut Flat Cut	WA1

Finish

Cherry Finishes

Autumn	AUT
Barley	BRL
Bourbon	BBN
Brighton	BRG
Classic	CLA
Earthy	EAR
Legacy	LGC
Praline	PRL
Saffron	SAF

Walnut Finishes

Auburn	AUB
Espresso	ESP
Mocha	MCH
Night Owl	NTO
Sienna	SIE
Toffee	TOF
Truffle	TRF

Select	Code
--------	------

Pull & Finishes Codes

Wellington - Antique Brass	ANB
Wellington - Burnished Brass	BBR
Windsor - Antique Brass	ANB
Windsor - Burnished Brass	BBR

Grommet Codes

2" dia. Antique Brass	G3C
2" dia. Burnished Brass	G3D

Wellington Molding Options

Wellington Molding	WLM
Westminster Molding	WSM
Windsor Molding	WNM
No Molding Trim	WOM

Select	Code
--------	------

Laminate Coordinates

Cherry Wood Grain Patterns

Autumn	AUT
Barley	BRL
Bourbon	BBN
Brighton	BRG
Classic	CLA
Legacy	LGC
Praline	PRL
Saffron	SAF

Walnut Wood Grain Patterns

Auburn	AUB
Mocha	MCH
Night Owl	NTO
Sienna	SIE
Toffee	TOF
Truffle	TRF

Order Check List:

Specify:

- 1. Model Number
- 2. Finish
- 3. Wood Species - cherry - walnut
- 4. Top Options - standard veneer - laminate surface (see page 307)
- 5. Pull Selection **if applicable**
- 6. Other Product Options - (such as molding)
- 7. Power and Data Accessories (drawing showing location and orientation must accompany order)
- 8. Side Mark Information (i.e. room number, East Conference Room)
- 9. Shipping Address (contact name and phone number)
- 10. Special Delivery Instructions (i.e. call before delivery, deliver to job site)

Description	D	W	H	CTN WT	CU FT	① Model	Without Molding (WOM)	Windsor (WNM)	Wellington (WLM)	Westminster (WSM)
-------------	---	---	---	-----------	----------	---------	-----------------------------	------------------	---------------------	----------------------

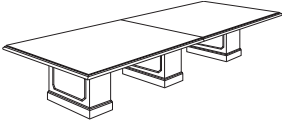
 <ul style="list-style-type: none"> · top shaped all sides · solid hardwood rims · top is two sections · ¾" h apron · base: (3) GP8NRT1-1230, 30" x 12" · hardwood solids and veneers · flat cut, book-matched vertical veneers · adjustable glides · seats 10 to 12 	60	144	29	434	41	WE8JRR4-60144	\$12,394	\$12,488	\$12,846	\$12,846
---	----	-----	----	-----	----	---------------	----------	----------	----------	----------

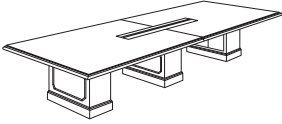
 <ul style="list-style-type: none"> · top shaped all sides · solid hardwood rims · top is two sections · ¾" h apron · includes a 30" EC power and data unit; see page 323 for more details · console with retractable doors · standard with silver pearl powder coat · brush stainless steel doors available; specify and add \$1,584 list · base: (2) GP8NRTK-1230, 30" x 12" · open wire access, top of panel · access door, 12 ½" x 11 ⅞", 6" from floor · (1) GP8NRTL-1230, 30" x 12" · open wire access, top of both sides · flat cut, book-matched vertical veneers · adjustable glides · seats 10 to 12 	60	144	29	434	42	WE8JRR4-60144	\$16,449	\$16,533	\$16,903	\$16,903
--	----	-----	----	-----	----	---------------	----------	----------	----------	----------

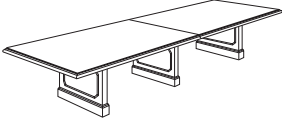
 <ul style="list-style-type: none"> · top shaped all sides · solid hardwood rims · top is two sections · ¾" h apron · panels are 2 ¼" thick · base: WE8NPT1-31114, 113 ¾" x 31 ¼" · flat cut, book-matched vertical veneers · horizontal rail is 4 ¼" h · adjustable glides · seats 10 	48	144	29	374	38	WE8JRP4-48144	\$10,533	\$10,714	\$11,121	\$11,121
--	----	-----	----	-----	----	---------------	----------	----------	----------	----------

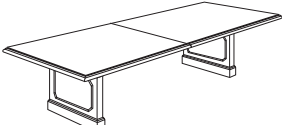
 <ul style="list-style-type: none"> · top shaped all sides · solid hardwood rims · top is two sections · ¾" h apron · panels are 2 ¼" thick · base: WE8NPT1-3190, 89 ⅝" x 31 ¼" · flat cut, book-matched vertical veneers · horizontal rail is 4 ¼" h · adjustable glides · seats 8 	48	120	29	283	24	WE8JRP4-48120	\$8,612	\$8,672	\$8,913	\$8,913
---	----	-----	----	-----	----	---------------	---------	---------	---------	---------

WELLINGTON

Description	D	W	H	CTN WT	CU FT	① Model	Without Molding (WOM)	Windsor (WNM)	Wellington (WLM)	Westminster (WSM)
Rectangular Table with Power Console	48	144	29	374	38	WE8JRRRC-48144	\$14,769	\$14,898	\$15,221	\$15,221
	48	120	29	252	18	WE8JRRRC-48120	\$12,678	\$12,807	\$13,130	\$13,130

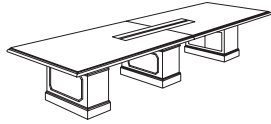

- top shaped all sides
- solid hardwood rims
- top is two sections
- ¾" h apron
- includes a 30" EC power and data unit; see page 323 for more details
- console with retractable doors
- standard with silver pearl powder coat
- brush stainless steel doors available; specify and add \$1,584 list
- base: (2) GP8NRTK-1224, 24" x 12"
- open wire access, top of panel
- access door, 12 ½" x 11 ⅞", 6" from floor
- (1) GPNRTL-1224, 24" x 12"
- open wire access, top of both sides
- flat cut, book-matched vertical veneers
- adjustable glides
- 144" seats 10
- 120" seats 8

Rectangular Table	48	96	29	323	37	WE8JRP4-4896	\$7,085	\$7,145	\$7,386	\$7,386
	36	72	29	200	14	WE8JRP4-3672	\$4,527	\$4,589	\$4,828	\$4,828

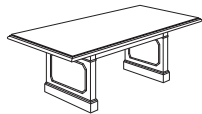

- top shaped all sides
- solid hardwood rims
- ¾" h apron
- panels are 2 ¼" thick
- 96" base: WE8NPT1-3172
- 72" base: WE8NPT1-2548
- flat cut, book-matched vertical veneers
- horizontal rail is 4 ¼" h
- adjustable glides
- 96" seats 6 to 8
- 72" seats 6

To Order, Specify:

- ① Model Number
- ② Wood Species - Cherry (CH1) or Walnut (WA1)
(see page 306)
- ③ Finish Color (see page 306)
- ④ Top Option (see page 308)
- ⑤ Product Modification (see page 307)
- ⑥ Power and Data Accessories (see page 322)

Description	D	W	H	CTN WT	CU FT	① Model	Without Molding (WOM)	Windsor (WNM)	Wellington (WLM)	Westminster (WSM)
-------------	---	---	---	-----------	----------	---------	-----------------------------	------------------	---------------------	----------------------

Boat Shaped Table	48	144	29	369	28	WE8JBP4-48144	\$11,096	\$11,191	\$11,549	\$11,549
--------------------------	----	-----	----	-----	----	----------------------	----------	----------	----------	----------

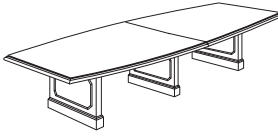

- top shaped all sides
- solid hardwood rims
- top is two sections
- ¾" h apron
- base: WE8NPT1-31114
- panels are 2 ¼" thick
- flat cut, book-matched vertical veneers
- horizontal rail is 4 ¼" h
- adjustable glides
- seats 10

Boat Shaped Table	48	120	29	283	24	WE8JBP4-48120	\$9,130	\$9,190	\$9,433	\$9,433
--------------------------	----	-----	----	-----	----	----------------------	---------	---------	---------	---------

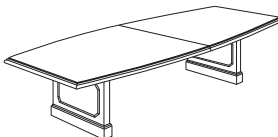

- top shaped all sides
- solid hardwood rims
- top is two sections
- ¾" h apron
- base: WE8NPT1-3190
- panels are 2 ¼" thick
- flat cut, book-matched vertical veneers
- horizontal rail is 4 ¼" h
- adjustable glides
- seats 8

Boat Shaped Table with Power	48	144	29	374	38	WE8JBRC-48144	\$15,332	\$15,377	\$15,650	\$15,650
	48	120	29	283	24	WE8JBRC-48120	\$13,197	\$13,327	\$13,652	\$13,652

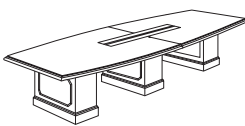

- top shaped all sides
- solid hardwood rims
- top is two sections
- ¾" h apron
- includes a 30" EC power and data unit; see page 323 for more details
- console with retractable doors
- standard with silver pearl powder coat
- brush stainless steel doors available; specify and add \$1,584 list
- base: (2) GP8NRTK-1224, 24" x 12"
- open wire access, top of panel
- access door, 12 ½" x 11 ⅞" , 6" from floor
- (1) GP8NRTL-1224, 24" x 12"
- open wire access, top of both sides
- flat cut, book-matched vertical veneers
- adjustable glides
- 144" seats 10
- 120" seats 8

Boat Shaped Table	48	96	29			WE8JBP4-4896	\$7,554	\$7,613	\$7,856	\$7,856
--------------------------	----	----	----	--	--	---------------------	---------	---------	---------	---------

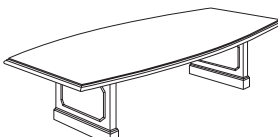

- top shaped all sides
- solid hardwood rims
- ¾" h apron
- panels are 2 ¼" thick
- base: WE8NPT1-3172
- flat cut, book-matched vertical veneers
- horizontal rail is 4 ¼" h
- adjustable glides
- seats 6 to 8

WELLINGTON

Description	D	W	H	CTN WT	CU FT	① Model	List Price
Racetrack Top Table	48	144	29	340	105	WE8JOT4-48144	\$12,686
	48	120	29	252	12	WE8JOT4-48120	\$11,443

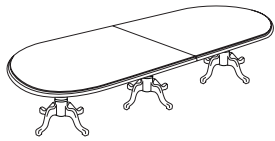

- shaped top
- solid hardwood rims
- top is two sections
- 1 5/8" h apron
- base: (3) GP8NTR4-0038
- 37 1/2 " span between legs
- adjustable glides
- 144" seats 10
- 120" seats 8

Racetrack Top Table	48	96	29	221	70	WE8JOT4-4896	\$7,919
----------------------------	----	----	----	-----	----	---------------------	----------------

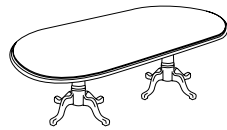

- shaped top
- solid hardwood rims
- 1 5/8" h apron
- base: (2) GP8NTR4-0038
- 37 1/2 " span between legs
- adjustable glides
- seats 6 to 8

Round Table	48	48	29	87	20	WE8JDT4-0048	\$4,918
	42	42	29	87	21	WE8JDT4-0042	\$4,679



- shaped top
- solid hardwood rims
- 1 5/8" h apron
- base: GP8NTR4-0038
- 37 1/2 " span between legs
- adjustable glides
- seats 4

Round Table	36	36	29	67	8	WE8JDG4-0036	\$3,153
--------------------	----	----	----	----	---	---------------------	----------------



- shaped top
- solid hardwood rims
- 1 5/8" h apron
- base: GP8NFG4-0031
- 30 1/2 " span between legs
- adjustable glides
- seats 3

To Order, Specify:

- ① Model Number
- ② Wood Species - Cherry (CH1) or Walnut (WA1)
(see page 306)
- ③ Finish Color (see page 306)
- ④ Top Option (see page 308)
- ⑤ Product Modification (see page 307)
- ⑥ Power and Data Accessories (see page 322)

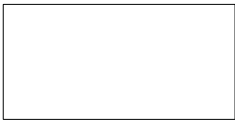
Description	D	W	H	CTN WT	CU FT	① Model	List Price
Rectangular Top 	60	144	1 ¼	330	30	WE8CTR1-60144	\$8,305
	48	144	1 ¼	280	28	WE8CTR1-48144	\$6,115
	48	120	1 ¼	250	22	WE8CTR1-48120	\$4,889
	48	96	1 ¼	220	20	WE8CTR1-4896	\$4,002
	36	72	1 ¼	190	10	WE8CTR1-3672	\$2,039

- top shaped all sides
- solid hardwood rims
- 120" and 144" tops are two sections

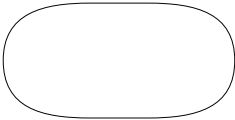
Description	D	W	H	CTN WT	CU FT	① Model	List Price
Racetrack Top 	60	144	1 ¼	320	30	WE8CTO1-60144	\$9,376
	48	144	1 ¼	368	28	WE8CTO1-48144	\$7,311
	48	120	1 ¼	148	22	WE8CTO1-48120	\$7,075
	48	96	1 ¼	220	20	WE8CTO1-4896	\$5,079
	36	72	1 ¼	92	10	WE8CTO1-3672	\$4,073

- top shaped all sides
- solid hardwood rims
- 1 5/8" h apron
- 120" and 144" tops are two sections

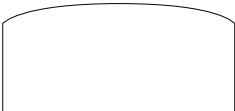
Description	D	W	H	CTN WT	CU FT	① Model	List Price
Boat Shaped Top 	48	144	1 ¼	178	28	WE8CTB1-48144	\$6,592
	48	120	1 ¼	148	22	WE8CTB1-48120	\$5,364
	48	96	1 ¼	221	20	WE8CTB1-4896	\$4,482
	36	72	1 ¼	87	10	WE8CTB1-3672	\$3,626

- top shaped all sides
- solid hardwood rims
- ¾" h apron
- 120" and 144" tops are two sections
- 96" - 144" w top size: 38/48" d
- 72" w top size: 26/36" d

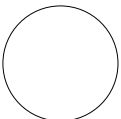
Description	D	W	H	CTN WT	CU FT	① Model	List Price
Round Top 	60	60	1 ¼	120	14	WE8CTD1-0060	\$4,220
	54	54	1 ¼	90	11	WE8CTD1-0054	\$3,690
	48	48	1 ¼	70	9	WE8CTD1-0048	\$3,089
	42	42	1 ¼	50	7	WE8CTD1-0042	\$2,846
	36	36	1 ¼	45	6	WE8CTD1-0036	\$2,724

- top shaped all sides
- solid hardwood rims

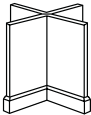
Description	D	W	H	CTN WT	CU FT	① Model	List Price
	30 ¼	30 ¼	27 ⅞	46	12	GP8NCR4-2929	\$2,100
	22 ¾	22 ¾	27 ⅞	40	10	GP8NCR4-2525	\$2,100

- hardwood solids
- panels are 1 ½" h thick
- base molding is 4 ¾"
- adjustable glides

	30 ½	30 ½	27 ⅞	48	12	GP8NFG4-0031	\$920
---	------	------	------	----	----	--------------	-------

- hardwood solids
- 30 ½" leg span
- adjustable glides

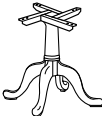
	37 ½	37 ½	27 ⅞	50	15	GP8NTR4-0038	\$2,237
---	------	------	------	----	----	--------------	---------

- hardwood solids
- 37 ½" leg span
- adjustable glides

To Order, Specify:

- ① Model Number
- ② Wood Species - Cherry (CH1) or Walnut (WA1)
(see page 306)
- ③ Finish Color (see page 306)
- ④ Top Option (see page 308)
- ⑤ Product Modification (see page 307)
- ⑥ Power and Data Accessories (see page 322)

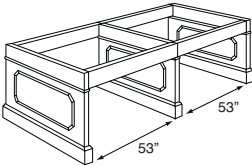
Description	D	W	H	CTN WT	CU FT	① Model	Without Molding (WOM)	Windsor (WNM)	Wellington (WLM)	Westminster (WSM)
144" Traditional Panel Base  wellington molding shown	43 ¼	113 ¾	27 ⅞	105	15	WE8NPT1-43114	\$5,588	\$5,693	\$6,086	\$6,086
	31 ¼	113 ¾	27 ⅞	95	13	WE8NPT1-31114	\$5,328	\$5,429	\$5,880	\$5,880

- hardwood solids and veneers
- flat cut, book-matched vertical veneers
- panels are 2 ¼" thick
- horizontal rail is 4 ¼" h
- WE8NPT1-43114 panel base with molding 43 ¼" w
- WE8NPT1-31114 panel with base molding 31 ¼" w
- adjustable glides

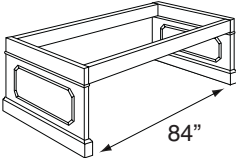
120" Traditional Panel Base  wellington molding shown	31 ¼	89 ⅝	27 ⅞	73	10	WE8NPT1-3190	\$4,274	\$4,340	\$4,607	\$4,607
--	------	------	------	----	----	---------------------	---------	---------	---------	---------

- hardwood solids and veneers
- flat cut, book-matched vertical veneers
- panels are 2 ¼" thick
- horizontal rail is 4 ¼" h
- panel with base molding 31 ¼" w
- adjustable glides

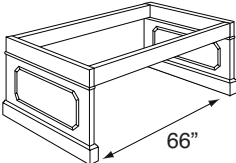
96" Traditional Panel Base  wellington molding shown	31 ¼	71 ⅝	27 ⅞	64	10	WE8NPT1-3172	\$3,489	\$3,555	\$3,825	\$3,825
--	------	------	------	----	----	---------------------	---------	---------	---------	---------

- hardwood solids and veneers
- flat cut, book-matched vertical veneers
- panels are 2 ¼" thick
- horizontal rail is 4 ¼" h
- panel with base molding 31 ¼" w
- adjustable glides

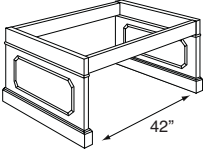
72" Traditional Panel Base  wellington molding shown	25 ¼	47 ⅝	27 ⅞	57	9	WE8NPT1-2548	\$2,793	\$2,862	\$3,128	\$3,128
---	------	------	------	----	---	---------------------	---------	---------	---------	---------

- hardwood solids and veneers
- flat cut, book-matched vertical veneers
- panels are 2 ¼" thick
- horizontal rail is 4 ¼" h
- panel with base molding 25 ¼" w
- adjustable glides

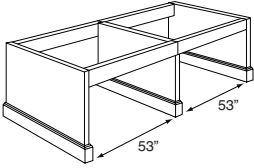
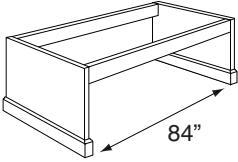
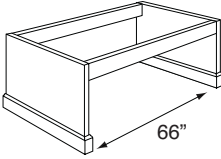
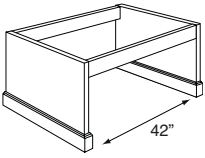
Description	D	W	H	CTN WT	CU FT	① Model	Without Molding (WOM)	Waldon Molding (WDM)
144" Traditional Panel Base  <ul style="list-style-type: none"> walnut solids and veneers flat cut, book-matched vertical veneers molding only on outside end panels panels are 1 1/4" thick horizontal rail is 4 1/4" h GP8NPT1-43114 panel base with molding 43 1/4" w GP8NPT1-31114 panel with base molding 31 1/4" w adjustable glides 	43 1/4	113 3/4	27 7/8			GP8NPT1-43114	\$3,333	\$3,483
	31 1/4	113 3/4	27 7/8			GP8NPT1-31114	\$3,211	\$3,362
120" Traditional Panel Base  <ul style="list-style-type: none"> walnut solids and veneers flat cut, book-matched vertical veneers molding only on outside end panels panels are 1 1/4" thick horizontal rail is 4 1/4" h panel with base molding 31 1/4" w adjustable glides 	31 1/4	89 5/8	27 7/8			GP8NPT1-3190	\$2,947	\$3,097
96" Traditional Panel Base  <ul style="list-style-type: none"> walnut solids and veneers flat cut, book-matched vertical veneers molding only on outside end panels panels are 1 1/4" thick horizontal rail is 4 1/4" h panel with base molding 31 1/4" w adjustable glides 	31 1/4	71 5/8	27 7/8			GP8NPT1-3172	\$2,552	\$2,702
72" Traditional Panel Base  <ul style="list-style-type: none"> walnut solids and veneers flat cut, book-matched vertical veneers molding only on outside end panels panels are 1 1/4" thick horizontal rail is 4 1/4" h panel with base molding 25 1/4" w adjustable glides 	25 1/4	47 5/8	27 7/8			GP8NPT1-2548	\$2,124	\$2,275

To Order, Specify:

- ① Model Number
- ② Wood Species - Cherry (CH1) or Walnut (WA1)
(see page 306)
- ③ Finish Color (see page 306)
- ④ Product Modification (see page 307)

Description	D	W	H	CTN WT	CU FT	① Model	Without Molding (WOM)	Windsor (WNM)	Wellington (WLM)	Westminster (WSM)
Traditional Rectangular Base- End Unit	12	30	27 ³ / ₈	95	8	GP8NRT1-1230	\$1,600	\$1,666	\$1,776	\$1,776
	12	24	27 ³ / ₈	67	6	GP8NRT1-1224	\$1,499	\$1,547	\$1,649	\$1,649

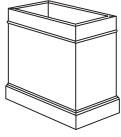

- hardwood solids and veneers
- flat cut, book-matched vertical veneers
- adjustable glides

Traditional Rectangular Base- Mid Unit	12	30	27 ³ / ₈	85	8	GP8NRTL-1230	\$1,667	\$1,736	\$1,843	\$1,843
	12	24	27 ³ / ₈	59	6	GP8NRTL-1224	\$1,561	\$1,609	\$1,711	\$1,711

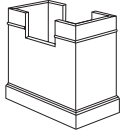

- hardwood solids and veneers
- flat cut, book-matched vertical veneers
- cut-out for wire pass-through
- adjustable glides

Traditional Rectangular Base- End Unit with Access Door	12	30	27 ³ / ₈	86	8	GP8NRTK-1230	\$1,940	\$2,008	\$2,116	\$2,116
	12	24	27 ³ / ₈	60	6	GP8NRTK-1224	\$1,814	\$1,862	\$1,964	\$1,964

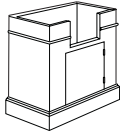

- hardwood solids and veneers
- flat cut, book-matched vertical veneers
- cut-out for wire pass-through
- adjustable glides
- access door opening: 12¹/₈" x 11⁷/₈"

Description	D	W	H	CTN WT	CU FT	① Model	List Price
Visual Board with Doors	5	48	48	135	8	GPOVIS1-0548	\$2,979

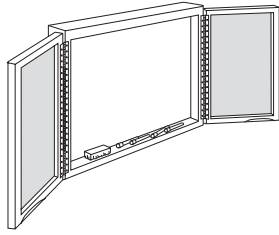

- two tackable cork panels
- porcelain magnetic non-glare writing surface
- mounted flip chart pad
- eraser and four markers
- finger grip doors
- wall mounting brackets

Meeting Room Credenza	24	71 3/8	36	330	44	MRC8072-36	\$6,925
-----------------------	----	--------	----	-----	----	------------	---------

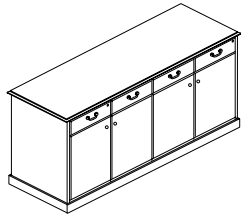

- four drawers
- top shaped all sides
- one adjustable shelf per double door
- locking doors available, specify and add \$210 list

To Order, Specify:

- ① Model Number
- ② Wood Species - Cherry (CH1) or Walnut (WA1)
(see page 306)
- ③ Finish Color (see page 306)
- ④ Top Option (see page 308)
- ⑤ Pull Style and Color ▲
- ⑥ Product Modification (see page 322)



Flat Screen Mount - Universal Bracket (standard with TV, DTV and FSTV model)

Peerless® ST650 universal tilting flat screen mount is supplied with the FSTV Flat Screen Mounting Frame.

- For use with 32"-50" screens
- Maximum weight 175 lbs. (79kg)
- Tilt 15° forward and -5° backward angles
- Mounting pattern allows up to 6" of vertical adjustment

NOTE: To verify TV interface to universal bracket

1. Access website - www.peerlessmounts.com
2. Locate "Mount Finder™" on home page side navigation bar
3. Enter make and/or model of your flat screen
4. Verify model: ST650 is listed as available model

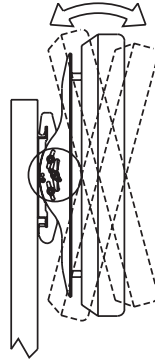

Description	D	W	H	CTN WT	CU FT	① Model	List Price
Power and Data Tilt Out	30	9		7	6	EC4	\$3,654

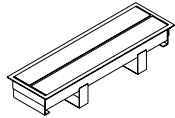

closed

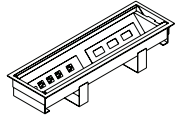

open

- 30" power and data unit
- retractable doors
- standard in silver pearl powder coat
- brush aluminum doors available; specify and add \$1,583 list ▲
- door design allows cords/cables to exit while doors are in closed position
- seven power receptacles
- one dual powered USB
- six cut outs for voice/data plates
- accepts up to six Type 1 Telecom Plates; sold separately, see page 327
- power inserts are UL or ETL listed
- two 108" power cords with molded plugs

15" Power and Data Unit	15	9		4	2	EC5	\$2,335
-------------------------	----	---	--	---	---	-----	---------

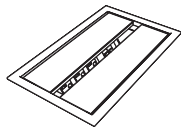

closed

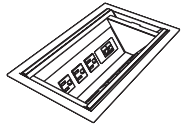

open

- retractable doors
- available in silver pearl powder coat
- brush aluminum doors available; specify and add \$792 list ▲
- door design allows cords/cables to exit while doors are in closed position
- three power receptacles
- one dual powered USB
- three cut outs for voice/data plates
- accepts up to three Type 1 Telecom Plates; sold separately, see page 327
- power inserts are UL or ETL listed
- 108" power cord with molded plug

Dual Sided Power and Data Unit	11 ½	14 ¾		7	2	EC6	\$1,629
--------------------------------	------	------	--	---	---	-----	---------

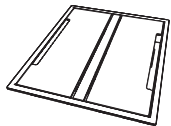

closed

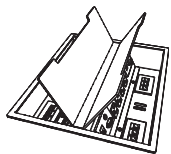

open

- door design allows cords/cables to exit while doors are in closed position
- eight power receptacles, four per side
- accepts up to eight Type 1 Telecom Plates; sold separately, see page 327
- lids lift to open and contain an access slot to allow cords to exit while in use
- available in silver pearl and black texture powder coat
- units are UL listed and CSA certified
- 108" power cord with molded plug

To Order, Specify:

- ① Model number

When ordering Quickship products, place a "Q" in front of model number.
Example: QAK1



Description	D	W	H	CTN WT	CU FT	① Model	List Price
Single Sided Power and Data Unit	5 3/8	9		4	1	EC7	\$619



- two power receptacles
- accepts one Type 1 Telecom Plate; sold separately, see page 327
- additionally accepts up to (4) Type 2 Telecom Jacks
- lid lifts to open and contain an access slot to allow cords to exit while in use
- available in silver pearl or black textured powder coat finish
- units are UL listed and CSA certified
- 108" power cord with molded plug

Single Sided Power and Data Unit	7 1/8	12 1/2		4	2	EC8	\$829
----------------------------------	-------	--------	--	---	---	-----	-------

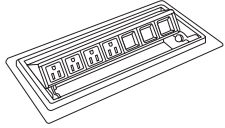

- four power receptacles - 120 volt, 15 amp and three openings for voice/data jacks ▲
- adapter kit provided to accept jacks from most port manufacturers (see page 331)
- accepts up to three Type 3 Telecom Jacks (see page 331)▲
- push to open retractable doors
- allows for doors to close while in use
- clear anodized aluminum
- 72" power cord with molded plug

Single Sided Power and Data Unit	8 3/8	4		3	1	EC9	\$723
----------------------------------	-------	---	--	---	---	-----	-------

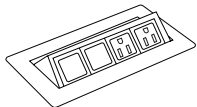

- two power receptacles - 120 volt, 15 amp and two openings for voice/data jacks
- adapter kit provided to accept jacks from most port manufacturers (see page 331)
- accepts up to two Type 3 Telecom Jacks (see page 331)
- push to open pop up door
- clear anodized aluminum
- 72" power cord with molded plug
- UL listed

Mini Power and Data Tilt Up	4 1/4	5 1/2		6	1	EC10	\$352▲
-----------------------------	-------	-------	--	---	---	------	--------



- fluid one touch tilt up access
- one power receptacle - 120 volt; 15 amp and one voice/data port
- adapter kit provided to accept jacks from most port manufacturers (see page 331)
- accepts one Type 3 Telecom Jack (see page 331)
- 72" power cord with molded plug
- drop in field installation required
- cut out provided in top at specified location (see page 330)
- UL listed component
- Black or Silver finish

Mini Power Tilt Up	4 1/4	5 1/2		6	1	EC11	\$367▲
--------------------	-------	-------	--	---	---	------	--------

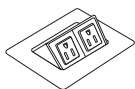

- fluid one touch tilt up access
- two power receptacles - 120 volt; 15 amp
- 72" power cord with molded plug
- drop in field installation required
- cut out provided in top at specified location (see page 330)
- UL listed component
- Black or Silver finish

Mini Power and USB Tilt Up	4 1/4	5 1/2		6	1	EC12	\$458▲
----------------------------	-------	-------	--	---	---	------	--------



- fluid one touch tilt up access
- one power receptacle - 120 volt; 15 amp dual powered USB
- 72" power cord with molded plug
- drop in field installation required
- cut out provided in top at specified location (see page 330)
- UL listed component
- Black or Silver finish

Description	D	W	H	CTN WT	CU FT	① Model	List Price
Dual Power and Data Tilt Up	8	8 3/8		16	1	EC13	\$934

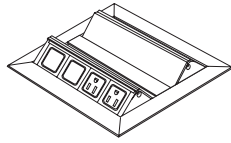

- fluid one touch tilt up access
- back to back tilt sections
- four power receptacles (2 per side) - 120 volt; 15 amp with four openings for voice/data jacks (2 per side) ▲
- adapter kit provided to accept jacks from most port manufacturers ▲
- accepts up to four type 3 telecom jacks (see page 331) ▲
- two 72" power cord with molded plug
- drop in field installation required
- cut out provided in top at specified location
- UL listed component
- available in Silver (S)

Edge Mount Electrical	3	10		16	1	EC15	\$415
-----------------------	---	----	--	----	---	------	-------

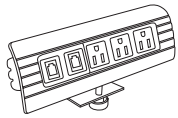

- mounts to the edge of the worksurface
- three power receptacles - 120 volt; 15 amp with two voice/data ports ▲
- adapter kit provided to accept jacks from most port manufacturers ▲
- accepts up to two type 3 telecom jacks (see page 331) ▲
- 6" power cord with molded plug
- UL listed component
- clear anodized aluminum

Wire Management Channel	1/2	36	1	4		36WC	\$54
	1/2	24	1	3		24WC	\$49
	1/2	12	1	2		12WC	\$42

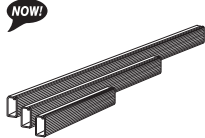

NOW!

- available in 12", 24" and 36" increments
- field installed with adhesive tape provided

Wire Management Trough	2 1/2	36	2 1/2	3		36WCT	\$108
	2 1/2	24	2 1/2	3		24WCT	\$98
	2 1/2	12	2 1/2	2		12WCT	\$83

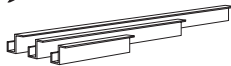

NOW!

- available in 12", 24" and 36" increments
- field installed with screws provided

To Order, Specify:

- ① Model number

Description	D	W	H	CTN WT	CU FT	① Model	List Price
-------------	---	---	---	-----------	----------	---------	------------



- used on square top configuration
- spring loaded - touch release pop up
- two power receptacles - 120 volt; 15 amp and one telecom plate cut out on each side
- accepts up to four Type 1 Telecom Plates; sold separately, see page 327
- 72" power cord with molded plug
- field installation required
- cut out provided in top at specified location (see page 330)
- must be located above 24" or larger round or square base
- black metal top, trim and housing standard
- brushed stainless steel top and trim available, specify and add \$577 list upcharge
- CSA certified component

Power and Data Pop Up	5	5		12	2	EC2	\$1,310
------------------------------	---	---	--	----	---	------------	----------------

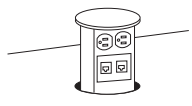

- used on square or round top configuration
- spring loaded - touch release pop up
- two power receptacles - 120 volt; 15 amp and one telecom plate cut out on both sides
- accepts up to two Type 1 Telecom Plates; sold separately, see page 327
- 72" power cord with molded plug
- field installation required
- cut out provided in top at specified location (see below)
- must be located above 18" or larger round or square base
- black metal top, trim and housing standard
- brushed stainless steel top and trim available, specify and add \$462 list upcharge
- CSA certified component

Power Strip	1 ½	1 ¾	8			GP9ACP1-0212	\$65
--------------------	-----	-----	---	--	--	---------------------	-------------

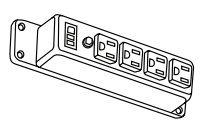

- includes switch
- power surge with 10' cord
- four electrical outlets
- field installed

Wire Management Trays	7 ½	45				GP9WMT1-0845	\$192
	7 ½	35				GP9WMT1-0835	\$162
	7 ½	25				GP9WMT1-0825	\$131

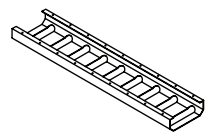

- silver powder-coated finish
- four hanging brackets (CI2C00)

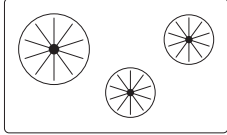
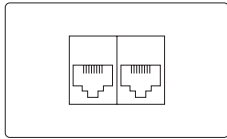
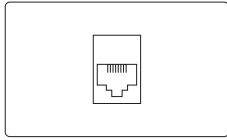
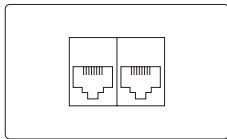
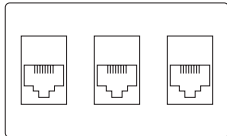
Description	D	W	H	CTN WT	CU FT	① Model	List Price
Data Plate - Blank Cap 		1 3/4	3 1/8			TCP101	\$8
Data Plate - Three Cord Bushings 		1 3/4	3 1/8			TCP102	\$41
Data Plate - Two Jacks  <ul style="list-style-type: none"> · one RJ11 Cat3 Jack · one RJ-45 Cat6 Jack 		1 3/4	3 1/8			TCP103	\$104
Data Plate - One Jack  <ul style="list-style-type: none"> · one RJ-45 Cat6 jack 		1 3/4	3 1/8			TCP104	\$73
Data Plate - Two Jacks  <ul style="list-style-type: none"> · two RJ-45 Cat6 jacks 		1 3/4	3 1/8			TCP105	\$139
Data Plate - Three Jacks  <ul style="list-style-type: none"> · three RJ-45 Cat6 jacks 		1 3/4	3 1/8			TCP106	\$203

To Order, Specify:

① Model number

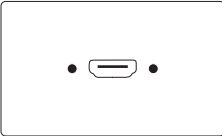
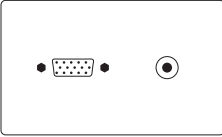
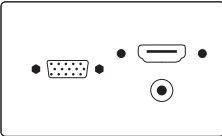
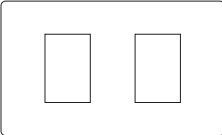
Description	D	W	H	CTN WT	CU FT	① Model	List Price
Data Plate - HDMI  <ul style="list-style-type: none"> · one HDMI female to female with 36" cord 		1 3/4	3 1/8			TCP107	\$162
Data Plate - VGA and Mini-Stereo  <ul style="list-style-type: none"> · one VGA female to female with 72" cord · one Mini-Stereo Inline 		1 3/4	3 1/8			TCP108	\$167
Data Plate - VGA, HDMI and Mini-Stereo  <ul style="list-style-type: none"> · one VGA female to female with 72" cord · one HDMI female to female with 36" cord · one Mini-Stereo Inline 		1 3/4	3 1/8			TCP109	\$317
Data Plate - Two Open Data Ports  <ul style="list-style-type: none"> · used with two Type 3 Telecom Jacks; see next page 		1 3/4	3 1/8			TCP110	\$12

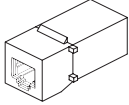
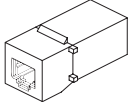
Description	D	W	H	CTN WT	CU FT	❶ Model	List Price
Phone Jack  <ul style="list-style-type: none"> · RJ-11 phone jack 						TCP201	\$77
Data Jack  <ul style="list-style-type: none"> · CAT6-RJ45 data jack 						TCP202	\$77

To Order, Specify:

❶ Model number

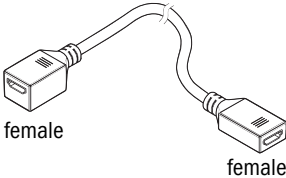
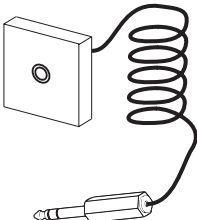
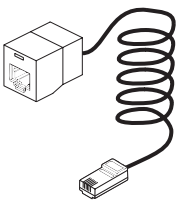
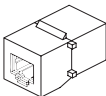
Description	D	W	H	CTN WT	CU FT	① Model	List Price
 <p>female female</p> <ul style="list-style-type: none"> · HDMI coupler · 18" cord · female to female connection 						TCP301	\$83
 <ul style="list-style-type: none"> · 3.5 mm Mini Stereo Jack · 10 foot cord · female to male connection 						TCP302	\$23
 <ul style="list-style-type: none"> · Cat5e RJ-45 Panduit Jack · Pre-terminated · 9 foot cord · 8-Pin 						TCP303	\$75
 <ul style="list-style-type: none"> · AMP Category 3, RJ-11 · 6-Pin · connects to standard phone cord 						TCP304	\$75

Data plates for EC1 and EC2 provided with units:

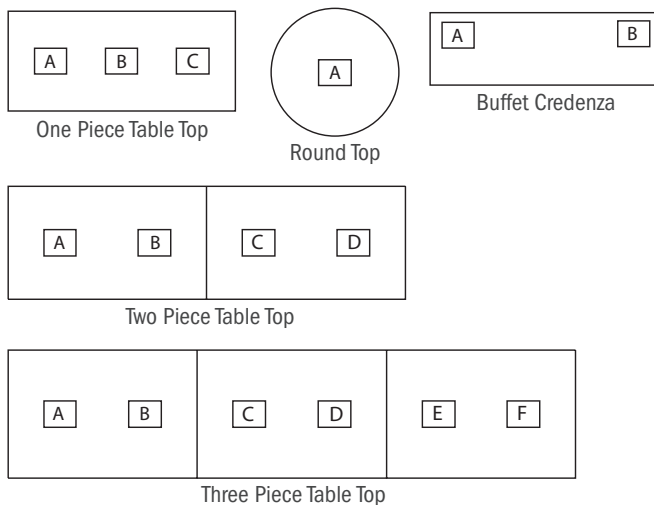

- Verify fit of jack in adapter before ordering large quantities as manufacturer designs may change without notice.
- Installation of Power and Data units on a seam of multi piece tops should be avoided when possible.
- Specify location when ordering conference tops or buffet credenza.
- Standard power and data units are indicated from the side of conference tops and user side of buffet credenza.

Data Adapter Applications

Data adapter kits ship with each power and data unit.

Adapter plates are marked on the back with letter designators to indicate the data jack manufacturer, series and style. Websites are listed below for quick reference to verify data jack series or style.

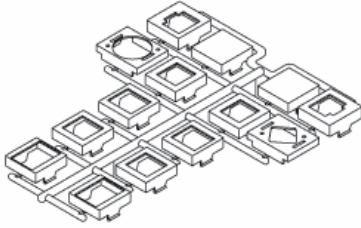

Included with EC8, EC9, EC10, EC13, EC15, TCP110 and CC9CNE1-0708.▲

NOTE: Verify fit of data jack in adapter before ordering large quantities as manufacturer designs may change without notice.

Adapter	Manufacturer	Website
AA	Uniprise/Systimax/Avaya	www.uniprisesolutions.com
BB	Tyco SL and 100 Connect Series Modular Jacks	www.ampconnect.com
BB	Siemon Keystone Style	www.siemon.com
BB	Allen Tel Versa Tap Series	www.allentel.com
BB	Leviton Quick Port® Series	www.leviton.com
BB	Nordx Keystone Style	www.nordx.com
CC	Tyco SL Coupler Series	www.ampconnect.com
CC	Krone 6000 Series	www.adc.com
CC	Hubbell Xcelerator™ Keystone Series	www.hubbell.com
DD	Blank (no coupler/jack)	
EE	Ortronics TracJack Series	www.ortronics.com
FF	Panduit Mini-Com Series	www.panduit.com
GG	Microphone jack/3-pin XLR, solder type only	
HH	Video Monitor jack/DB-15, panel mount solder style	

The TCP110 Type 1 Data plate comes with the adaptor kit to allow installation of data jacks listed above. The TCP110 can be installed in the EC1, EC2, EC4, EC5, EC6, EC7.

