

Tiles

Standard Fabric, Fire-Rated Fabric, Wood, Laminate and Painted Tiles

Statement of Line	▶ See page 7
Planning	17
Pricing	61
Finishes & Materials	215

Details

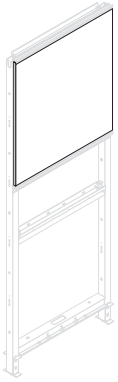

Tiles are available in a variety of widths (6" to 96") and heights (.5-high to 5-high). Reference pricing pages for specific sizes available for each tile type.

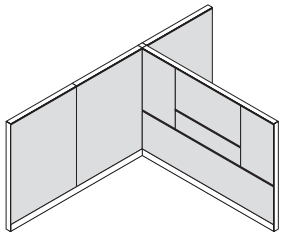

Vertical and horizontal monolithic or segmented aesthetics can be created with the use of tiles.

Standard fabric tiles are constructed of tackable MDF and cover in fabric. Fabric is applied railroad style. Standard fabric tiles are class C fire rated.

Fire-rated fabric tiles are constructed of fiberglass and covered in fabric. They can be field scribed if necessary. Fabric is applied railroad style. Fire-rated fabric tiles are class A rated.

Wood, laminate and painted tiles are constructed of a 7/16" wood composite core and covered with premium-grade wood veneer or laminate, or painted.

Wood, laminate and painted tiles are very durable and are recommended for use under a work surface, in lower positions in corridors or beside marker tiles. They can also be used to provide visual interest when creating a segmented look.

Combination tiles are available in standard fabric, standard fabric/laminate, or standard fabric/wood. Combination tiles require a mid-frame support behind the tile at the location where the upper and lower sections connect.

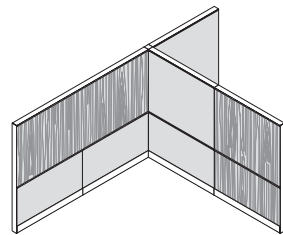

Woodgrain direction runs vertical on wood and woodgrain laminate tiles.

Finishes & Materials

- Panel fabrics
- Wood
- TFL
- Paint (excluding metallic paint)

Connections

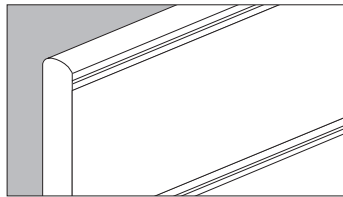

Tiles are held in place on the frame by Narrate Traxx at the top and bottom of the tile.

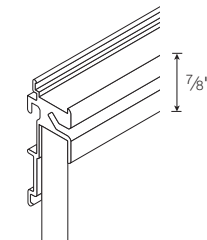

Support Traxx

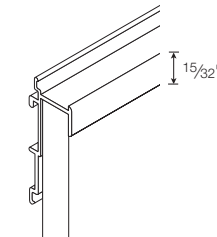

Trim Traxx

Traxx extends beyond the face of the tile by 1/16".

Power & Data

Power and data can be routed vertically in the panel's interior behind standard fabric, fire-rated fabric, wood, laminate, painted, back-painted, and combination tiles.

Planning Factors

Specify tiles for both sides of the frame to complete the panel. Tiles may be omitted on panel runs where visually acceptable, provided no components are on the affected side of the frame.

Acoustical Ratings:

Fire-Rated Fabric Tiles

NRC = 0.70

STC = 13

Electrical:



Class A—Fire-rated fabric tiles.
Note: COM must comply with U.L. Standard 1286

Class B—Laminate tiles

Class C—Standard fabric, wood and painted tiles

Tiles

Framed or Back-Painted Glass

Statement of Line	▶ See page 7
Planning	17
Pricing	61
Finishes & Materials	215

Details

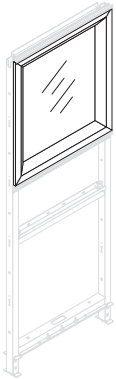

Framed glass tiles have an extruded aluminum frame (painted or covered with premium grade veneer) with 3mm-thick (clear or frosted) tempered glass. Glass tiles are available in clear or frosted. Glass tiles cannot be field scribed.

Framed glass tiles consist of two tile frames (one for each side of the frame) with a single pane of tempered glass between them. Only one glass tile is needed to complete both sides of the frame. They are available in 1-, 1.5-, 2-, and 3-high models.

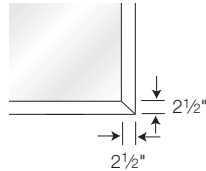

Frames on glass tiles are 2 1/2"W.

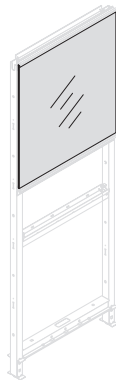

Back-painted glass is available in full painted back or painted with opening in center to allow viewing of panel mounted TV.

Back-painted glass tiles are available in six paint options. Tiles come in widths from 18" to 96" and 1-, 1.5-, 2- and 3-high heights.

Finishes & Materials

- Glass tile frames: paint or wood
- Glass panes: clear or frosted tempered glass
- Back-painted glass: paint

Connections

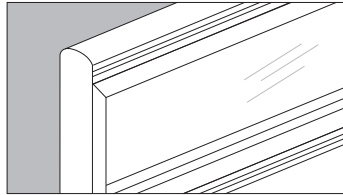

Tiles are held in place on the frame by Traxx at the top and bottom of the tile or by the frame at the bottom when tile is in the bottom segment on the frame.

Traxx extends beyond the face of the tile by 1/16".

Power & Data

Power and data cannot be routed through glass tiles.

Planning Factors

Tiles must be specified for both sides of frames when using back-painted tiles as tile opposite of back-painted glass can be different tile type.

Mid-frame support can be removed or relocated if the standard placement interrupts the placement of a glass or framed tile.

Hanging overheads over glass tiles is not recommended.

Consider accessory location. They may obstruct the view through glass tiles.

Glass cannot be field scribed.

Tiles

Metal Tiles

Statement of Line	▶ See page 7
Planning	17
Pricing	61
Finishes & Materials	215

Details

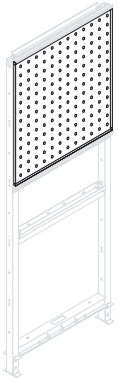

Metal tiles are available plain or with a perforated or embossed (shown) surface.

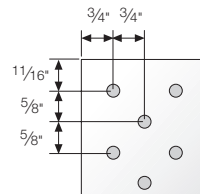

Pattern of perforated or embossed tiles is consistently spaced on centerlines.
Perforation hole size: $\frac{3}{16}$ " (5 mm)
Embossed circle size: $\frac{3}{8}$ " (10 mm)

Finishes & Materials

- 18 gauge steel: paint

Connections

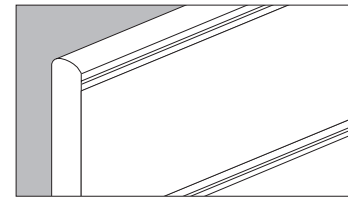

Tiles are held in place on the frame by Traxx at the top and bottom of the tile or by the frame at the bottom when tile is in the lowest segment on the frame.

Narrate Traxx extends beyond the face of the tile by $\frac{1}{16}$ ".

Planning Factors

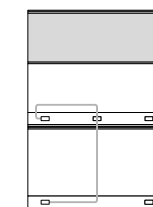

Do not use a perforated metal tile below a technology tile to avoid seeing the jumper passing through the structure.

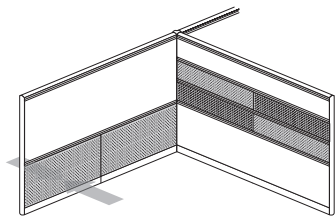

Perforated metal tiles, when used on both sides of a frame, increase ventilation below the worksurface or behind computer equipment. If perforated tiles are used on both sides of a run, it is recommended that they be the same size.

Metal tiles are washable, durable, and magnetic.

Tiles

Markerboard and Slat Tiles

Statement of Line	▶ See page 7
Planning	17
Pricing	61
Finishes & Materials	215

Details

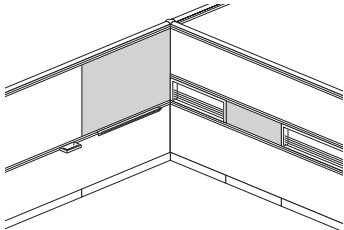

Markerboards are available in metal or laminate models in a variety of tile widths and heights to provide a larger writing surface for meeting spaces and smaller surfaces for private workspaces.

Expo or Expo2 dry erase markers are recommended for use on markerboards. Low-odor dry erase markers are not recommended, as they may leave undesirable results when erased.

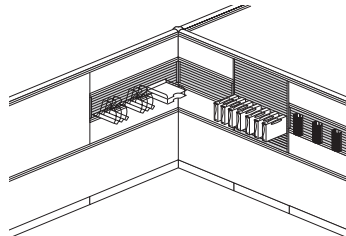

Slat tiles allow work tools to be placed in appropriate areas to accommodate individual user needs. They accommodate all Kimball Office Perks metal work tools.

Note: Narrate work tools hang on support Traxx only. Hanging tools from support Traxx eliminates the need for slat tile unless using Perks work tools.

2-high slat tiles require a mid-frame support behind the tile; **3-high slat tiles** require two mid-frame supports behind the tile.

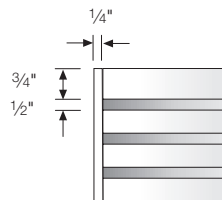

Slats are 3/4"H; space between slats is 1/2"H. Trim channel is 1/4"W.

- .5-high = 4 slats
- 1-high = 8 slats
- 1.5-high = 14 slats
- 2-high = 18 slats
- 3-high = 28 slats

Finishes & Materials

Metal Markerboard Tiles

- 18 gauge steel: 405 Designer White markerboard paint

Laminate Markerboard Tiles

- Core: standard 7/16" wood composite
- Erasable markerboard surface: 409M Icey White or 483M Off White
- Vertical edges: black PVC

Slat Tiles

- Extruded aluminum: paint

Connections

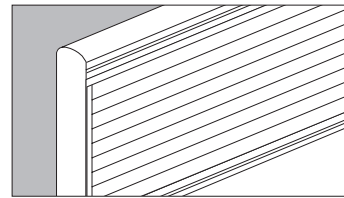

Tiles are held in place on the frame by Traxx at the top and bottom of the tile or by the frame at the bottom when tile is in the lowest segment on the frame.

Traxx extends beyond the face of the tile by 1/16".

Monitor arms can be used on 18", 24", and 30"W 1-high and 2-high slat tiles. 2-high and 3-high tiles require an additional mid-frame support, specified separately. Only one monitor arm per slat tile can be accommodated.

Trim channel on slat tiles prevents tools from spanning across two slat tiles. Tools can hang within 1/4" of edge of the tile. Trim can be removed to allow tools to span across two slat tiles.

Planning Factors

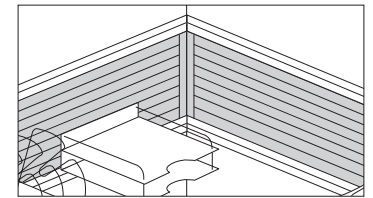

Slat tiles can be placed at right angles to each other in a corner.

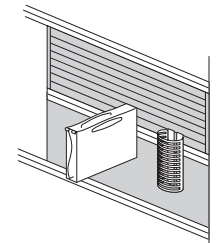

Consider what will be above and below the accessory. It may interfere with other tiles such as glass or markerboard.

Tiles

Fold-Down Tiles

Statement of Line	▶ See page 7
Planning	17
Pricing	61
Finishes & Materials	215

Details

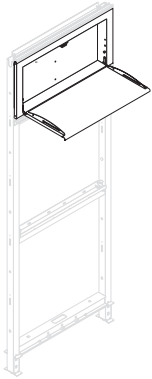

Fold-down tiles maximize space by using the interior of the structure. Available in 1-high in four widths: 18", 24", 30", and 36".

Fold-down tile features a one-piece door that can be opened to provide a surface for impromptu meetings. Fold-down surface heights:

Mounted at	Surface height
2-high	17¼"
3-high	30"
4-high	42½"
5-high	55"
6-high	67¾"
7-high	80¼"

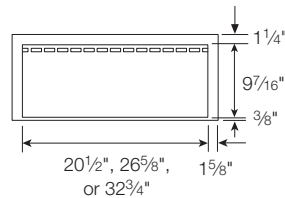

Finishes & Materials

Tile

- 18 gauge steel: paint

Planning Factors

Specify any tile, except glass tiles, perforated, or technology tiles, for the opposite side of the panel behind fold-down tiles.

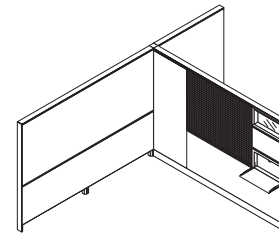

Fold-down tiles can be installed at the 2-high segment and above. On a 3.5-high frame, they can be installed at worksurface height with a .5-high tile above.

Fold-down tiles cannot cross a frame or connector and cannot be field scribed.

Technology Tiles

Details

Technology tile provides power and data at the 2nd, 3rd, 4th or 5th segments for access below the worksurfaces, at worksurface height, at standing height, or at the overhead position. Technology tiles utilize an 8-wire electrical system.

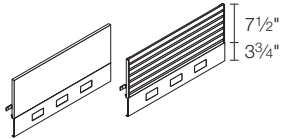

Three upper material options to meet user needs include:

- Tackable fabric
- Marker board
- Slat

Note: Marker board tiles should not be used on unsupported runs due to panel movement when writing on the surface.

Three 2 3/4"W x 1 7/16"W cut-outs are provided in each technology tile to accommodate duplex receptacles and/or data ports. The in-line arrangement of the cut-outs provide a clean aesthetic.

Technology tiles without cutouts are available for a seamless look.

Finishes & Materials

- Tile: formed steel, paint
- Tile header:
 - Tackable fabric
 - Slat: extruded aluminum, paint
 - Erasable markerboard: 409M Icey White or 483M Off White

Connections

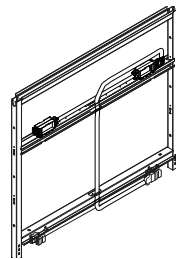

Technology tiles may be powered from the base wireway with a vertical jumper. One base receptacle location will be used for the vertical jumper; no receptacle location in the technology tile is required/lost for the vertical jumper.

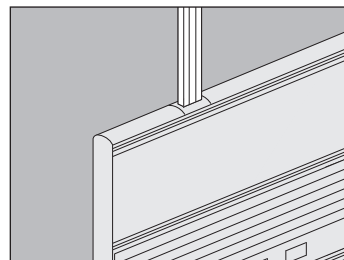

Ceiling power entry can be used to bring power to the technology tile from above.

Power can be jumped from one technology tile to another (frame to frame) or from a frame through a connector to another frame.

Planning Factors



Technology tiles should be placed back to back for optimum component utilization. The same arrangement of duplex and data receptacles should be used in both tiles.

Technology tiles cannot be used back to back with fold-down tiles since both tiles use the interior space.

Specify technology tiles to match the width of the frame.

Technology tiles without cutouts must be specified where pass-thru jumpers will be used.

1-high stacking frames can accept technology tiles where only data is required. Power cannot be installed in this application because the power block mounting brackets must attach to the mid channel.

2-high stacking frames can accept power block mounting brackets if a mid-channel is specified to be installed in the stacking frame.



Hole cover plates, specified separately, are recommended to cover unused power blocks and where cut-out is not being used for data.

Consider the tile below a technology tile in base entry applications. The jumper needs to pass from the base through the interior of the frame to the tile; therefore, storage tiles or any tiles where the jumper may be visible are not recommended.

Power harnesses and receptacles must be specified separately for use with technology tile. These items are not included when a powered panel is specified-power is only in base.

Vertical jumpers are used to jump power from base to tech tile.

Related Products

Technology slat tile can support one or two Perks® single-monitor arms (model 99KSMAM2SMS). Perks work tools are available. ▶See the Perks Price List.

Expo or Expo2 dry erase markers are recommended for use on markerboards. Low-odor dry erase markers are not recommended.

Statement of Line	▶See page 7
Planning	17
Pricing	61
Finishes & Materials	215

Acoustical Ratings:

NRC = 0.70
STC = 13

Electrical:



Class A—Tiles with tackable acoustical header.
Note: COM must comply with U.L. Standard 1286

Class B—Tiles with markerboard header.

End Panels

Details

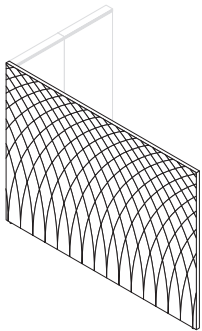

End panels are available in seven material combinations:

- HPL
- TFL
- Wood
- Resin insert with aluminum frame
- Plank
- Plywood (four patterns)
- 3D laminate

Three heights:

- 2-high (29³/₄"
- 3-high (42¹/₃₂"
- 3.5-high (49³/₃₂"

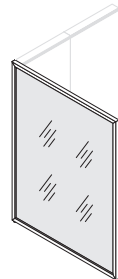

Single sided

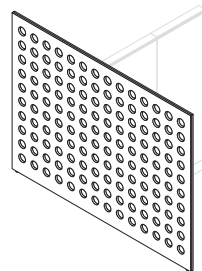

Dual sided

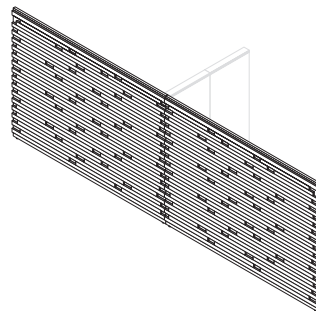

Dual-sided Sets

Three applications:

- Single sided
- Dual sided
- Dual-sided sets

End panels take the place of the connector, frames with Traxx and tiles, and end trim.

Connections

Brackets with screws are standard with all end panels, except resin insert models, to allow the front corner of a worksurface to be attached to the end panel.

When using resin insert with an aluminum frame, separate support is required to support the front corner of a worksurface next to the end panel (e.g., pedestal or support leg).

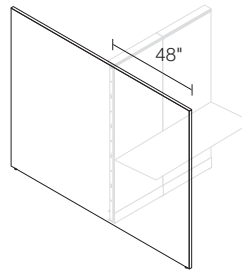

End panels that extend more than 48" out from the spine run should be attached to a worksurface for additional stability.

Planning Factors

End panels range in widths from 27" to 117" in the same materials options. For sizes over 63"W, it is recommended that a surface is attached and a storage unit is specified to sit against the end panel to reduced movement in the panel.

Small voids, an inherent characteristic of plywood, may be visible in edges/patterns on plywood end panels.

Statement of Line	▶ See page 7
Planning	17
Pricing	61
Finishes & Materials	215

Modifications:

Modifications to a standard end panel may include, but are not limited to:

- Unique sizes
- Color change
- Different plywood design
- Custom 6mm material in an aluminum frame

▶ Contact *By Design* with your request at www.kimbaloffice.com/resources/productmods/product-mod-request/

If you are having an artist produce a custom end panel, we recommend that you order frame attachment brackets which will be needed to attach the end panel to the rest of the Narrate station.

For additional details on ordering custom end panels for Narrate:

▶ Contact *By Design* at 1.800.482.1616 x6001 or email Kobydesign@kimball.com

Power & Data Overview

Narrate offers 8-wire and 10-wire power systems for the base wireway and 8-wire power for mid-wireway.

Options include:

- 8-wire shared neutral: 4 hot, 2 neutral, 2 ground
- 10-wire shared neutral: 6 hot, 2 neutral, 2 ground
- 10-wire independent neutral: 4 hot (2 and 2), 4 neutral, 2 ground

Note: Independent and shared neutral components cannot be mixed.

All electrical components are non-directional.

The building's power capability should be determined before power is configured and components are specified.

Narrate is approved to accept Chicago electrical.

Base wireway power harnesses and jumpers distribute power through the base.

Base wireway power entry allows power to enter at the floor, wall, or column. Power can then be distributed to the base and/or jumped up to a technology or power/data tile.

Technology tiles provide access to power and data at 2nd, 3rd, 4th, and 5th segments. Technology tiles utilize an 8-wire system.

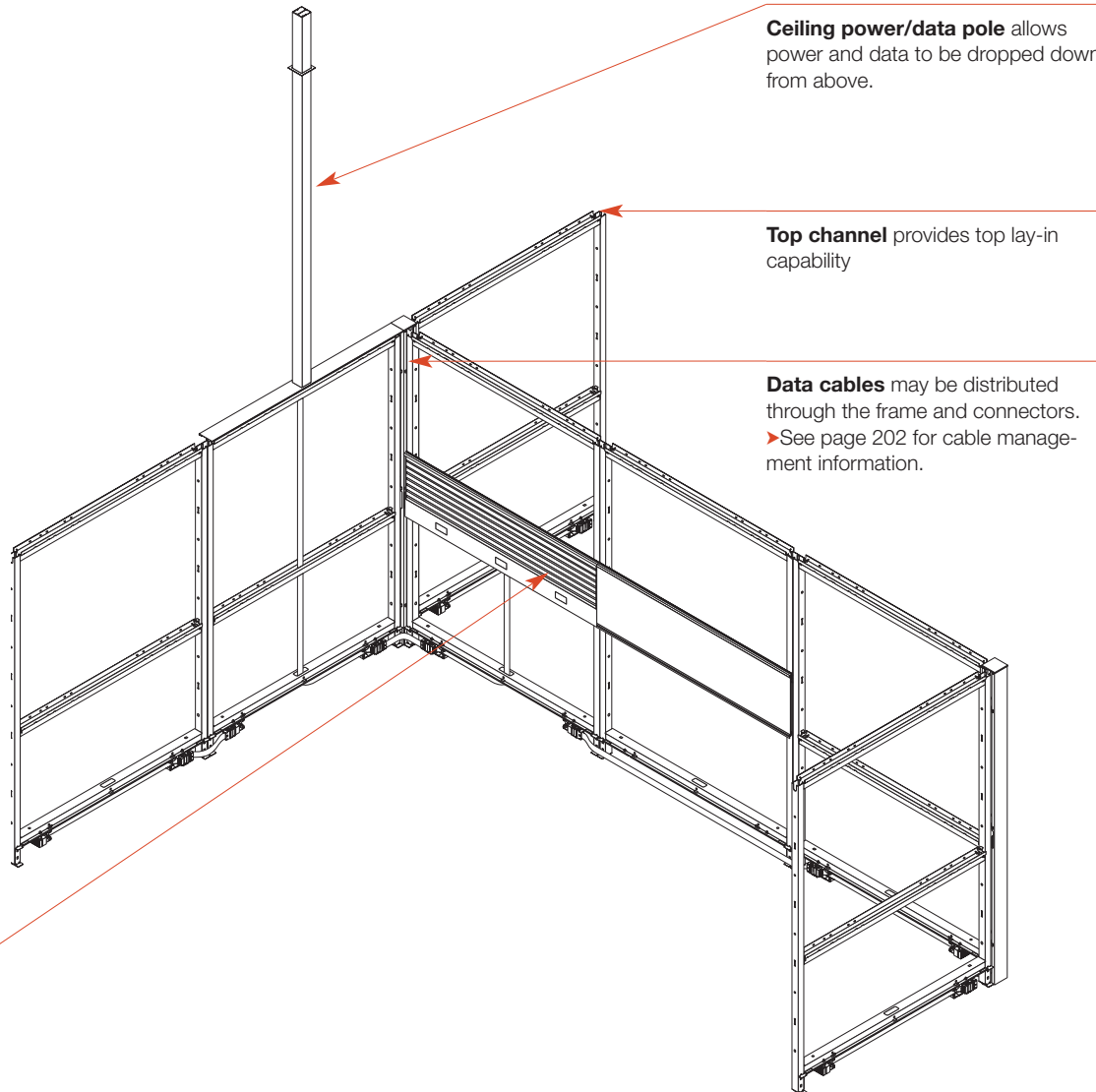

Ceiling power/data pole allows power and data to be dropped down from above.

Top channel provides top lay-in capability

Data cables may be distributed through the frame and connectors.
▶ See page 202 for cable management information.

Statement of Line	▶ See page 7
Planning	17
Pricing	61
Finishes & Materials	215

Wireway Cover Punch Dimensions:

2.80"W x 1.38"H.

Applies to both power and data punches.



No power or data access

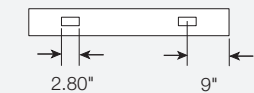

Power access only

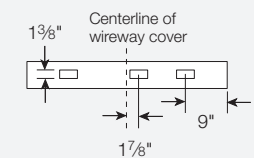

Power and data access

Note: All punched (power and power & data) covers include two wireway cover doors.

▶ See individual frame pricing pages for applicable wireway cover power and/or data punch options.

Base Wireway Components

Harnesses and Receptacles

Statement of Line	▶ See page 7
Planning	17
Pricing	61
Finishes & Materials	215

Details

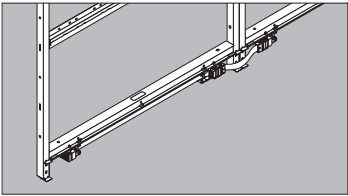

Base wireway harnesses distribute power through the base of the frame.

Dual-sided wireway harness allows for two duplex receptacles per side, for a total of four. Single-sided harness allows for two duplex receptacles on one side.



Duplex receptacles are rated at either 15 or 20 amps and may be installed back-to-back in the base wireway. 20-amp models, required for some large equipment applications, protrude 1/8" more than 15-amp models. Duplex receptacles are available in black, white, or orange for use as a visual aid.

Note: Orange color duplex receptacles for the base wireway do not match the dark orange color for technology tile receptacles.



USB receptacles are available for use when utilizing the shared neutral power and may be installed back to back. USB receptacles are available in black or white.

Up to four receptacles (two per side) can be installed in each base wireway.

Finishes & Materials

Harness

- Ends: injection-molded plastic
- Conduit: 3/4" oval

Connections

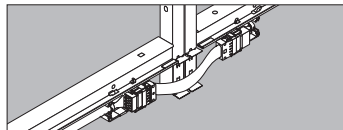

Jumper cables are used to pass power from panel to panel or through non-powered panels.
▶ See page 50.

Building-to-panel power connections can be accomplished whether the power source is in the wall, floor, or ceiling.

Power entry will consume one duplex receptacle location.

Power & data poles bring voice/data cables and electrical wiring from the ceiling to the panel run.
▶ See page 48.

Planning Factors

IMPORTANT: Planning actual power supplies and branch circuits must be performed by qualified electricians or electrical engineers familiar with the National Electrical Code and the appropriate local codes. The information provided herein is intended to assist specifiers.

One receptacle location will be consumed if the harness will have a power entry (floor/wall or ceiling) or jumper for technology tile attached.

Specify a base wireway cover without power or data access if access to power is not needed. Receptacles and a punched wireway cover can be added later as needed.

Independent and shared neutral components cannot be mixed if using 10-wire electrical. 8-wire electrical is always shared neutral.

New York City electrical applications require a special power entry.
▶ See page 51.

Hardwire electrical components for use in the base wireway are available for areas where local codes do not accept modular electrical plug-in components.
▶ See page 52.

Base Wireway Components

Base Wireway Jumpers and Pass-Thru Jumpers

Statement of Line	▶ See page 7
Planning	17
Pricing	61
Finishes & Materials	215

Details

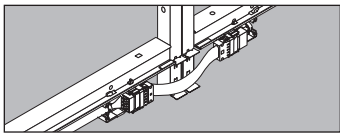

Jumpers continue power between two adjacent base wireway harnesses.

Base wireway jumpers are available in three different models and are specified according to the application. ▶ See chart at right.

Pass-thru jumpers are available in 7 different lengths to pass power through a frame base where duplex receptacles are not required. Size required is determined by application. ▶ See chart on page 194.

Finishes & Materials

- Ends: injection-molded plastic
- Mesh sleeving
- Metal oval conduit

Planning Factors

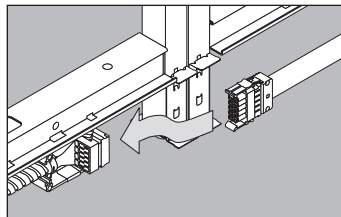

Base wireway jumpers and pass-thru jumpers connect to a base wireway harness on each end. They cannot connect to another jumper.

Independent and shared neutral components cannot be mixed.

Pass-Thru Jumper Selection:

Frame Width to be Passed Thru	Straightline Connections		90° and 120° Connections
	Thru Panel	Thru Connector & Panel	Thru Connector & Panel
18"	33P18EPT*	33P24EPT*	33P24EPT*
24"	33P24EPT*	33P30EPT*	33P30EPT*
30"	33P30EPT*	33P36EPT*	33P36EPT*
36"	33P36EPT*	33P42EPT*	33P42EPT*
42"	33P42EPT*	33P48EPT*	33P48EPT*
48"	33P48EPT*	33P53EPT*	33P53EPT*

* = 8 for 8-wire option or 10 for 10-wire option

Base Wireway Jumpers Connection Guidelines:

Straight-Line Connections:



33PEJB1
Panel to panel



33PEJB5
Through a connector

90° Connections:

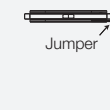

33PEJB2
Through a connector

120° Connections:

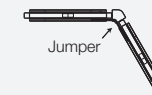

36PEJB5
Through a connector

Base Wireway Components

Power Entries

Statement of Line	▶ See page 7
Planning	17
Pricing	61
Finishes & Materials	215

Details

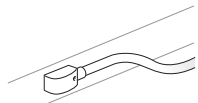

Base power entries deliver power from building to frame.

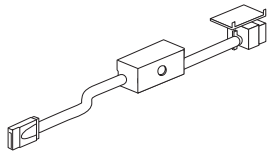

New York City base power entries are available to meet codes that require a hardwired infeed connection to modular electrical systems inside the frame. New York City approval number E44747.

Capacity:

- 8S 8-wire shared neutral in-feed provides four 20-amp circuits
- 10S 10-wire shared neutral in-feed provides six 20-amp circuits
- 10D 10-wire independent neutral in-feed provides four 20-amp circuits

Finishes & Materials

- Black liquid-tight conduit; 4' or 6' length

Connections

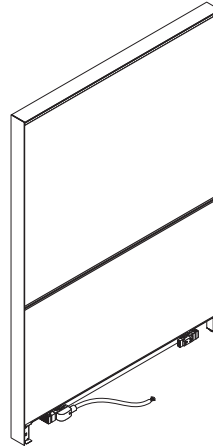

Base power entry can be adjusted in the field for left- or right-hand applications.

New York City model passes power in one direction and accepts base wireway jumper cable on opposite end.

Planning Factors

It is most cost effective to place your infeeds at the ends of spine runs where the highest usage is expected. You can then feed returns only as needed.

Multiple power entries cannot be interconnected.

Independent and shared neutral components cannot be mixed.

System connection to building power must be made by a licensed electrician.

Base power entry extends 1³/₄" from face of frame; allow proper clearance.

One receptacle location will be consumed in the base wireway harness by floor/wall power entry.

If the junction box is on the wall directly behind the system connection, approximately 12" will be required for the conduit. To avoid this space requirement, offset the junction box from the system connection.

New York City model replaces the base wireway harness and eliminates two receptacles. Use in 30"W or greater structure due to box size. The electrical contractor must furnish box fittings, conduit, and wiring from the system junction box to the building power source connection for New York City models.

Base Wireway Components

Hardwire Boxes & Cover Plates

Statement of Line	▶ See page 7
Planning	17
Pricing	61
Finishes & Materials	215

Details

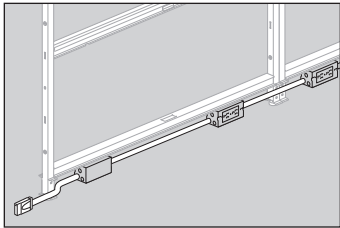

Hardwire components allow field hardwiring of power within the base frame where required by local codes.

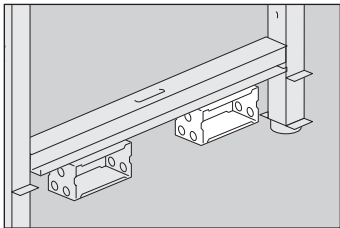

Hardwire box accommodates junctions and receptacles.

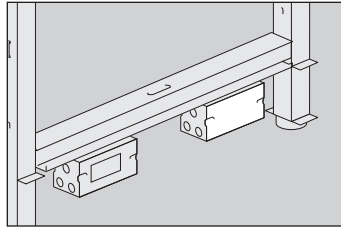

Hardwire cover plate is solid to cover and protect the contents of the hardwire box.

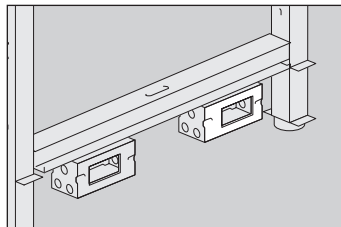

Hardwire cover plate for power provides an access hole, sized to fit Pass & Seymour 26242 series receptacles (or compatible size and type).

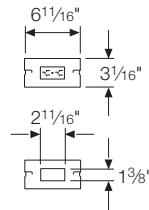

Cover plates are required for both sides of the hardwire box.

Planning Factors

For hardwire applications, specify non-powered panel frame with appropriate wireway cover punch option and hardwire electrical components separately.

Specify power or power and data base wireway covers.

Power/data tiles are compatible with hardwire applications.

Ceiling Power Entries and Power/Data Poles

Details

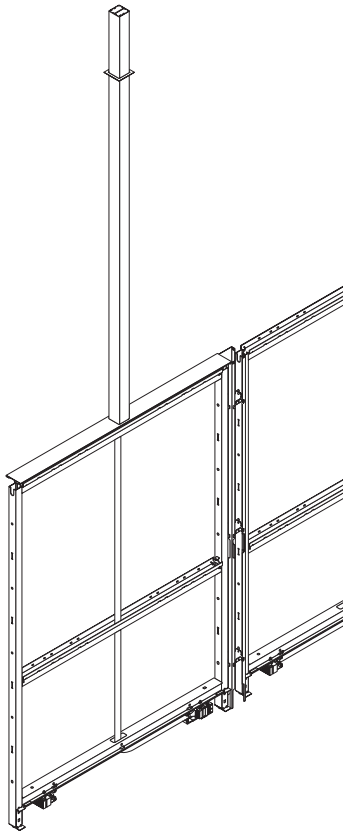

Ceiling power entries deliver building power to the base wireway in applications where power must be dropped down from above to clusters in open areas away from walls or where power is not accessible in the floor. Ceiling power entry is 12' in length.

Ceiling power entry capacity:

- 8S 8-wire shared neutral in-feed provides four 20-amp circuits
- 10S 10-wire shared neutral in-feed provides six 20-amp circuits
- 10D 10-wire independent neutral in-feed provides four 20-amp circuits

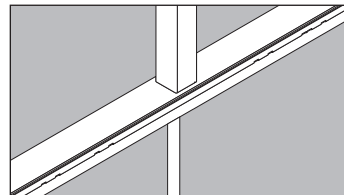

Power/data pole provides a chase for power or data drops from the ceiling. Pole is specified separately from power entry.

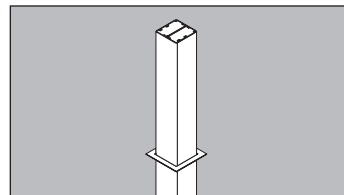

Pole is divided into two sections. A top cap and power pole trim plate are provided to blend into frame top cap. Pole is 5½"W x 82"H.

Power/data pole capacity:

- 32 ¼"-diameter cables at 40% fill (non-powered)
- 28 ¼"-diameter cables at 40% fill (powered)

Finishes & Materials

Ceiling Power Entry

- ¾" oval metal conduit

Power/Data Poles

- Pole: extruded aluminum, paint
- Top cap: painted steel or wood veneer
- Trim plate: paint

Planning Factors

Plan for ceiling power entries

where no glass, storage, or pass-thru tiles are used, since the conduit must have a direct path to the base wireway harness.

Multiple power entries cannot be interconnected.

Independent and shared neutral components cannot be mixed.

System connection to building power

must be made by a licensed electrician. Ceiling power entries do not include junction box and related connectors.

6" of ceiling power entry conduit is required above ceiling for electrical connection.

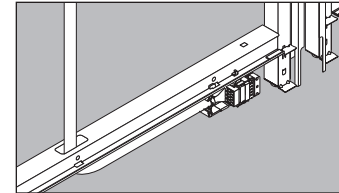

Power entry must plug into right hand block of base wireway harness.

Use ceiling power entry and poles on frame that is a minimum of 24"W

for terminal block to pass through frame opening.

Access to ceiling source is regulated by National Electric Code to 12' maximum conduit for our standard infeed construction. Ceiling power entry in lengths up to 24' are available with custom quote for alternate construction.

New York City approval number is E44747.

Statement of Line	▶ See page 7
Planning	17
Pricing	61
Finishes & Materials	215

Maximum Ceiling Height for Power/Data Pole:

With Ceiling Power Entry

2-high Frame

24"-48"W	100 ¹⁵ / ₁₆ "
----------	-------------------------------------

3-high Frame

24"-48"W	113 ¹ / ₂ "
----------	-----------------------------------

3.5-high Frame

24"-48"W	120 ¹ / ₂ "
----------	-----------------------------------

4-high Frame

24"-48"W	126 ¹ / ₈ "
----------	-----------------------------------

5-, 6-, or 7-high Frame

24"W	140 ³ / ₄ "
30"W	137 ³ / ₄ "
36"W	134 ³ / ₄ "
42"W	131 ³ / ₄ "
48"W	128 ³ / ₄ "

Without Ceiling Power Entry

2-high	100 ¹⁵ / ₁₆ "
3-high	113 ¹ / ₂ "
3.5-high	120 ¹ / ₂ "
4-high	126 ¹ / ₈ "
5-high	138 ³ / ₄ "
6-high	151 ³ / ₈ "
7-high	164"

Base Wireway Electrical System

Shared Neutral 8-Wire (8S) Circuit Configurations & Wiring Diagrams

Statement of Line	▶ See page 7
Planning	17
Pricing	61
Finishes & Materials	215

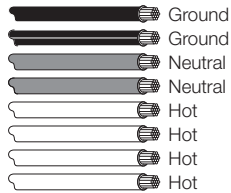

The **8-wire configuration** supports a 3 & 1 or 2 & 2 configuration. The 8-wire system consists of four 12-gauge hot wires, two 10-gauge neutral wires and two 12-gauge ground wires.

▶ See electrical service info at left.
▶ See page 153 for wiring diagrams.

Narrate's 8-wire electrical system

is rated for 20-amp service. To support the usage, 15-amp convenience receptacles can be placed anywhere along the leg of the electrical connection. In the event that an appliance, such as a larger printer/ copier/plotter needs to have a 20-amp receptacle, it is recommended to use a dedicated circuit with a 20-amp receptacle.

Using 15-amp convenience receptacles will aid in ensuring that no one leg of the system can pull too much current, which could potentially cause the system to trip out and lose power across the entire system.

3 and 1 (8-wire):

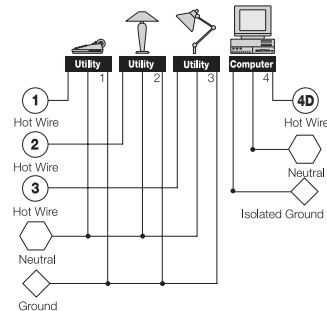

Circuits 1, 2, and 3 share a neutral and common ground, providing circuits for general electrical needs. Customarily, one or more of the circuits is reserved for lighting or other everyday uses, which allows control by central or master switching.

Circuit 4 consists of three separate conductors (hot, neutral, and ground) and meets the BIFMA/ANSI definition for a dedicated circuit.

Circuit	15-amp Model	20-amp Model
1	33PER18S	33PER18S20
2	33PER28S	33PER28S20
3	33PER38S	33PER38S20
4	33PER4D8S	33PER4D8S20

2 and 2 (8-wire):

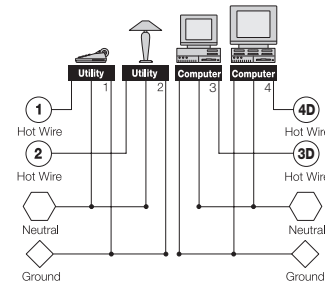

Circuits 1 and 2 provide a pair of designated circuits for general electrical needs.

Circuits 3 and 4 provide a pair of designated circuits for computer applications.

Circuit	15-amp Model	20-amp Model
1	33PER18S	33PER18S20
2	33PER28S	33PER28S20
3	33PER3D8S	33PER3D8S20
4	33PER4D8S	33PER4D8S20

Narrate 3 and 1 Configuration (8-wire):

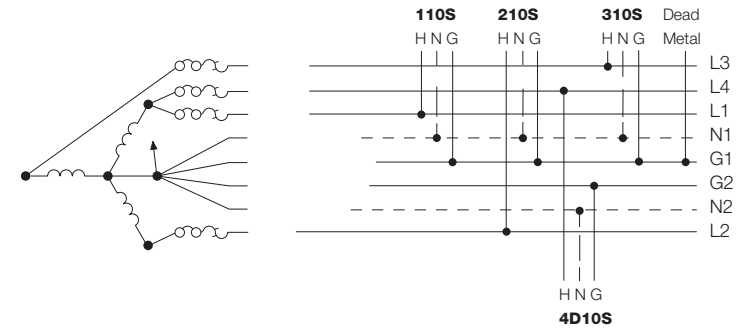

Narrate 2 and 2 Configuration (8-wire):

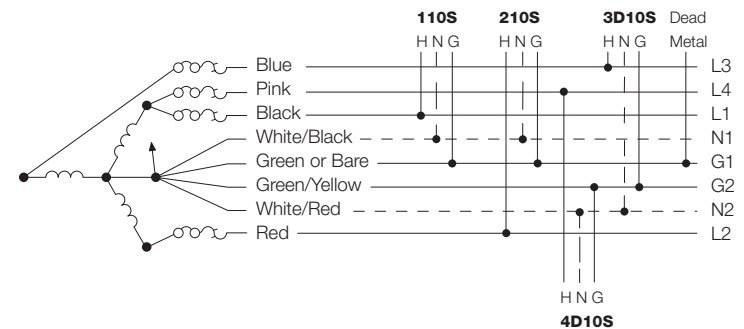

Base Wireway Electrical System

Shared Neutral 10-Wire (10S) Circuit Configurations & Wiring Diagrams

Statement of Line	▶ See page 7
Planning	17
Pricing	61
Finishes & Materials	215

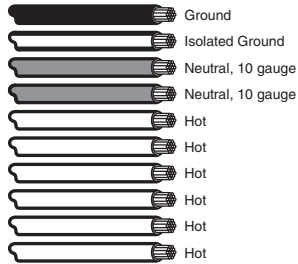

The 10-wire configuration supports work environments having heavy intensity, advanced computerized equipment requirements. A 10-wire system consists of six 12-gauge hot wires, two 10-gauge neutral wires, and two 12-gauge ground wires.

▶ See page 57 for wiring diagrams.

Note: Only 8-wire components are available for mid-wireway application, but can connect to 8- or 10-wire shared base power using base-to-tile jumpers.

▶ See page 54

Xsite's 10-wire electrical system is rated for 20-amp service. To support the usage, 15-amp convenience receptacles can be placed anywhere along the leg of the electrical connection. In the event that an appliance, such as a larger printer/ copier/plotter needs to have a 20-amp receptacle, it is recommended to use a dedicated circuit with a 20-amp receptacle. Using 15-amp convenience receptacles will aid in ensuring that no one leg of the system can pull too much current, which could potentially cause the system to trip out and lose power across the entire system.

IMPORTANT: Planning actual power supplies and branch circuits must be performed by qualified electricians or electrical engineers familiar with the National Electrical Code and the appropriate local codes. The information provided here is intended to assist specifiers. Access to ceiling power source is regulated by National Code to a maximum of 12 ft. conduit.

3 and 3 (10-wire):

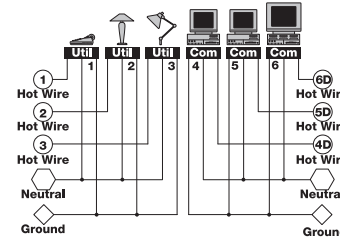

Circuits 1, 2, and 3 share a common 10 gauge neutral and 12 gauge ground wire, providing three designated circuits for lighting and other general/utility equipment.

Circuits 4, 5, and 6 share a common increased size neutral and ground wire, providing three designated circuits for computer applications.

Circuit	15-amp Model	20-amp Model
1	33PER110S	33PER110S20
2	33PER210S	33PER210S20
3	33PER310S	33PER310S20
4	33PER4D10S	33PER4D10S20
5	33PER5D10S	33PER5D10S20
6	33PER6D10S	33PER6D10S20

Narrate 3 and 3 Configuration 10-Wire:

120/208V WYE 3 Phase 8-10 Shared Neutral
Receptacles: 110S, 210S, 310S, 4D10S, 5D10S, 6D10S

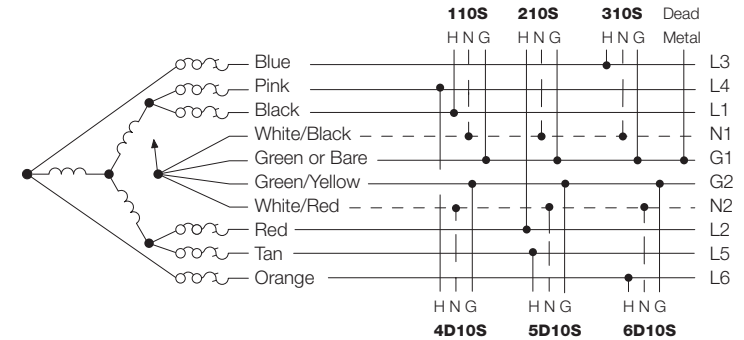

Base Wireway Electrical System

Independent Neutral 10-Wire (10D) Circuit Configurations

Statement of Line	▶ See page 7
Planning	17
Pricing	61
Finishes & Materials	215

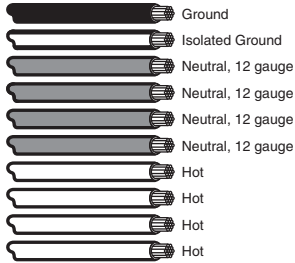

The 10-wire configuration supports work environments having heavy intensity, advanced computerized equipment requirements. An independent neutral 10-wire system consists of four 12-gauge hot wires, four 12-gauge neutral wires, and two 12-gauge ground wires.

▶ See page 57 for wiring diagrams.

Base wireway independent neutral (10D) system cannot be used at belt-line.

Narrate's 10-wire electrical system is rated for 20-amp service. To support the usage, 15-amp convenience receptacles can be placed anywhere along the leg of the electrical connection. In the event that an appliance, such as a larger printer/copier/plotter needs to have a 20-amp receptacle, it is recommended to use a dedicated circuit with a 20-amp receptacle. Using 15-amp convenience receptacles will aid in ensuring that no one leg of the system can pull too much current, which could potentially cause the system to trip out and lose power across the entire system.

IMPORTANT Planning actual power supplies and branch circuits must be performed by qualified electricians or electrical engineers familiar with the National Electrical Code and the appropriate local codes. The information provided here is intended to assist specifiers. Access to ceiling power source is regulated by National Code to a maximum of 12 ft. conduit.

2 and 2 (10-wire):

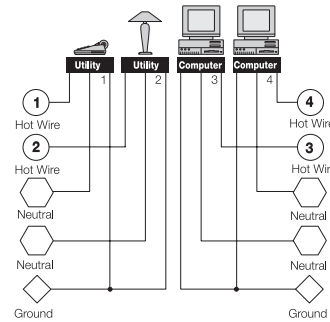

Circuits 1 and 2 each have a neutral wire and share a common ground wire, providing a pair of designated circuits for lighting and other general/utility equipment.

Circuits 3 and 4 each have a neutral wire and share a ground wire, providing a pair of designated circuits for computer applications.

Circuit	15-amp	20-amp
	Model	Model
1	33PER110D	33PER110D20
2	33PER210D	33PER210D20
3	33PER310D	n/a
4	33PER410D	33PER410D20

Base Wireway Electrical System

Independent Neutral 10-Wire (10D) Wiring Diagrams

Statement of Line	▶ See page 7
Planning	17
Pricing	61
Finishes & Materials	215

Provide these wiring diagrams to the electrical contractor.

Narrate 2 and 2 Configuration 10-Wire:

120/208V WYE 3 Phase 8-10 Independent Neutral
Receptacles: 110D, 210D, 310D, 410D

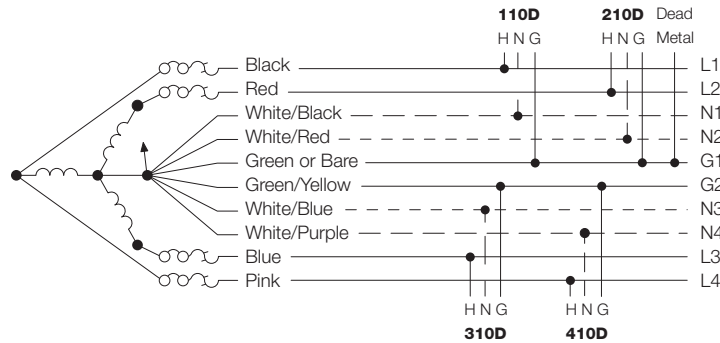

Narrate 2 and 2 Configuration 10-Wire:

120/240V 1 Phase 8-10 Independent Neutral
Receptacles: 110D, 210D, 310D, 410D

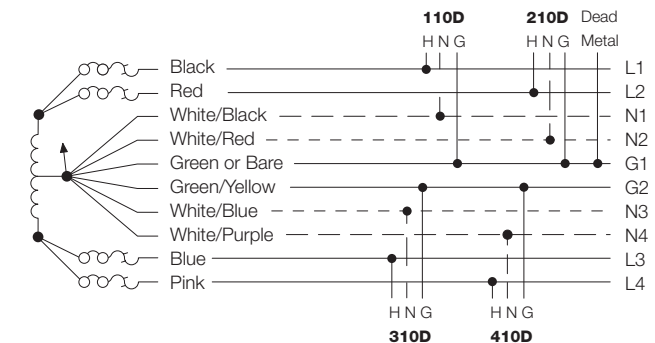

Narrate 2 and 1 Configuration 10-Wire:

120/208V WYE 3 Phase 8-10 Independent Neutral
Receptacles: 110D, 210D, 410D

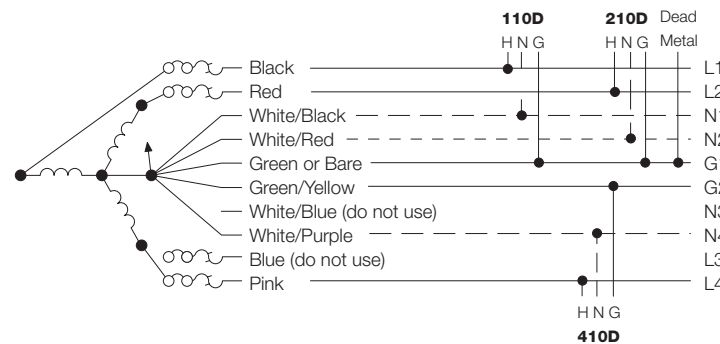

Narrate 1 and 2 Configuration 10-Wire:

120/240V 1 Phase 8-10 Independent Neutral
Receptacles: 110D, 310D, 410D

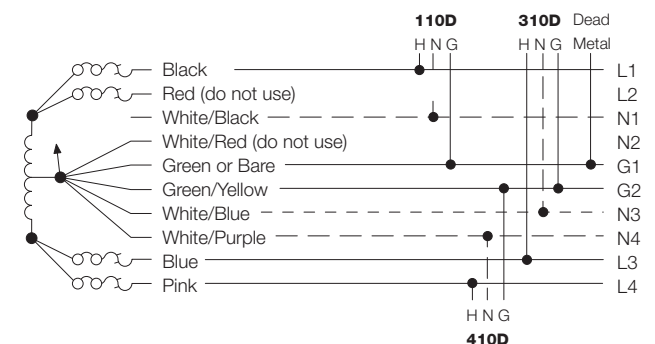

Technology Tile Power/Data Components

Details

Technology tile components are required to provide power and data access to the tile.

Mid-wireway harnesses are available in 8-wire shared neutral only and in dual sided or single sided models. Dual-sided harness provides two receptacle locations per side; single-sided harness allows two receptacles on one side.

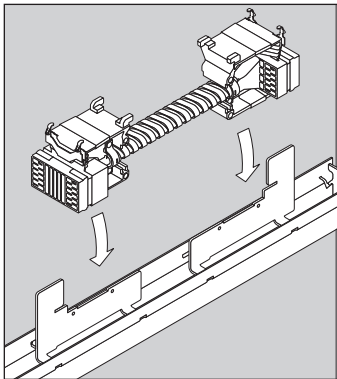

Mounting brackets are included with mid wireway harnesses and attach to the frame crossrails.

The same **8-wire jumpers** that are used in the base for 8S power are utilized with technology tiles at beltline to pass power panel to panel or thru connectors. To bring power from the base to the tech tiles a vertical base-to-tile jumper is specified separately.



Hardwire box (Tech tile) allows hardwiring of electrical at beltline.



Duplex receptacles used in technology tiles are the same as used in the base. The receptacles are available in either 15 or 20 amps.



Hole cover plates, specified separately, are recommended to cover unused power blocks or where cutout is not being used for data.

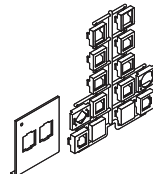

Data plates have two openings and come with a voice/data adapter kit to accommodate couplers/jacks from multiple suppliers. Two of each style of adapter are standard in the kit.
➤ See adapter/manufacture chart.

Connections

Power must be “started” in a 30"W or wider tile. Power cannot be “started” from 24"W tiles due to space constraints.

If open base frames are used, a ceiling power entry can be used to bring power to the technology tile

Receptacle and Data Configuration Options:

24"W

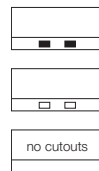

30"W

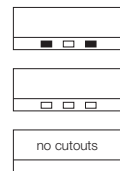

36"W

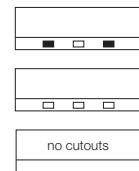

42"W

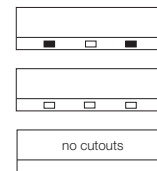

48"W

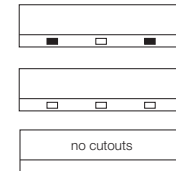

Legend:
■ = Duplex
□ = Data

Statement of Line	➤ See page 7
Planning	17
Pricing	61
Finishes & Materials	215

Data Plate Adapter Reference:

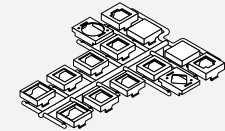

<i>Manufacturer</i>	<i>Adapter*</i>
Systemax/CommScope	AA
Uniprise/CommScope	AA
L-Com Keystone Modular	BB
Tyco SL and 100 Connect Series Modular	BB
Siemon Keystone Style	BB
Allen Tel Versa Tap Series	BB
Leviton Quick Port® Series	BB
Nordx Keystone Style	BB
Tyco SL Coupler Series	CC
Krone 6000 Series/ADC	CC
Hubbell Xcelerator™ Keystone Series	CC
Blank (no coupler/jack)	DD
Ortronics TracJack Series	EE
Panduit Mini-Com Series	FF
Microphone Jack/3-pin XLR, solder type only	GG
Video Monitor Jack/DB-15, panel-mount solder style	HH

*Adapter identifier is located on the backside of the plate.

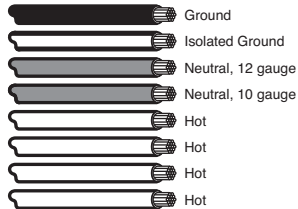

8-wire configuration supports work environments having heavy-intensity advanced computerized equipment requirements. An 8-wire system includes four 12-gauge hot wires, one 12-gauge dedicated neutral wire, one 10-gauge shared neutral wire, and two 12-gauge ground wires.

▶ See electrical service info at left.

▶ See wiring configurations at right and wiring diagrams on the next page.

Base wireway shared neutral (10S) system or ceiling power in-feed should be used technology tiles.

▶ See page 152 for base wireway circuit configurations.

Base wireway independent neutral (10D) system cannot be used with technology tiles.

Xsite's technology tile electrical system is rated for 20-amp service. To support the usage, 15-amp convenience receptacles can be placed anywhere along the leg of the electrical connection. In the event that an appliance, such as a larger printer/copier/plotter needs to have a 20-amp receptacle, it is recommended to use a dedicated circuit with a 20-amp receptacle. Using 15-amp convenience receptacles will aid in ensuring that no one leg of the system can pull too much current, which could potentially cause the system to trip out and lose power across the entire system.

IMPORTANT Planning actual power supplies and branch circuits must be performed by qualified electricians or electrical engineers familiar with the National Electrical Code and the appropriate local codes. The information provided here is intended to assist specifiers.

3 and 1 (8-wire):

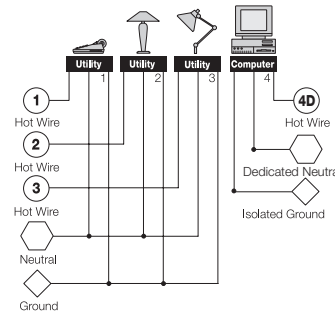

Circuits 1, 2, and 3 share a neutral and common ground, providing circuits for general electrical needs. Customarily, one or more of the circuits are reserved for lighting or other everyday uses, which allows control by central or master switching.

Circuit 4 consists of three separate conductors (hot, neutral, and ground) and meets the BIFMA/ANSI definition for a dedicated circuit.

Cir.	15-amp		20-amp	
	Model	Model	Model	Model
1	36PER184SB15	36PER184SB20		
2	36PER284SB15	36PER284SB20		
3	36PER384SB15	36PER384SB20		
4	36PER4D84SB15	36PER4D84SB20		

2 and 2 (8-wire):

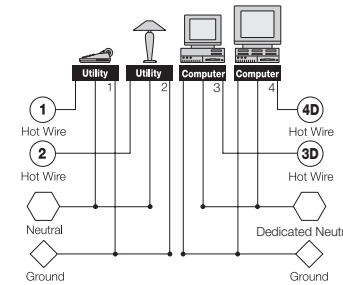

Circuits 1 and 2 provide a pair of designated circuits for general electrical needs.

Circuits 3 and 4 provide a pair of designated circuits for computer applications.

Cir.	15-amp		20-amp	
	Model	Model	Model	Model
1	36PER184SB15	36PER184SB20		
2	36PER284SB15	36PER284SB20		
3	36PER3D84SB15	36PER3D84SB20		
4	36PER4D84SB15	36PER4D84SB20		

Statement of Line	▶ See page 7
Planning	17
Pricing	61
Finishes & Materials	215

2 and 2 Configuration 8-Wire:

120/240V 1 Phase Shared Neutral
Receptacles: 1, 2, 3Δ, 4Δ

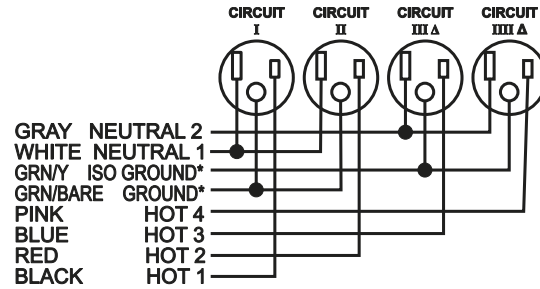

3 and 1 Configuration 8-Wire:

120/240V 1 Phase Shared Neutral
Receptacles: 1, 2, 3, 4Δ

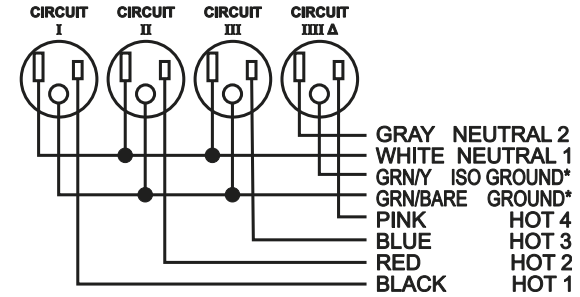

▶ See page

Base Wireway Frames	62
Open-Base Frames	64
To-the-Floor Frames	66
Single-Sided To-the-Floor Frames	68
TV Frames	70
Blank Wireway Covers	71
Mid-Frame Supports	72
Stacking Frames	73
Sliding Privacy Doors	74
Hinged Doors	76
Connectors	77
Stacking Connectors	84
End Trim	87
Top Caps	90
Frameless Glass or Resin	92
Cover Slats	94
Narrate Traxx	95
Standard Fabric Tiles	96
Fire-Rated Fabric Tiles	103
Laminate, Paint, Wood Tiles	110
Glass Tiles	118
Back-Painted Glass Tiles	122
Combination Tiles	127
Markerboard Tiles	155
Metal Tiles	157
Slat Tiles	160
Fold-Down Tiles	162
Technology Tiles	163
End Panels Tiles	165
Electrical Components	190
Cable Management	202
Overhead Storage	203
Narrate Metal Work Tools	207

Base-Wireway Frames

2-High, 3-High, and 3.5-High

GSA Contract Pending

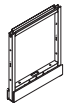

D	W	H	Model	Powered	Non-Powered
2-High					
3¼"	18"	29½"	33P182F	—	\$130
	24"		33P242F	\$238	139
	30"		33P302F	252	148
	36"		33P362F	264	156
	42"		33P422F	279	165
	48"		33P482F	293	173
3-High					
3¼"	18"	42⅛"	33P183F	—	\$160
	24"		33P243F	\$271	172
	30"		33P303F	288	184
	36"		33P363F	305	197
	42"		33P423F	324	210
	48"		33P483F	343	223
3.5-High					
3¼"	18"	49⅓"	33P18H50F	—	\$172
	24"		33P24H50F	\$281	182
	30"		33P30H50F	298	194
	36"		33P36H50F	315	207
	42"		33P42H50F	333	219
	48"		33P48H50F	352	232

Options:

Description	Add/Deduct \$ (per model)					
	18"W	24"W	30"W	36"W	42"W	48"W
No wireway covers	-\$38	-\$44	-\$56	-\$66	-\$74	-\$84
One wireway cover only; punched or non-punched	-\$19	-\$22	-\$28	-\$33	-\$37	-\$42

Mid-frame supports are required wherever Narrate Traxx are used to support tiles and/or overheads. Mid-frame supports can be relocated or additional mid-frame supports may need to be specified separately.

▶ See page 72 to specify.

IMPORTANT: 18"W panels do not accept power entry or receptacles.

For hardwire applications, specify non-powered frame and hardwire electrical components separately.

Standard Includes

- Frame
- Attachment hardware
- Mid-frame supports at 2-high position on 3-high and 3.5-high frames
- Two wireway covers
- Base wireway harness on powered frames

Note: To complete the panel, specify Narrate Traxx, tiles, and top cap separately.

How to Specify

- 1 Model
- 2 Power option:
P = Powered
N = Non-powered
- 3 Type of power system (omit for non-powered):
8S = 8-wire shared neutral
10S = 10-wire shared neutral (+\$40)
10D = 10-wire independent neutral (+\$40)
- 4 Wireway cover punch option:
P1 = 1 power punched, 1 non-punched (n/a 18"W)
P2 = Both power punched (n/a 18"W)
PD1 = 1 power & data punched, 1 non-punched (n/a 18" & 24"W)
PD2 = Both power & data punched (n/a 18" & 24"W)
NP2 = Both non-punched
1NP = 1 non-punched (-\$)
1P = 1 power punched (-\$; n/a 18")
1PD = 1 power & data punched (-\$; n/a 18" & 24")
X = No wireway covers (-\$)
- 5 Wireway cover finish group:
STD = Group 1
STDm = Group M (+10%)
STD21 = Group 21 (+10%)
- 6 Wireway cover finish designator

Base-Wireway Frames

4-High and 5-High

GSA Contract Pending



D	W	H	Model	Powered	Non-Powered
4-High					
3 1/4"	18"	54 ²³ / ₃₂ "	33P184F	—	\$177
	24"		33P244F	\$286	187
	30"		33P304F	305	201
	36"		33P364F	321	213
	42"		33P424F	340	226
	48"		33P484F	361	241
5-High					
3 1/4"	18"	67 ⁵ / ₁₆ "	33P185F	—	\$205
	24"		33P245F	\$320	221
	30"		33P305F	341	237
	36"		33P365F	363	255
	42"		33P425F	386	272
	48"		33P485F	406	286

Options:

Description	Add/Deduct \$ (per model)					
	18"W	24"W	30"W	36"W	42"W	48"W
No wireway covers	-\$38	-\$44	-\$56	-\$66	-\$74	-\$84
One wireway cover only; punched or non-punched	-\$19	-\$22	-\$28	-\$33	-\$37	-\$42

Mid-frame supports are required wherever Narrate Traxx are used to support tiles and/or overheads.

Use of an overhead on a 4- or 5-high frame requires the addition or relocation of mid-frame support. Additional mid-frame supports need to be specified separately.

➤ See page 72 to specify.

IMPORTANT: 18"W panels do not accept power entry or receptacles.

For hardwire applications, specify non-powered frame and hardwire electrical components separately.

Standard Includes

- Frame
- Attachment hardware
- Mid-frame supports at 2-high position on 4-high and 5-high frames
- Wireway covers
- Base wireway harness on powered frames

Note: To complete the panel, specify Narrate Traxx, tiles, and top cap separately.

How to Specify

- 1 Model
- 2 Power option:
P = Powered
N = Non-powered
- 3 Type of power system (omit for non-powered):
8S = 8-wire shared neutral
10S = 10-wire shared neutral (+\$40)
10D = 10-wire independent neutral (+\$40)
- 4 Wireway cover punch option:
P1 = 1 power punched, 1 non-punched (n/a 18"W)
P2 = Both power punched (n/a 18"W)
PD1 = 1 power & data punched, 1 non-punched (n/a 18" & 24"W)
PD2 = Both power & data punched (n/a 18" & 24"W)
NP2 = Both non-punched
1NP = 1 non-punched (-\$)
1P = 1 power punched (-\$; n/a 18")
1PD = 1 power & data punched (-\$; n/a 18" & 24")
X = No wireway covers (-\$)
- 5 Wireway cover finish group:
STD = Group 1
STD M = Group M (+10%)
STD21 = Group 21 (+10%)
- 6 Wireway cover finish designator

Open-Base Frames

2-High, 3-High, and 3.5-High

GSA Contract Pending



D	W	H	Model	Price
2-High				
3 ¹ / ₄ "	18"	29 ¹ / ₂ "	33P182FNOB	\$136
	24"		33P242FNOB	145
	30"		33P302FNOB	156
	36"		33P362FNOB	164
	42"		33P422FNOB	173
	48"		33P482FNOB	183
3-High				
3 ¹ / ₄ "	18"	42 ¹ / ₈ "	33P183FNOB	\$167
	24"		33P243FNOB	181
	30"		33P303FNOB	194
	36"		33P363FNOB	207
	42"		33P423FNOB	220
	48"		33P483FNOB	235
3.5-High				
3 ¹ / ₄ "	18"	49 ¹ / ₃₂ "	33P18H50FNOB	\$181
	24"		33P24H50FNOB	190
	30"		33P30H50FNOB	203
	36"		33P36H50FNOB	218
	42"		33P42H50FNOB	229
	48"		33P48H50FNOB	245

Mid-frame supports are required wherever Narrate Traxx are used to support tiles and/or overheads. Mid-frame supports can be relocated or additional mid-frame supports may need to be specified separately.
▶ See page 72 to specify.

Statement of Line	▶ See page 7
Planning	17
Pricing	61
Finishes & Materials	215

Standard Includes

- Frame
- Attachment hardware
- Mid-frame supports at 2-high position on 3-high and 3.5-high frames

Note: To complete the panel, specify Narrate Traxx, tiles, and top cap separately.

How to Specify

- ① Model
- ② Frame finish group:
STD = Group 1
STD M = Group M (+10%)
STD 21 = Group 21 (+10%)
- ③ Frame finish designator

Open-Base Frames

4-High and 5-High

GSA Contract Pending

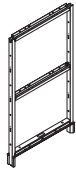

D	W	H	Model	Price
4-High				
3 ¹ / ₄ "	18"	54 ²³ / ₃₂ "	33P184FNOB	\$187
	24"		33P244FNOB	196
	30"		33P304FNOB	211
	36"		33P364FNOB	223
	42"		33P424FNOB	239
	48"		33P484FNOB	252
5-High				
3 ¹ / ₄ "	18"	67 ⁵ / ₁₆ "	33P185FNOB	\$217
	24"		33P245FNOB	231
	30"		33P305FNOB	248
	36"		33P365FNOB	269
	42"		33P425FNOB	285
	48"		33P485FNOB	303

Mid-frame supports are required wherever Narrate Traxx are used to support tiles and/or overheads. Use of an overhead on a 4- or 5-high frame requires the addition or relocation of mid-frame support. Additional mid-frame supports need to be specified separately.
 ▶ See page 72 to specify.

Statement of Line	▶ See page 7
Planning	17
Pricing	61
Finishes & Materials	215

Standard Includes

- Frame
- Attachment hardware
- Mid-frame supports at 2-high position on 4-high and 5-high frames

Note: To complete the panel, specify Narrate Traxx, tiles, and top cap separately.

How to Specify

- ① Model
- ② Frame finish group:
STD = Group 1
STD M = Group M (+10%)
STD 21 = Group 21 (+10%)
- ③ Frame finish designator

To-the-Floor Frames

2-High, 3-High, and 3.5-High

GSA Contract Pending



D	W	H	Model	Price
2-High				
3 1/4"	18"	29 1/2"	33P182FNF	\$142
	24"		33P242FNF	152
	30"		33P302FNF	169
	36"		33P362FNF	172
	42"		33P422FNF	182
	48"		33P482FNF	191
3-High				
3 1/4"	18"	42 1/8"	33P183FNF	\$175
	24"		33P243FNF	190
	30"		33P303FNF	202
	36"		33P363FNF	218
	42"		33P423FNF	230
	48"		33P483FNF	246
3.5-High				
3 1/4"	18"	49 1/32"	33P18H50FNF	\$190
	24"		33P24H50FNF	199
	30"		33P30H50FNF	213
	36"		33P36H50FNF	228
	42"		33P42H50FNF	241
	48"		33P48H50FNF	255

Mid-frame supports are required wherever Narrate Traxx are used to support tiles and/or overheads. Mid-frame supports can be relocated or additional mid-frame supports may need to be specified separately.
▶ See page 72 to specify.

Statement of Line	▶ See page 7
Planning	17
Pricing	61
Finishes & Materials	215

Standard Includes

- Frame
- Attachment hardware
- Mid-frame supports at 2-high position on 3-high and 3.5-high frames

Note: To complete the panel, specify Narrate Traxx, tiles, and top cap separately.

How to Specify

- ① Model

To-the-Floor Frames

4-High and 5-High

GSA Contract Pending

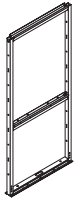
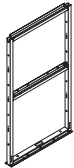

D	W	H	Model	Price
4-High				
3 ¹ / ₄ "	18"	54 ²³ / ₃₂ "	33P184FNF	\$195
	24"		33P244FNF	204
	30"		33P304FNF	221
	36"		33P364FNF	233
	42"		33P424FNF	250
	48"		33P484FNF	265
5-High				
3 ¹ / ₄ "	18"	67 ⁵ / ₁₆ "	33P185FNF	\$225
	24"		33P245FNF	243
	30"		33P305FNF	259
	36"		33P365FNF	281
	42"		33P425FNF	308
	48"		33P485FNF	315

Statement of Line	▶ See page 7
Planning	17
Pricing	61
Finishes & Materials	215

Standard Includes

- Frame
- Attachment hardware
- Mid-frame supports at 2-high position on 4-high and 5-high frames

Note: To complete the panel, specify Narrate Traxx, tiles, and top cap separately.

How to Specify

- ① Model

Mid-frame supports are required wherever Narrate Traxx are used to support tiles and/or overheads. Use of an overhead on a 4- or 5-high frame requires the addition or relocation of mid-frame support. Additional mid-frame supports need to be specified separately.
▶ See page 72 to specify.

Single-Sided To-the-Floor Frames

2-High, 3-High, and 3.5-High

GSA Contract Pending

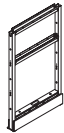
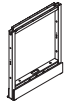

D	W	H	Model	Powered	Non-Powered
2-High					
3 1/4"	18"	29 1/2"	33P182F	—	\$154
	24"		33P242F	\$314	165
	30"		33P302F	339	177
	36"		33P362F	356	186
	42"		33P422F	388	197
	48"		33P482F	402	207
3-High					
3 1/4"	18"	42 1/8"	33P183F	—	\$190
	24"		33P243F	\$355	206
	30"		33P303F	381	219
	36"		33P363F	407	237
	42"		33P423F	440	249
	48"		33P483F	461	266
3.5-High					
3 1/4"	18"	49 1/32"	33P18H50F	—	\$206
	24"		33P24H50F	\$365	216
	30"		33P30H50F	393	231
	36"		33P36H50F	417	247
	42"		33P42H50F	453	262
	48"		33P48H50F	471	276

Models on this page accommodate a to-the-floor tile on one side and a standard tile on the other; one wireway cover is standard.

Mid-frame supports are required wherever Narrate Traxx are used to support tiles and/or overheads. Mid-frame supports can be relocated or additional mid-frame supports may need to be specified separately. [▶See page 72 to specify.](#)

Options:

Description	Add/Deduct \$ (per model)					
	18"W	24"W	30"W	36"W	42"W	48"W
No wireway cover	-\$19	-\$22	-\$28	-\$33	-\$37	-\$42

Statement of Line	▶See page 7
Planning	17
Pricing	61
Finishes & Materials	215

Standard Includes

- Frame
 - Attachment hardware
 - One wireway cover
 - Mid-frame supports at 2-high position on 3-high and 3.5-high frames
- Note: To complete the panel, specify Narrate Traxx, tiles, and top cap separately.*

How to Specify

- 1 Model
- 2 Power option:
PFS = Powered
NFS = Non-powered
- 3 Type of power system (omit for non-powered):
8S = 8-wire shared neutral
10S = 10-wire shared neutral (+\$40)
10D = 10-wire independent neutral (+\$40)
- 4 Wireway cover punch option:
1NP = 1 non-punched
1P = 1 power punched (n/a 18")
1PD = 1 power & data punched (n/a 18" & 24")
X = No wireway covers (-\$)
- 5 Wireway cover finish group:
STD = Group 1
STD M = Group M (+10%)
STD21 = Group 21 (+10%)
- 6 Wireway cover finish designator

Single-Sided To-the-Floor Frames

4-High and 5-High

GSA Contract Pending

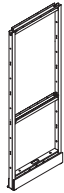

D	W	H	Model	Powered	Non-Powered
4-High Frames					
3 1/4"	18"	54 ^{23/32} "	33P184F	—	\$211
	24"		33P244F	\$389	221
	30"		33P304F	418	240
	36"		33P364F	446	252
	42"		33P424F	484	271
	48"		33P484F	504	288
5-High Frames					
3 1/4"	18"	67 ^{5/16} "	33P185F	—	\$244
	24"		33P245F	\$412	264
	30"		33P305F	443	281
	36"		33P365F	475	305
	42"		33P425F	506	324
	48"		33P485F	537	342

Options:

Description	Add/Deduct \$ (per model)					
	18"W	24"W	30"W	36"W	42"W	48"W
No wireway cover	-\$19	-\$22	-\$28	-\$33	-\$37	-\$42

Models on this page accommodate a to-the-floor tile on one side and a standard tile on the other; one wireway cover is standard.

Mid-frame supports are required wherever Narrate Traxx are used to support tiles and/or overheads. Use of an overhead on a 4- or 5-high frame requires the addition or relocation of mid-frame support. Additional mid-frame supports need to be specified separately.

► See page 72 to specify.

Statement of Line	► See page 7
Planning	17
Pricing	61
Finishes & Materials	215

Standard Includes

- Frame
- Attachment hardware
- One wireway cover
- Mid-frame supports:
 - At 2-high position on 4-high frames and 5-high frames

Note: To complete the panel, specify Narrate Traxx, tiles, and top cap separately.

How to Specify

- 1 Model
- 2 Power option:
 - PFS** = Powered
 - NFS** = Non-powered
- 3 Type of power system (omit for non-powered):
 - 8S** = 8-wire shared neutral
 - 10S** = 10-wire shared neutral (+\$40)
 - 10D** = 10-wire independent neutral (+\$40)
- 4 Wireway cover punch option:
 - 1NP** = 1 non-punched
 - 1P** = 1 power punched (n/a 18")
 - 1PD** = 1 power & data punched (n/a 18" & 24")
 - X** = No wireway covers (-\$)
- 5 Wireway cover finish group:
 - STD** = Group 1
 - STD M** = Group M (+10%)
 - STD 21** = Group 21 (+10%)
- 6 Wireway cover finish designator

TV Frames

GSA Contract Pending

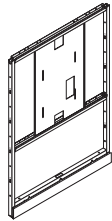

D	W	H	Model	Price
5-High Single Sided				
31/4"	48"	67 ⁵ / ₁₆ "	33P485FTVFS	\$1119

5-High Double Sided				
31/4"	48"	67 ⁵ / ₁₆ "	33P485FTVP	\$963

Options:

Description	Add/Deduct \$ (per model)	
	48"W Single-Sided	48"W Double Sided
No wireway covers	-\$42	-\$84
One wireway cover only; punched or non-punched	n/a	-\$42

TV frames require a 3-high back-painted glass tile on the side with the TV.

➤ See page 126.

Mid-frame supports are required wherever Narrate Traxx are used to support tiles and/or overheads.

Additional mid-frame supports need to be specified separately.

➤ See page 72 to specify.

Standard Includes

- Frame
- Attachment hardware
- Mid-frame support at 2-high and 4-high positions
- Two wireway covers on double-sided model; one wireway cover on single-sided model
- Base wireway harness
- Mounting bracket for TV

Note: To complete the panel, specify Narrate Traxx, tiles, and top cap separately.

How to Specify

- ① Model
- ② Power option:
P = Powered
- ③ Type of power system (omit for non-powered):
8S = 8-wire shared neutral
10S = 10-wire shared neutral (+\$40)
10D = 10-wire independent neutral (+\$40)
- ④ Wireway cover punch option:
P1 = 1 power punched, 1 non-punched (n/a single-sided model)
P2 = Both power punched (n/a single-sided model)
PD1 = 1 power & data punched, 1 non-punched (n/a single-sided model)
PD2 = Both power & data punched (n/a single-sided model)
NP2 = Both non-punched (n/a single-sided model)
1NP = 1 non-punched (-\$ on double-sided)
1P = 1 power punched (-\$ on double-sided)
1PD = 1 power & data punched (-\$ on double-sided)
X = No wireway covers (-\$)
- ⑤ Wireway cover finish group:
STD = Group 1
STD M = Group M (+10%)
STD 21 = Group 21 (+10%)
- ⑥ Wireway cover finish designator

Multi-Frame Blank Exterior Wireway Covers

GSA Contract Pending



<i>W</i>	<i>Model</i>	<i>Price</i>
Blank Wireway Covers		
54"	33P54WCX	\$51
60"	33P60WCX	55
66"	33P66WCX	62
72"	33P72WCX	66
78"	33P78WCX	69
84"	33P84WCX	73
90"	33P90WCX	76
96"	33P96WCX	84

Statement of Line	▶ See page 7
Planning	17
Pricing	61
Finishes & Materials	215

How to Specify

- ① Model
- ② Finish type:
 - STD** = Group 1
 - STD_M** = Group M (+10%)
 - STD₂₁** = Group 21 (+10%)
- ③ Finish designator

Blank wireway covers can be used to cover multiple frames for continuous look. If using multi-frame blank wireway covers, select the option that deletes one or both covers from individual frames that the multi-frame cover will span.

Mid-Frame Supports

GSA Contract Pending



<i>W</i>	<i>Model</i>	<i>Price</i>
Mid-Frame Supports		
18"	33P18MFS	\$32
24"	33P24MFS	36
30"	33P30MFS	40
36"	33P36MFS	44
42"	33P42MFS	48
48"	33P48MFS	52
54"	33P54MFS	56
60"	33P60MFS	60
66"	33P66MFS	64
72"	33P72MFS	70
78"	33P78MFS	72
84"	33P84MFS	74
90"	33P90MFS	76
96"	33P96MFS	79

Mid-frame supports are required wherever Traxx are used to support tiles. Mid-frame supports that are included with frames can be relocated. Specify additional mid-frame supports if needed.

Mid-frame supports 54"–96" are for use with 2 high stacking frames 54"–96" wide.

Statement of Line	▶ See page 7
Planning	17
Pricing	61
Finishes & Materials	215

Standard Includes

- Mid-frame support

How to Specify

- 1 Model

Stacking Frames

GSA Contract Pending

Statement of Line	▶ See page 7
Planning	17
Pricing	61
Finishes & Materials	215



One 1-high or 2-high stacking frame can be added to 1-, 2-, 3-, 4-, or 5-high base frame.

Note: Stacking frames cannot be used on 3.5-high base frames.

Stacking frames 54"–96" are used to span multiple base frames; overall width of base frames must equal width of stacking frame.

Specify end trims and connectors to be equal to the combined height of base and stacking frames.

Specify mid-frame supports separately if using Traxx at the 1-high segment on a 2-high stacking frame.
▶ See page 72.

<i>D</i>	<i>W</i>	<i>H</i>	<i>Model</i>	<i>Price</i>
1-High				
3 ¹ / ₄ "	18"	12 ⁵ / ₈ "	33P181FS	\$96
	24"		33P241FS	100
	30"		33P301FS	104
	36"		33P361FS	109
	42"		33P421FS	114
	48"		33P481FS	118
	54"		33P541FS	133
	60"		33P601FS	148
	66"		33P661FS	165
	72"		33P721FS	180
	78"		33P781FS	187
	84"		33P841FS	195
	90"		33P901FS	202
	96"		33P961FS	210
2-High				
3 ¹ / ₄ "	18"	25 ¹ / ₄ "	33P182FS	\$155
	24"		33P242FS	162
	30"		33P302FS	170
	36"		33P362FS	178
	42"		33P422FS	186
	48"		33P482FS	193
	54"		33P542FS	204
	60"		33P602FS	215
	66"		33P662FS	226
	72"		33P722FS	237
	78"		33P782FS	253
	84"		33P842FS	269
	90"		33P902FS	285
	96"		33P962FS	300

Standard Includes

- Stacking frame
- Attachment hardware

How to Specify

- 1 Model

Sliding Privacy Doors

Non-Locking

GSA Contract Pending

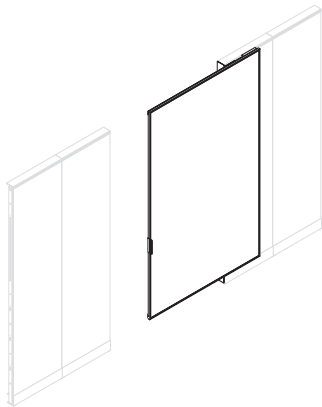
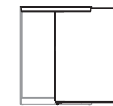
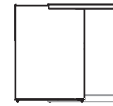

Right-hand door shown.

<i>D</i>	<i>W</i>	<i>H</i>	<i>For Use with Opening</i>	<i>For Use with Host Frame</i>	Right-Hand Model	Left-Hand Model	<i>Price</i>
3.5-High							
3/4"	48 1/8"	49 1/8"	36"W	48"W	33P36H50PDR	33P36H50PDL	\$1198
4-High							
3/4"	48 1/8"	54 7/8"	36"W	48"W	33P364PDR	33P364PDL	\$1249
5-High							
3/4"	48 1/8"	67 3/8"	36"W	48"W	33P365PDR	33P365PDL	\$1386
6-High							
3/4"	48 1/8"	80"	36"W	48"W	33P366PDR	33P366PDL	\$1461
7-High							
3/4"	48 1/8"	92 5/8"	36"W	48"W	33P367PDR	33P367PDL	\$1541
Related Products:							
<i>Model</i>							<i>Price</i>
Door Handle							
2"	2"	5 7/8"				33PPDH	\$86



Door can be shorter than the host frame, but must have a Traxx for the top guide.
Exception: 3.5H door must be used on a 3.5H frame.

Statement of Line	▶ See page 7
Planning	17
Pricing	61
Finishes & Materials	215

Standard Includes

- Door frame: painted aluminum
- Insert: resin
- Hardware kit
- End trim for host panel (wood finish or paint)

How to Specify

Door

- Model
- Door material:
T = Translucent
- Host panel end trim height:
3.5 = 3.5H host panel
4 = 4H host panel
5 = 5H host panel
6 = 6H host panel
7 = 7H host panel
- End trim profile:
F = Flat
- End trim finish price group:
STD = Group 1
STD_M = Group M
STD₂₁ = Group 21
- End trim finish designator
- Door trim paint price group:
STD = Group 1
STD_M = Group M
STD₂₁ = Group 21
- Door trim paint designator

Handle

- Model
- Paint price group:
STD = Group 1
STD_M = Group M
STD₂₁ = Group 21
- Paint designator

Sliding Privacy Doors

Locking

GSA Contract Pending

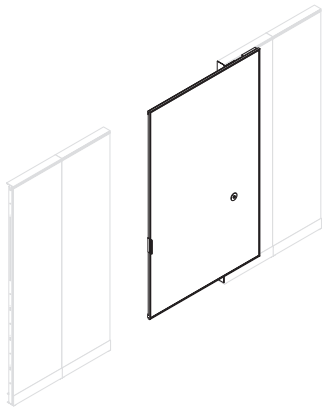
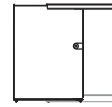

Right-hand door shown.

Hardware kit includes:

- Two medium-hard durometer roller wheels and attachment hardware
- Top guide assembly: painted steel (same color as frame)
- Bottom guide with alignment bracket and guide rod: painted steel (same color as frame)

IMPORTANT: Not intended for use as a security door.

Door can be shorter than the host frame, but must have a Traxx for the top guide.

Exception: 3.5H door must be used on a 3.5H frame.

Door handle
▶ See page 74.

D	W	H	For Use with Opening	For Use with Host Frame	Right-Hand Model	Left-Hand Model	Price
3.5-High							
3/4"	48 1/8"	49 1/8"	36"W	48"W	33P36H50PDRL	33P36H50PDLL	\$1522
4-High							
3/4"	48 1/8"	54 7/8"	36"W	48"W	33P364PDRL	33P364PDLL	\$1573
5-High							
3/4"	48 1/8"	67 3/8"	36"W	48"W	33P365PDRL	33P365PDLL	\$1710
6-High							
3/4"	48 1/8"	80"	36"W	48"W	33P366PDRL	33P366PDLL	\$1785
7-High							
3/4"	48 1/8"	92 5/8"	36"W	48"W	33P367PDRL	33P367PDLL	\$1865

Standard Includes

- Door frame: painted aluminum
- Insert: resin
- Hardware kit
- End trim for host panel: wood or paint
- Locking mechanism:
 - Lock housing, core, and key (key random)
 - Safety release latch
 - Lock plate and attachment hardware

How to Specify

- 1 Model
- 2 End trim material:
P = Paint
- 3 Lock option:
KRB = Key random, black core
KRS = Key random, silver core
KSB = Key specific black (-\$24); specify lock core separately
KSS = Key specific silver (-\$24); specify lock core separately
- 4 Door material:
T = Translucent
- 5 Host panel end trim height:
3.5 = 3.5H host panel
4 = 4H host panel
5 = 5H host panel
6 = 6H host panel
7 = 7H host panel
- 6 End trim profile:
F = Flat
- 7 End trim finish price group:
STD = Group 1
STD_M = Group M
STD₂₁ = Group 21
- 8 End trim finish designator
- 9 Door trim paint price group:
STD = Group 1
STD_M = Group M
STD₂₁ = Group 21
- 10 Door trim paint designator

Hinged Doors

GSA Contract Pending

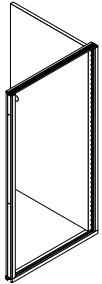

Right hinge shown

<i>W</i>	<i>H</i>	<i>Segment</i>	<i>Model</i>	<i>Price</i>
Wood Doors				
36"	80"	6-high	33P366FAD	\$3860
42"			33P426FAD	4224
Painted Doors				
36"	80"	6-high	33P366FAD	\$3396
42"			33P426FAD	3824

Specify the hinge location (right or left) so that the door will swing in the correct direction. With a right hinge, door will swing away from you to the right; with a left hinge, door will swing away from you to the left.

Top cap must be specified separately to span across door frame.

➤See page 90.

42"W hinged door is recommended for ADA compliance.

Statement of Line	➤See page 7
Planning	17
Pricing	61
Finishes & Materials	215

Standard Includes

- Door: wood or paint (non-metallic)
- Door frame: paint
- Threshold
- Door stop

How to Specify

- 1 Model
- 2 Hinge location:
R = Right
L = Left
- 3 Material:
W = Wood
P = Paint
- 4 Door hardware:
LL2 = Locking lever (+\$445)
X = No lever
- 5 Frame finish:
STD = Group 1
STDM = Group M (+10%)
STD21 = Group 21 (+10%)
- 6 Frame finish designator
- 7 Door finish type:
STD = Group 1
STD2 = Group 2 (+20%)
STD21 = Group 21
- 8 Door finish designator

Connectors

2-Way/L

GSA Contract Pending

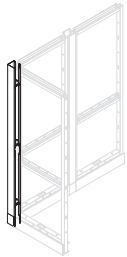
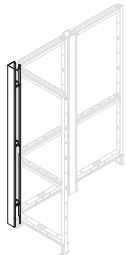

H	Segment	Model	Connector Material		
			Paint	Fabric	Wood
No Wireway Cover					
29½"	2-high	33P22FCL	\$166	\$166	\$397
42⅛"	3-high	33P23FCL	179	179	424
49"	3.5-high	33P2H50FCL	183	183	448
54 ²³ / ₃₂ "	4-high	33P24FCL	185	185	469
67 ⁵ / ₁₆ "	5-high	33P25FCL	188	—	484
79 ²⁹ / ₃₂ "	6-high	33P26FCL	231	—	529
92½"	7-high	33P27FCL	263	—	566
With Wireway Cover					
29½"	2-high	33P22FCLW	\$176	\$176	\$407
42⅛"	3-high	33P23FCLW	189	189	434
49"	3.5-high	33P2H50FCLW	193	193	458
54 ²³ / ₃₂ "	4-high	33P24FCLW	195	195	479
67 ⁵ / ₁₆ "	5-high	33P25FCLW	198	198	494
79 ²⁹ / ₃₂ "	6-high	33P26FCLW	241	—	539
92½"	7-high	33P27FCLW	273	—	576

Standard Includes

- Top cap
- Attachment hardware
- Wireway cover on applicable models

How to Specify

- 1 Model
- 2 Top cap material:
W = Wood
P = Paint
- 3 Connector material:
P = Paint
F = Fabric
W = Wood
- 4 Top cap profile:
F = Flat
- 5 Top cap finish price group:
STD = Group 1
STDM = Group M
STD2 = Group 2
STD21 = Group 21
- 6 Top cap finish designator
- 7 Connector finish price group for wood or paint connector:
STD = Group 1
STDM = Group M
STD2 = Group 2
STD21 = Group 21
- 8 Connector finish designator for wood or paint connector
- 9 Fabric grade for fabric connector, if applicable
- 10 Fabric number for fabric connector, if applicable
- 11 Connector (inside) finish price group:
STD = Group 1
STDM = Group M
STD21 = Group 21
- 12 Connector (inside) finish designator
- 13 Wireway cover finish group (include if applicable):
STD = Group 1
STDM = Group M (+10%)
STD21 = Group 21 (+10%)
- 14 Wireway cover finish designator (include if applicable)

Connectors

3-Way/T

GSA Contract Pending

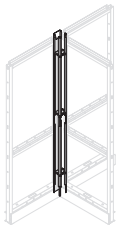
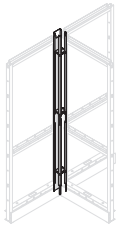

H	Segment	Model	Connector Material		
			Paint	Fabric	Wood
No Wireway Cover					
29½"	2-high	33P32FCT	\$181	181	396
42⅛"	3-high	33P33FCT	187	187	420
49"	3.5-high	33P3H50FCT	193	193	440
54 ²³ / ₃₂ "	4-high	33P34FCT	196	196	460
67 ⁵ / ₁₆ "	5-high	33P35FCT	199	—	467
79 ²⁹ / ₃₂ "	6-high	33P36FCT	241	—	509
92½"	7-high	33P37FCT	268	—	538
With Wireway Cover					
29½"	2-high	33P32FCTW	191	191	406
42⅛"	3-high	33P33FCTW	197	197	430
49"	3.5-high	33P3H50FCTW	203	203	450
54 ²³ / ₃₂ "	4-high	33P34FCTW	206	206	470
67 ⁵ / ₁₆ "	5-high	33P35FCTW	209	209	477
79 ²⁹ / ₃₂ "	6-high	33P36FCTW	251	—	519
92½"	7-high	33P37FCTW	278	—	548

Standard Includes

- Top cap
- Attachment hardware
- Wireway cover on applicable models

How to Specify

- 1 Model
- 2 Top cap material:
W = Wood
P = Paint
- 3 Connector material:
P = Paint
W = Fabric
W = Wood
- 4 Top cap profile:
F = Flat
- 5 Top cap finish price group:
STD = Group 1
STDM = Group M
STD2 = Group 2
STD21 = Group 21
- 6 Top cap finish designator
- 7 Connector finish price group for wood or paint connector:
STD = Group 1
STDM = Group M
STD2 = Group 2
STD21 = Group 21
- 8 Connector finish designator for wood or paint connector
- 9 Fabric grade for fabric connector, if applicable
- 10 Fabric number for fabric connector, if applicable
- 11 Connector (inside) finish price group:
STD = Group 1
STDM = Group M
STD21 = Group 21
- 12 Connector (inside) finish designator
- 13 Wireway cover finish group (include if applicable):
STD = Group 1
STDM = Group M (+10%)
STD21 = Group 21 (+10%)
- 14 Wireway cover finish designator (include if applicable)

Connectors

4-Way/X

GSA Contract Pending

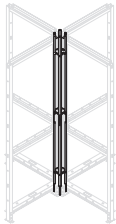

<i>H</i>	<i>Segment</i>	<i>Model</i>	Connector Material		
			<i>Paint</i>	<i>Fabric</i>	<i>Wood</i>
No Wireway Cover					
29½"	2-high	33P42FCX	\$193	—	\$296
42½"	3-high	33P43FCX	199	—	317
49"	3.5-high	33P4H50FCX	206	—	335
54 ²³ / ₃₂ "	4-high	33P44FCX	213	—	354
67 ⁵ / ₁₆ "	5-high	33P45FCX	215	—	356
79 ²⁹ / ₃₂ "	6-high	33P46FCX	257	—	391
92½"	7-high	33P47FCX	284	—	411

Statement of Line	▶ See page 7
Planning	17
Pricing	61
Finishes & Materials	215

Standard Includes

- Wireway cover
- Top cap
- Attachment hardware

How to Specify

- ① Model
- ② Top cap material:
W = Wood
P = Paint
- ③ Top cap profile:
F = Flat
- ④ Top cap finish price group:
STD = Group 1
STD_M = Group M
STD₂ = Group 2
STD₂₁ = Group 21
- ⑤ Top cap finish designator
- ⑥ Connector (inside) finish price group:
STD = Group 1
STD_M = Group M
STD₂₁ = Group 21
- ⑦ Connector (inside) finish designator

Connectors

Straight

GSA Contract Pending

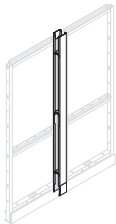
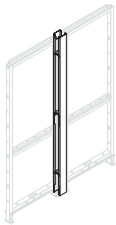

H	Segment	Model	Connector Material		
			Paint	Fabric	Wood
No Wireway Cover					
29½"	2-high	33P12FCS	\$166	\$166	\$397
42⅛"	3-high	33P13FCS	179	179	424
49"	3.5-high	33P1H50FCS	183	183	448
54 ²³ / ₃₂ "	4-high	33P14FCS	185	185	469
67 ⁵ / ₁₆ "	5-high	33P15FCS	188	—	484
79 ²⁹ / ₃₂ "	6-high	33P16FCS	231	—	529
92½"	7-high	33P17FCS	263	—	566
With Wireway Cover					
29½"	2-high	33P12FCSW	\$176	\$176	\$407
42⅛"	3-high	33P13FCSW	189	189	434
49"	3.5-high	33P1H50FCSW	193	193	458
54 ²³ / ₃₂ "	4-high	33P14FCSW	195	195	479
67 ⁵ / ₁₆ "	5-high	33P15FCSW	198	198	494
79 ²⁹ / ₃₂ "	6-high	33P16FCSW	241	—	539
92½"	7-high	33P17FCSW	273	—	576

Standard Includes

- Top cap
- Attachment hardware
- Wireway cover on applicable models

How to Specify

- 1 Model
- 2 Top cap material:
W = Wood
P = Paint
- 3 Connector material:
P = Paint
W = Wood
- 4 Top cap profile:
F = Flat
- 5 Top cap finish price group:
STD = Group 1
STD_M = Group M
STD2 = Group 2
STD21 = Group 21
- 6 Top cap finish designator
- 7 Connector finish price group for wood or paint connector:
STD = Group 1
STD_M = Group M
STD2 = Group 2
STD21 = Group 21
- 8 Connector finish designator for wood or paint connector
- 9 Fabric grade for fabric connector, if applicable
- 10 Fabric number for fabric connector, if applicable
- 11 Connector (inside) finish price group:
STD = Group 1
STD_M = Group M
STD21 = Group 21
- 12 Connector (inside) finish designator
- 13 Wireway cover finish group (include if applicable):
STD = Group 1
STD_M = Group M (+10%)
STD21 = Group 21 (+10%)
- 14 Wireway cover finish designator (include if applicable)